

Compact SCR Power Controller

EPack (Two Phase)

HA032715 Issue 01

11/2016



Eurotherm[®]

by **Schneider** Electric

Table of Contents

- Table of Contents 3
- Legal Information 9
- Safety Information 11
 - Important Information..... 11
- Safety Notes 12
 - SELV 14
 - Symbols Used in the Instrument Labelling..... 15
- Introduction 16
 - Unpacking the Units..... 16
 - Order Code 17
 - Basic Product Coding 17
 - Software Upgrade Options..... 18
- Installation 19
 - Mechanical Installation..... 19
 - Fixing details 19
 - Mounted clearance dimensions 19
 - Bulkhead Mounting 20
 - 32A and 63A Units 20
 - 80A, 100A and 125A Units 21
 - DIN Rail Mounting..... 22
 - 32A and 63A Units 22
 - 80A, 100A and 125A Units 22
 - Dimensions 23
 - 16A to 32A unit dimensions 23
 - 40A to 63A unit dimensions 24
 - 80A to 100A unit dimensions 25
 - 125A unit dimensions..... 26
 - Summary - all units (16A - 125A)..... 27
 - Electrical Installation 28
 - Connection Details..... 28
 - Auxiliary supply 30
 - 24V ac/dc auxillary supply 30
 - 85 to 550Vac auxiliary supply 30
 - Auxillary supply fuse protection 31
 - Connections (Supply Power and Load) 32
 - 16A to 32A and 40A to 63A Units 32
 - 80A, 100A and 125A units 33
 - Load Configurations..... 34
 - Delta 34
 - Closed Delta 34
 - Star 35
 - Star without Neutral 35
 - Signal wiring..... 36
 - Enable Input..... 36
 - Alarm Acknowledge 36
 - Main Setpoint..... 36
 - Relay Output..... 37
 - I/O Input & Output Details 38
 - Network Communications 39
 - Ethernet Wiring 39
 - Communications Pinouts 39
- Operator Interface 41
 - Display 41

- Status area..... 42
- Softkey icons..... 42
- Pushbuttons 43
 - Pushbutton functions 43
 - Menu item value selection 43
- Front Panel Event Indication 44
 - Instrument events 44
 - Indication alarms..... 44
 - System alarms 44
 - Process alarms 44
- Quickcode 45**
 - Quickcode Menu Parameters..... 46
 - Firing modes definitions 47
 - Logic 47
 - Burst Fixed Firing..... 47
 - Burst Variable Firing..... 48
 - Phase Angle Control 48
 - Intelligent (IHC) Mode 48
 - 50% Duty Cycle 49
 - 33% Duty Cycle 49
 - 66% Duty Cycle 49
 - Feedback type 50
 - Transfer Mode..... 50
 - Limitation features..... 50
 - Firing Angle Limiting 50
 - Duty Cycle Limiting 51
 - Chop Off..... 51
- Communications 53**
 - Ethernet/IP 53
 - Introduction 53
 - EPack Power Controller EtherNet/IP Features 53
 - CIP Object Support 54
 - Setting Up the EPack Power Controller Unit..... 54
 - Dynamic IP Addressing 55
 - Fixed IP Addressing 55
 - Default Gateway 56
 - Data Exchange Mapping..... 56
 - Configuring The Cyclic (Implicit) Data Exchange..... 57
 - Setting Up The Master 59
 - Cyclic (Implicit) Data Exchange 59
 - EDS File Import 59
 - Network Driver - Configuration (using RSLinx Classic Lite) 62
 - Establishing Communications 65
 - Data Formats 65
 - The EDS File..... 66
 - Troubleshooting 66
 - Modbus 67
 - Overview 67
 - Protocol Basics 67
 - Parameter Resolution 68
 - Reading of Large Numbers..... 69
 - Wait Period..... 69
 - Latency 70
 - Configuration Mode Parameters 70
 - Modbus Advanced Topics 71
 - Access to Full Resolution Floating Point and Timing Data 71
 - Data Types Used In EPack Power Controller Units 72
 - Enumerated, Status Word, and Integer parameters 72
 - Floating Point Parameters 72
 - Time Type Parameters..... 73
 - ETHERNET (MODBUS TCP) 74

Instrument setup	74
Dynamic IP Addressing	74
Fixed IP Addressing	75
Default Gateway	75
Preferred Master	75
iTools Setup	75
Automatic Configuration	75
Manual Configuration	76
PROFINET	77
PROFINET Features (certification pending)	77
PROFINET Wiring	78
iTools Connection	79
Setting up the EPack Controller for Profinet	79
Commissioning using DCP protocol	79
Commissioning using 'Fixed' IP Mode'	80
Setting up the IP configuration via iTools	81
Device Name	81
Device Name via the DCP protocol	81
Display of the Device Name on the EPack screen	82
Display of the Device Name in iTools	82
Other DCP Services	82
Flash LED (also called "Flash Once")	82
Reset to factory	82
Cyclic Data Exchange (PROFINET IO Data)	83
Configuring the Cyclic (IO Data) Data Exchange	83
Acyclic Data Exchange (Record Data)	84
PROFINET Acyclic Readings	84
Constraints on the Parameters	85
Data Formats	85
The GSD File	86
Alarm Notification	86
Configuration from the Front Panel	88
Menu Pages	88
Comms menu	89
Meas menu	91
Adjust menu	92
Info menu	94
Strat menu	95
PLF menu	96
Settings menu	97
Alarms menu	98
Alm Disable menu	99
Alm Stop menu	100
Alm Relay menu	101
DI Stat menu	102
Access menu	103
Access to Menus	104
Access to OEM security	104
Configuration using iTools	106
Introduction	106
Overview	106
Access Menu	107
Alarm Configuration	109
Communications Configuration	110
Control Configuration	113
Control setup menu	114
Parameters	114
Control Main menu	115
Parameters	115
Control limit configuration	116
Parameters	116

Control diagnostic menu	117
Parameters	117
Control Alarm disable menu	117
Parameters	117
Control Alarm Detection Parameters	118
Parameters	118
Control Alarm signalling parameters	118
Parameters	118
Control Alarm Latch parameters	119
Parameters	119
Control Alarm Acknowledgement parameters	119
Parameters	119
Control Alarm Stop parameters.....	120
Parameters	120
AlmRelay, Control Alarm Relay	120
Parameters	120
Counter Configuration	121
Parameters	121
Cascading Counters	122
Energy Configuration	123
Parameters	123
Resolution	124
Fault Detection Menu	125
Parameters	125
Firing Output Menu	127
Examples	128
Input/Output (IO) Configuration.....	129
Analogue Input configuration	130
Ai Main	130
Parameters	130
AlmDis	131
Example.....	131
AlmDet	131
AlmSig	131
AlmLat.....	131
AlmAck.....	131
AlmStop	131
AlmRelay	131
Digital Input configuration	132
Parameters	132
Relay status	133
Parameters	133
Instrument Configuration Menu.....	134
Instrument Display configuration.....	134
Parameters	134
Instrument Config configuration	135
Parameters	135
Instrument configuration	136
Parameters	136
Scaling Factor	137
SetProv Example	137
IP Monitor Configuration	138
Parameters	138
Lgc2 (Two Input Logic Operator) Menu	139
Lgc2 Parameters.....	139
Lgc8 (Eight-input Logic Operator) Configuration.....	141
Parameters	141
Inversion schematic	141
Invert input decoding table.....	142
Math2 Menu	143
Math2 Parameters	143
Modulator Configuration.....	145
Modulator parameters.....	145

Network Configuration.....	146
Network Meas Menu	147
Parameters	147
Network Setup configuration	149
Parameters	149
Network Alarms.....	151
AlmDis	151
Network AlmDet Submenu	151
Network Almsig Submenu.....	151
Network AlmLat Submenu	151
Network Almack Submenu.....	151
Network Almstop Submenu	152
Network Almrelay Submenu	152
Qcode.....	153
Parameters	153
Setprov Configuration Menu	155
Setpoint provider parameters.....	155
Timer Configuration.....	157
Parameters	157
Timer examples	158
Totaliser Configuration	159
Parameters	159
User Value Configuration Menu	160
User Value parameters	160
Using iTools	161
iTools connection.....	161
Automatic detection	161
Ethernet (Modbus TCP) communications	162
Direct Connection	164
WIRING	164
Scanning for Instruments	166
Graphical Wiring Editor	167
Toolbar	168
Wiring editor operating details	168
Component Selection	168
Block Execution Order	169
Function Blocks	169
Wires.....	172
Routing wires	173
Wire Colours	174
Thick Wires	174
Comments	174
MONITORS	175
Downloading	176
Colours	176
Diagram context menu	177
Compounds	178
Tool Tips.....	179
Parameter Explorer	180
Parameter explorer detail.....	181
Explorer tools	182
Context Menu.....	182
Fieldbus Gateway	183
Watch/Recipe Editor	185
Creating a Watch List.....	185
Adding parameters to the Watch List	185
Data Set Creation	186
Watch Recipe toolbar icons	187
Watch/Recipe Context Menu	187
Parameter Addresses (Modbus)	188
Introduction	188

Parameter Types	188
Parameter Scaling.....	188
Parameter List.....	188
Alarms	189
System Alarms	189
Missing mains	189
Thyristor short circuit.....	189
Over temperature.....	189
Network dips	189
Mains frequency fault	189
Chop Off alarm.....	189
Process Alarms	190
Total Load Failure (TLF)	190
Closed Loop alarm.....	190
Alarm input.....	190
Over current detection	190
Over Voltage Alarm	190
Under Voltage Alarm	190
Partial Load Failure (PLF).....	191
Partial Load Unbalance (PLU)	191
Indication Alarms	191
Process Value Transfer active	191
Limitation active	191
Load Over-Current.....	191
Maintenance	192
Precautions	192
Branch-circuit Protection and Safety Overload Protection.....	192
Preventive Maintenance	192
Fusing	193
Fuse holder dimensions.....	195
Instrument upgrade	197
iTools upgrade.....	197
Firmware upgrade.....	198
Software upgrade.....	199
Obtaining a Passcode via Telephone.....	199
Obtaining a Passcode via itools.....	199
EPack Licence Notice	200
Technical Specification	201
Standards.....	201
Installation Categories	201
Specification.....	202

Legal Information

All rights are strictly reserved. No part of this document may be reproduced, modified, or transmitted in any form by any means, nor may it be stored in a retrieval system other than for the purpose to act as an aid in operating the equipment to which the document relates, without prior written permission of the manufacturer.

Eurotherm, the Eurotherm by Schneider Electric logo, Chessell, EurothermSuite, Mini8, Eycon, Eyris, EPower, EPack nanodac, piccolo, versadac, optivis, Foxboro, and Wonderware are trademarks of Invensys plc, its subsidiaries and affiliates. All other brands may be trademarks of their respective owners.

Eurotherm Limited pursues a policy of continuous development and product improvement. The specifications in this document may therefore be changed without notice. The information in this document is given in good faith, but is intended for guidance only. Eurotherm Limited will accept no responsibility for any losses arising from errors in this document.

Safety Information

Important Information

Read these instructions carefully and look at the equipment to become familiar with the device before trying to install, operate, service, or maintain it. The following special messages may appear throughout this manual or on the equipment to warn of potential hazards or to call attention to information that clarifies or simplifies a procedure.





The addition of either symbol to a “Danger” or “Warning” safety label indicates that an electrical hazard exists which will result in personal injury if the instructions are not followed.



This is the safety alert symbol. It is used to alert you to potential personal injury hazards. Obey all safety messages that follow this symbol to avoid possible injury or death.

 DANGER
DANGER indicates a hazardous situation which, if not avoided, will result in death or serious injury.

 WARNING
WARNING indicates a hazardous situation which, if not avoided, could result in death or serious injury.

 CAUTION
CAUTION indicates a hazardous situation which, if not avoided, could result in minor or moderate injury.

NOTICE
NOTICE is used to address practices not related to physical injury.

Safety Notes

DANGER

BRANCH-CIRCUIT PROTECTION & SAFETY OVERLOAD PROTECTION

1. This product does not contain any branch-circuit protection or internal safety overload protection. The installer must add branch-circuit protection upstream of the unit, and provide external or remote safety overload protection to the end installation. Such branch-circuit and safety overload protection must comply with applicable local regulations.
UL: The above mentioned branch-circuit protection is necessary for compliance with National Electric Code (NEC) requirements.
2. The cables used to connect the EPack's auxiliary supply and voltage reference must be correctly protected by branch-circuit protection. It is the responsibility of the installer to add branch-circuit protection. Such branch-circuit protection must comply with applicable local regulations.

HAZARD OF ELECTRICAL SHOCK, EXPLOSION OR ARC FLASH

3. Eurotherm shall not be held responsible for any damage, injury, losses or expenses caused by inappropriate use of the product (EPack), or failure to comply with these instructions.
4. If the product is used in a manner not specified by the manufacturer, the protection provided by the product might be impaired.
5. Disassembling the product is strictly forbidden.
6. The product must be installed and maintained by suitably qualified personnel, authorized to work in an industrial low voltage environment.
7. The product is not suitable for isolation applications, within the meaning of EN60947-1.
8. EPack alarms protect thyristors and loads against abnormal operation, and provide the user with valuable information regarding the type of fault. Under no circumstances must these alarms be regarded as a replacement for proper personnel protection. It is strongly recommended that the installing authority include independent, system-safety mechanisms to protect both personnel and equipment against injury or damage, and that such safety mechanisms be regularly inspected and maintained. Consult the EPack supplier for advice.
9. The product is designed to be installed in a cabinet connected to the protective earth ground according to IEC60364-1 and IEC60364-5-54 or applicable national standards.
10. Electrically conductive pollution must be excluded from the cabinet in which the product is mounted. To ensure a suitable atmosphere in conditions of conductive pollution, fit adequate air conditioning/filtering/cooling equipment to the air intake of the cabinet, e.g. fitting fan-cooled cabinets with a fan failure detection device or a thermal safety cut-out.
11. Before carrying out any wiring to the product, it must be ensured that all relevant power and control cables, leads or harnesses are isolated from voltage sources.
12. Before any other connection is made, the protective earth ground terminal shall be connected to a protective conductor. Wire conductor cross sections must comply with table 9 of IEC60947-1 or NEC Article 310 Table 310-16.
U.L.: The earth connection must be made using a UL-listed ring type crimp. The cables used must be rated 90 stranded copper only.
13. The protective earth ground connections and power terminals must be tightened according to the torque values defined in Table 1, "Connection Details," on page 29. Appropriate regular inspections must be performed.

Failure to follow these instructions will result in death or serious injury.

 **DANGER****HAZARD OF ELECTRICAL SHOCK, EXPLOSION OR ARC FLASH**

14. Any interruption of the protective earth ground conductor inside or outside the product, or disconnection of the protective earth ground terminal is likely to make the product dangerous under some conditions. Intentional interruption is prohibited. Whenever it is likely that protection has been impaired, the unit shall be made inoperative, and secured against accidental operation. The manufacturers nearest service centre must be contacted for advice.
15. Power connections: wire conductor cross sections must comply with table 9 of IEC60947-1 or NEC Article 310 Table 310-16. The cables used must be rated 90°C stranded copper only.
16. If fitted, the 85Vac to 550Vac auxiliary supply shall be protected by a supplemental fuse or by branch circuit fuses as listed in Table 2, "Auxiliary supply, fuse protection," on page 31.
17. The EPack's rated short-circuit conditional current is 100kA for co-ordination type 2. Nevertheless, if opening of either the branch circuit protective or the supplemental (high speed) fuses occurs, the product shall be examined by suitably qualified personnel and replaced if damaged.
18. The maximum voltage between any pole of the power supply and terminals 1/L1, 3/L2 and Vref shall be lower than 550Vac. The maximum voltage between any pole of the power supply and protective earth ground shall be lower than 550Vac (rated insulation voltage 500V).
19. Connection of two conductors in the same terminal is not permitted.

Failure to follow these instructions will result in death or serious injury.

**WARNING**

1. Signal and power voltage wiring must be kept separate from one another. Where this is impractical, shielded cables should be used for the signal wiring.
2. Do not use the Vref terminal to replicate voltage signals (in a 'daisy chain'), as the PCB track between the two poles is not designed to withstand short-circuit.
3. The product shall have one of the following as a disconnecting device, fitted within easy reach of the operator, and labelled as the disconnecting device:
 - A switch or circuit breaker which complies with the requirements of IEC60947-1 and IEC60947-3.
 - A separable coupler which can be disconnected without the use of a tool.
4. The product is designed to be mounted vertically. There must be no obstructions (above or below) which could reduce or hamper airflow. If more than one instance of the product is located in the same cabinet, they must be mounted in such a way that air from one unit is not drawn into another.
5. To reach the thermal performance the gap between two EPacks must be at minimum 10mm.
6. Under some circumstances, the EPack heatsink temperature may rise above 50°C and it can take up to 15 minutes to cool after the product is shut down. Give consideration to additional warnings and barriers to prevent injury.
7. This product has been designed for environment A (Industrial). Use of this product in environment B (domestic, commercial and light industrial) may cause unwanted electromagnetic disturbances in which cases the installer may be required to take adequate mitigation measures.
8. The 24V auxiliary supply must be derived from a SELV or PELV circuit, see [SELV \(page 14\)](#) for definition.
9. To ensure that EPack complies with Electromagnetic Compatibility requirements, ensure that the panel or DIN rail to which it is attached is correctly grounded. The ground connection, designed to ensure ground continuity, is not in any way a substitute for the protective earth ground connection.
10. **IP20**: In order to maintain IP20 protection, the stripped length of the power cables from the supply and to the load must be adapted according to the insulation thickness.
11. If the upper and/or lower access door is open and if voltage reference connector is removed, IP20 is compromised and the product is IP10.
12. Breakaway features have been designed into the product especially to improve the IP20 rating. These features should be removed only for cable cross sections of 50mm² or more.

Failure to follow these instructions can result in death, serious injury or equipment damage.

SELV









SELV is defined (in IEC60947-1) as an electrical circuit in which the voltage cannot exceed 'ELV' under normal conditions or under single fault conditions, including earth ground faults in other circuits. The definition of ELV is complex as it depends on environment, signal frequency, etc. See IEC 61140 for further details.

The I/O connector (5-way) & auxiliary supply (24V ac/dc, 2-way) are compliant to the SELV requirements.

The alarm relay output is compliant to the SELV requirements; it can be connected to SELV or to voltage up to 230V (Rated insulation voltage U_i : 230V)

Symbols Used in the Instrument Labelling

One or more of the symbols below may appear as a part of the instrument labelling.

	Protective conductor terminal		Risk of electric shock
	AC supply only		Precautions against static electrical discharge must be taken when handling this unit
	Underwriters Laboratories listed mark for Canada and the US		Refer to the manual for instructions
	Do not touch Heatsink Hot Surface		CE Mark. Indicates compliance with the appropriate European Directives and Standards

Introduction

This document describes the installation, operation and configuration of a 2 phase EPack power controller unit. The unit includes the following analogue and digital inputs and outputs, fitted as standard:

- Two digital inputs (contact closure or voltage level), of which one of the digital inputs can be configured as 10v user output
- One analogue input
- One change-over relay under software control, configurable by the user.
- Also fitted are a pair of RJ45 Ethernet connectors for communications with a controlling pc or with other units.

Chapter [Installation](#) provides details on connector locations and pinouts.

The operator interface consists of a 1.44 inch square TFT display and four push buttons for navigation and data selection.

The 2 phase EPack power controller comes in four versions with maximum load currents of: 32A, 63A, 100A and 125A.

The supply voltage for the units can be specified as either low voltage (24V ac/dc) or line voltage (85 to 550V ac). The choice is made at time of order and cannot be changed in the field.

Unpacking the Units

The units are despatched in a special pack, designed to give adequate protection during transit. If any of the outer boxes show signs of damage, they should be opened immediately, and the instrument examined. If there is evidence of damage, the instrument should not be operated and the local representative contacted for instructions.

After the instrument has been removed from its packing, the packing should be examined to ensure that all accessories and documentation have been removed. The packing should then be stored against future transport requirements.

Order Code

E-Pack power controller is ordered using a short code for hardware and chargeable software options code.

Basic Product Coding



Model	
EPACK-2PH	Power Controller
1 Maximum current	
16A	16 amps
25A	25 amps
32A	32 amps
40A	40 amps
50A	50 amps
63A	63 amps
80A	80 amps
100A	100 amps
125A	125 amps
2 Auxiliary Power Supply	
500V	500V max
24V	24V ac/dc
3 Reserved	
XXX	Reserved
4 Control Option	
V2	V ² control (standard)
I2	I ² control
PWR	Power control
5 Transfer Option	
XXX	-
TFR	I ² Transfer
6 Energy Option	
XXX	-
EMS	Energy measurement

7 Comms Option	
TCP	Modbus TCP (standard)
IP	Ethernet IP
8 OEM Security	
XXX	None
OEM	OEM Security
9 Warranty	
XXX	Standard Warranty
WL005	5 Year Warranty
USWL3	US Extended Warranty
10 Custom Labelling	
XXX	Standard (Eurotherm)
FXXXX	Special Label
11 Graphical wiring	
XXX	None
GWE	Graphical Wiring Editor
12 Fuse	
XXX	Without
HSP	High Speed fuse without microswitch
HSM	High Speed fuse with microswitch
13 Configuration	
XXXXX	Default
LC	Long code

Optional configuration	
14 Nominal load current	
nnnA	1 - Value field 1
15 Nominal line voltage	
100V	100 volts
110V	110 volts
115V	115 volts
120V	120 volts
127V	127 volts
200V	200 volts
208V	208 volts
220V	220 volts
230V	230 volts
240V	240 volts
277V	277 volts
380V	380 volts
400V	400 volts
415V	415 volts
440V	440 volts
460V	460 volts
480V	480 volts
500V	500 volts
16 Load configuration	
3S	Star without neutral
3D	Closed delta
17 Load type	
XX	Resistive
TR	Transformer primary
18 Heater type	
XX	Resistive
CSI	Silicon Carbide
SWIR	Short Wave Infra-Red
19 Firing mode	
BF	Variable Modulation Burst firing (default 16 cycles)
FX	Fix modulation period (default 2 seconds)
LGC	Logic mode
20 Analog Input Function	
XX	None
SP	Setpoint
HR	Setpoint limit
TS	Current transfer span
21 Analog input type	
0V	0-10 volts
1V	1-5 volts
2V	2-10 volts
5V	0-5 volts
0A	0-20 mA
4A	4-20mA
22 Digital Input 2 Function	
XX	None
LG	Setpoint for logic mode
AK	Alarm acknowledgement
RS	Remote Setpoint selection
FB	Fuse Blown
SU	10V supply
23 Reserved	
XXX	Reserved

NOTE:

Communication option PROFINET is not currently available at version 5.0 release.

Software Upgrade Options



1	Serial number instrument
nnnn	Serial number

2	Current ratings
XXX	No change
16A-25A	Upgrade 16A to 25A
16A-32A	Upgrade 16A to 32A
25A-32A	Upgrade 25A to 32A
40A-50A	Upgrade 40A to 50A
40A-63A	Upgrade 40A to 63A
50A-63A	Upgrade 50A to 63A
80A-100A	Upgrade 80A to 100A

3	Control option
XXX	no change
V2-I2	Upgrade V ² to I ²
V2-PWR	Upgrade V ² to PWR
I2-PWR	Upgrade I ² to PWR

4	Transfer option
XXX	No change
TFR	I ² transfer

5	Energy option
XXX	No change
TFR	Energy measurement

6	Comms option
XXX	No change
IP	Ethernet IP

7	Graphical wiring
XXX	No change
GWE	Graphical wiring editor

8	OEM security
XXX	No change
OEM	OEM security

Installation

Mechanical Installation

Fixing details

The product is designed to operate at an operating temperature not exceeding 45°C at an altitude not exceeding 1000 metres and not exceeding 40°C at an altitude not exceeding 2000 metres.

 **DANGER**

The product is designed to be installed in a cabinet connected to the protective earth ground according to IEC60364-1 and IEC60364-5-54 or applicable national standards.

Electrically conductive pollution must be excluded from the cabinet in which the product is mounted. To ensure a suitable atmosphere in conditions of conductive pollution, fit adequate air conditioning/filtering/cooling equipment to the air intake of the cabinet, e.g. fitting fan-cooled cabinets with a fan failure detection device or a thermal safety cut-out.

Failure to follow these instructions will result in death or serious injury.

 **WARNING**

The product is designed to be mounted vertically. There must be no obstructions (above or below) which could reduce or hamper airflow. If more than one instance of the product is located in the same cabinet, they must be mounted in such a way that air from one unit is not drawn into another.

To reach the thermal performance the gap between two E-Packs must be at minimum 10mm.

Failure to follow these instructions can result in death, serious injury or equipment damage.

Figures 4 to 7 show dimensions for the various units.

The units are designed for DIN Rail or bulkhead mounting using the fixings supplied.

Mounted clearance dimensions

Phase	2 phase			
Amps:	16 - 32A	40 - 63A	80 - 100A	125A
E-Pack clearance dimensions mm (inches):				
between cable tray and E-Pack	70 (2.76)	100 (3.94)	150 (5.91)	150 (5.91)
between two cable trays	306 (12.05)	366 (14.41)	530 (20.87)	530 (20.87)
between or side by side another E-Pack	10 (.39)	10 (.39)	10 (.39)	10 (.39)

Bulkhead Mounting

32A and 63A Units

For Bulkhead mounting, fit the upper bracket 'A' to the rear of the unit by removing screw 'B' x2 and associated shake proof washers, offering the bracket up to the unit, and then securing it by installing x2 screw 'B' ensuring that the bracket is correctly oriented (as shown) and that the shakeproof washers are fitted between the screw head and the bracket.

The relevant screwdriver should have a 3mm AF hexagonal bit. The recommended tightening torque is 1.5 Nm (1.1 lb-ft). To mount, secure using x2 M5 screws and shakeproof washers using the top and bottom mount points.

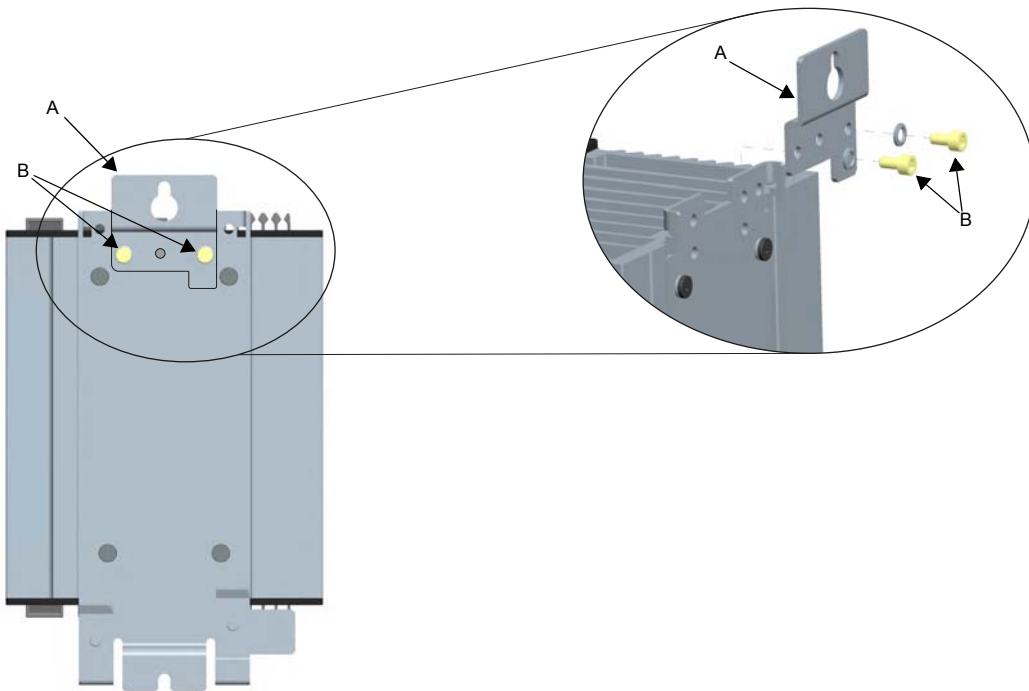

Figure 1: Fitting upper bulkhead mounting bracket (32A unit shown; 63A units similar)

80A, 100A and 125A Units

For bulkhead mounting, brackets 'A' and 'B' on the rear of the unit are used to mount the product. Secure using x3 M6 screws and shakeproof washers using the top and bottom mount points.

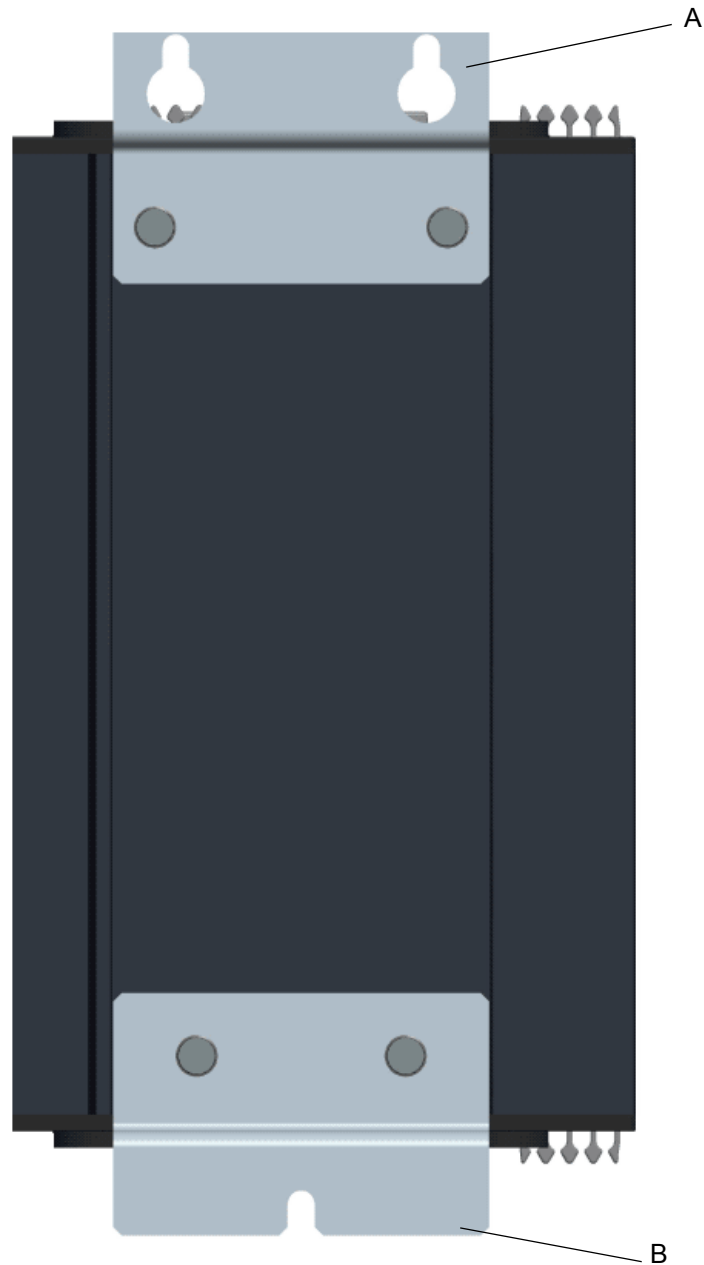

Figure 2: Bulkhead mounting (80A/100A unit shown; 125A similar)

DIN Rail Mounting

32A and 63A Units

The 32A and 63A units can be mounted using two horizontal, parallel, 7.5 mm or 15 mm DIN rails. Locate the upper mounting hooks 'A' (x2) on the upper DIN rail 'B'. To secure the unit against the lower DIN rail 'C', slide the lower mounting catches 'D' (x2) upwards and tighten the fixing screws 'E' (x2) to the recommended tightening torque of 3 Nm (2.2 lb ft).

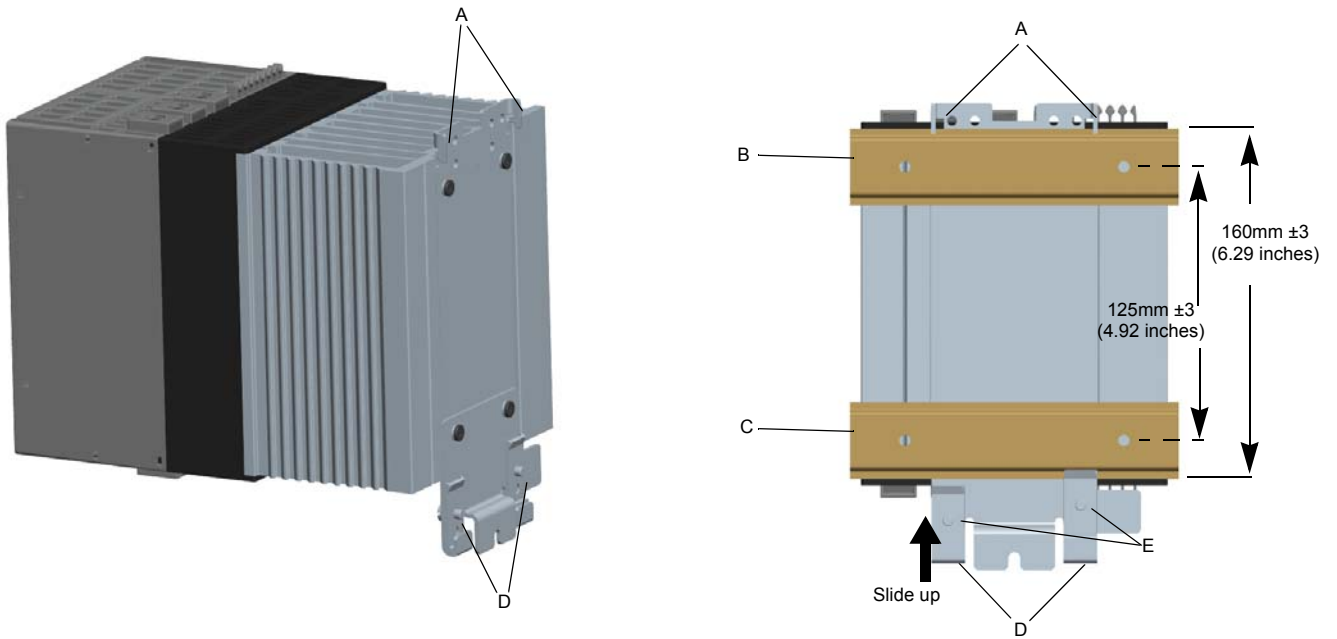

Figure 3: DIN rail mounting (32A unit shown; 63A units similar)

80A, 100A and 125A Units

The higher power units cannot be mounted using any type of DIN rail configuration due to the size and relative mass.

See "Bulkhead Mounting" on page 20 for further details.

Dimensions

16A to 32A unit dimensions

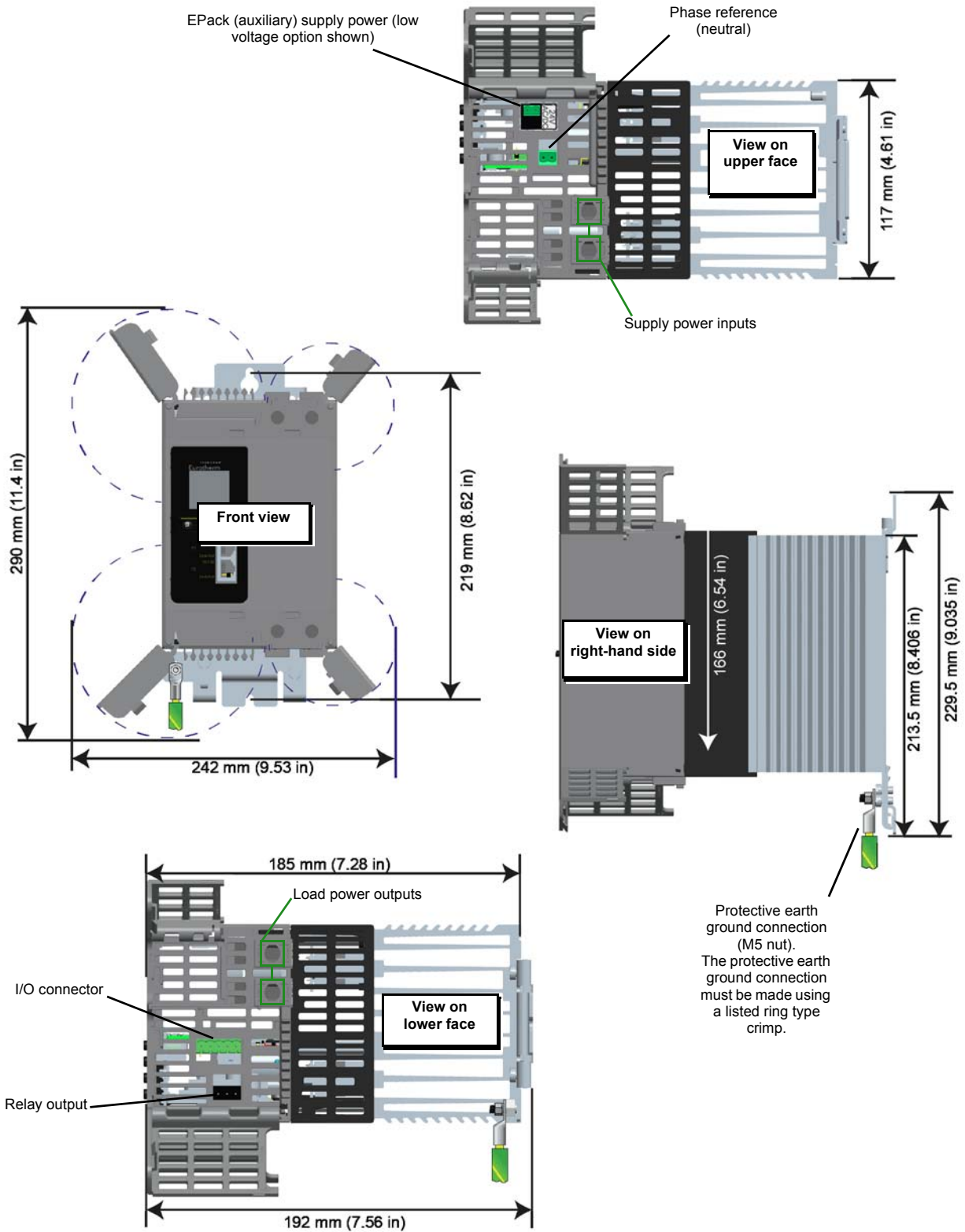

Figure 4: Mechanical installation details (16A to 32A units).

40A to 63A unit dimensions

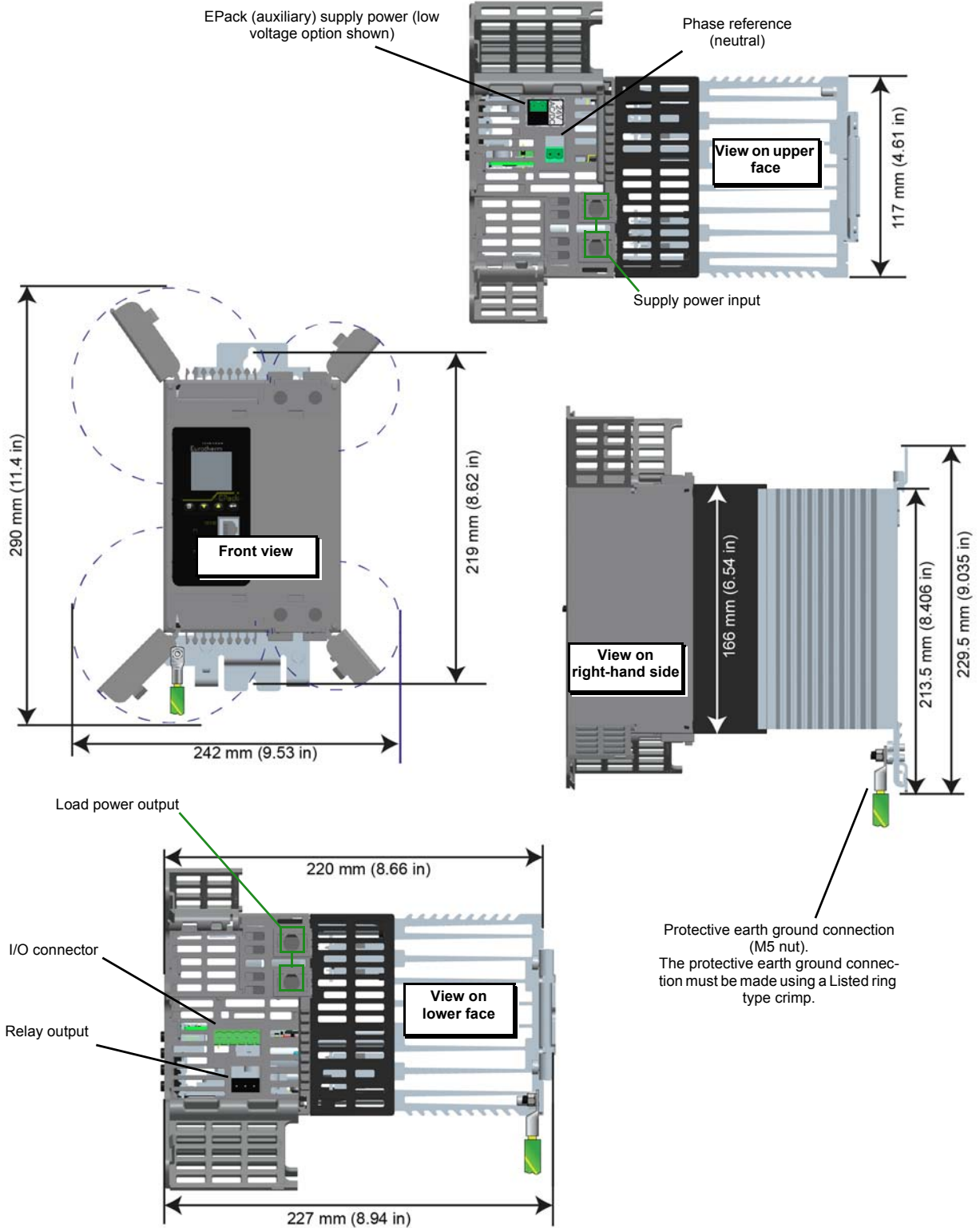

Figure 5: Mechanical installation details (40A to 63A units).

80A to 100A unit dimensions

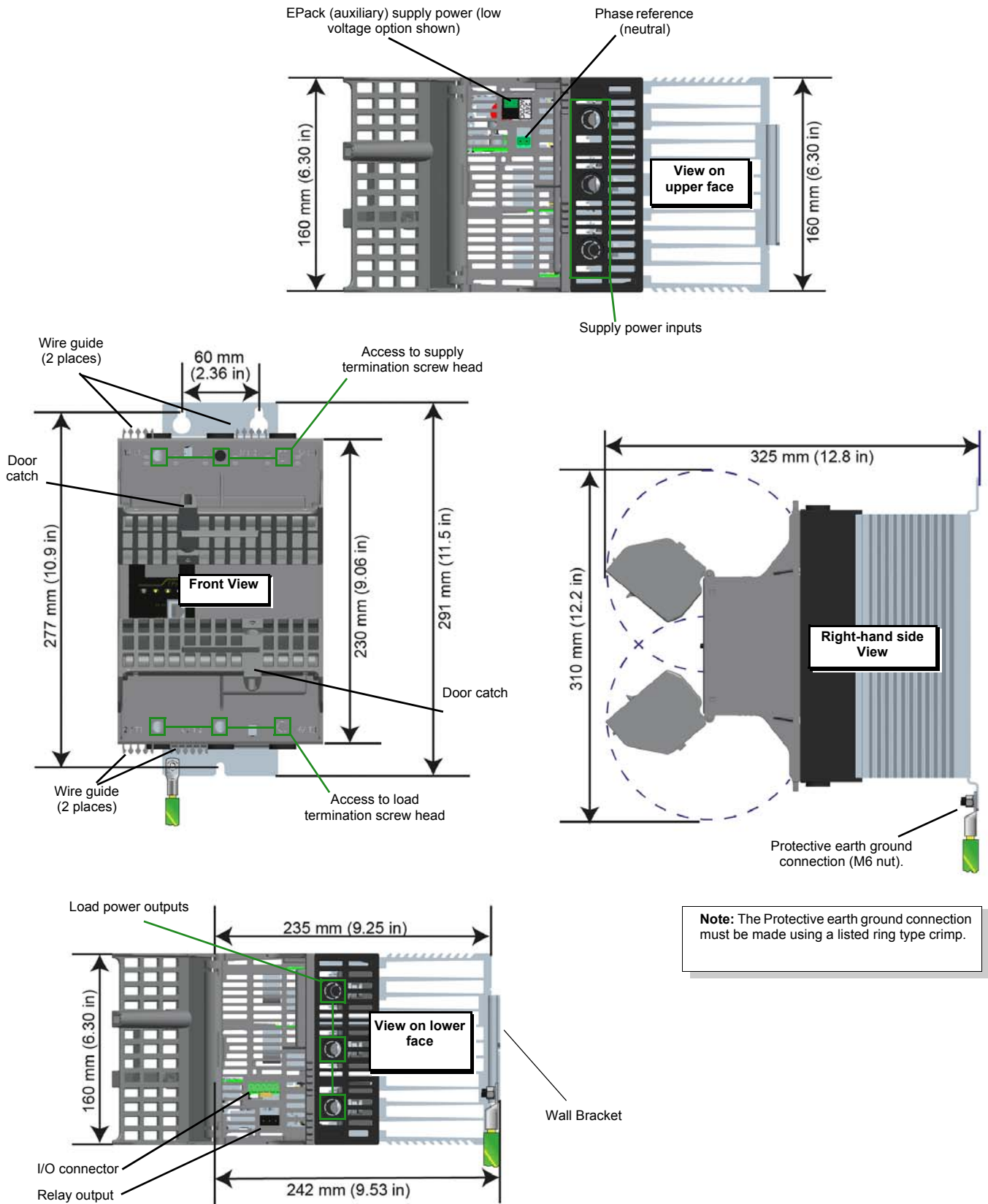

Figure 6: Mechanical installation details (80A to 100A units) (doors open).

125A unit dimensions

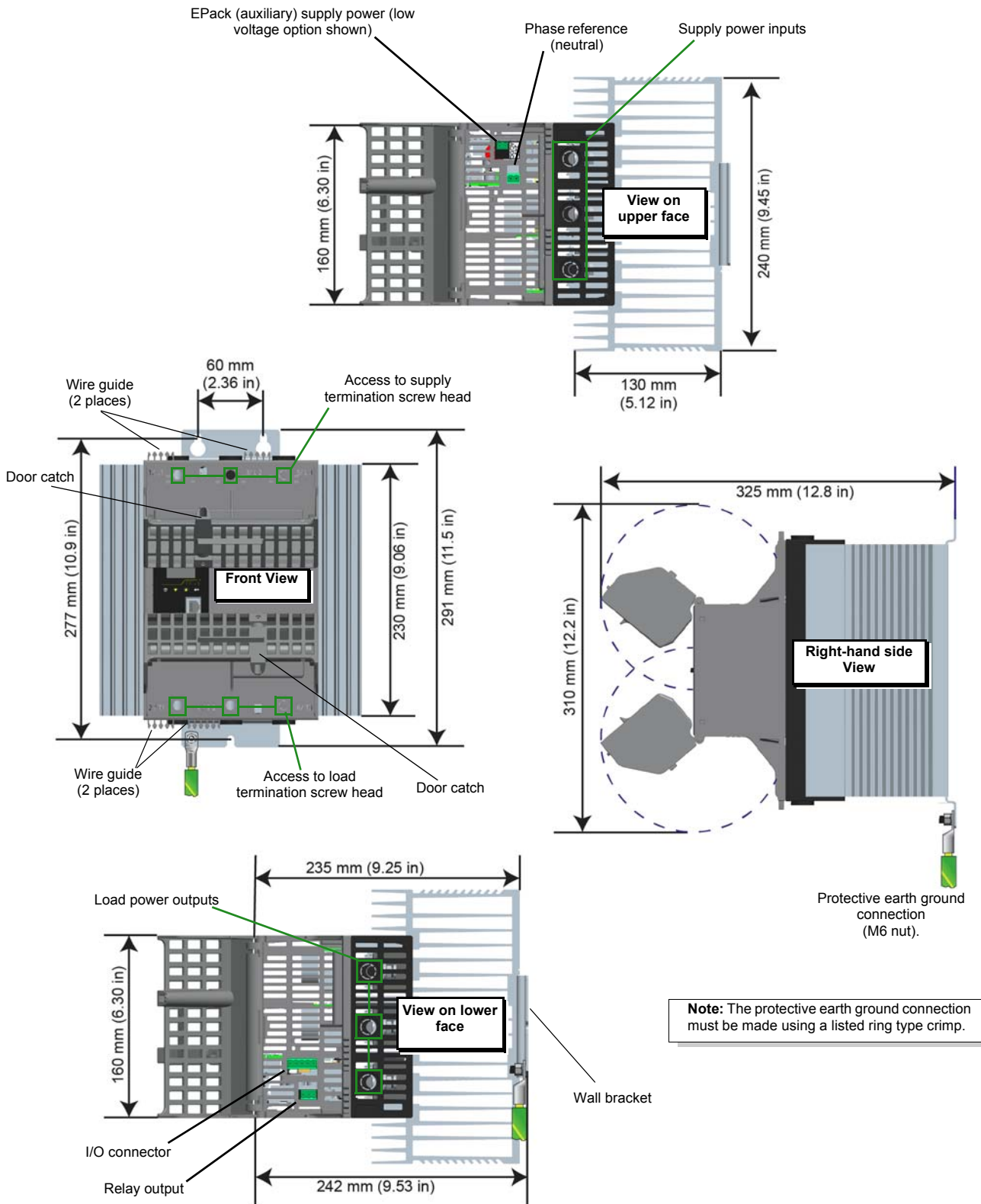



Figure 7: Mechanical installation details (125A units) (Doors open).

Summary - all units (16A - 125A)

Phase	2 phase			
Amps:	16 - 32A	40 - 63A	80 - 100A	125A
Dimensions mm(inches)				
Height	166 (6.535)	166 (6.535)	230 (9.055)	230 (9.055)
with Double DIN Rail	213.5 (8.405)	213.5 (8.405)	N/A ¹	N/A ¹
with Wall back plate	229.5 (9.035)	229.5 (9.035)	291 (11.456)	291 (11.456)
Doors open	290 (11.417)	290 (11.417)	310 (12.204)	310 (12.204)
Depth	185 (7.283)	220 (8.661)	235 (9.251)	235 (9.251)
with Wall back plate	192 (7.559)	227 (8.937)	242 (9.527)	242 (9.527)
with doors open	N/A ²	N/A ²	325 (12.795)	325 (12.795)
Width	117 (4.606)	117 (4.606)	160 (6.299)	240 (9.448)
with doors open	242 (9.527)	242 (9.527)	N/A ³	N/A ³
Wall mount Fixings				
Distance apart:				
Medium mount	219 (8.622)	219 (8.622)	-	-
Large mount	-	-	277 (10.905)	277 (10.905)
Double DIN Rails	125 ±3 (4.921 ±0.12)	125 ±3 (4.921 ±0.12)	-	-
Distance between top, two fixings:				
Large mount	-	-	60 (2.362)	60 (2.362)
HeatSink Depth	55 (2.165)	90 (3.543)	97 (3.818)	130 (5.118)

1. Not applicable, double DIN rail option not available.
2. Not applicable, doors open sideways increasing only the width.
3. Not applicable, doors open vertically (up or down) towards the centre of the product increasing only the depth.

Electrical Installation

 CAUTION
<p>Ensure effective strain relief mechanism (i.e. trunking) is in place for all EPack cables.</p> <p>If effective strain relief mechanism (i.e. trunking) is not installed it may result in the unintentional disconnection of one of more connectors resulting in unexpected and possible lack of control.</p> <p>Failure to follow these instructions can result in death, serious injury or equipment damage.</p>

Connection Details

Wire conductor cross sections must comply with table 9 of IEC60947-1 (or NEC, Article 310 Table 310-16).

Where a range of wire sizes is given it is up to the user to select the correct cross sectional area required for the application.

The protective earth ground cable should be, as a minimum, of the same cross sectional area as the cables used for the load (i.e. the cables terminated at the 1/L1 and 2/T1 terminals).

The protective earth ground must be made to the unit with a Listed ring type crimp terminal, using the nut and shakeproof washer supplied (M6 for 16A to 125A units).

Table 1 gives details of tightening torques for the various supply power and signal wiring connections.

 DANGER
<p>The protective earth ground connections and power terminals must be tightened according to the torque values defined in Table 1, "Connection Details," on page 29. Appropriate regular inspections must be performed.</p> <p>Failure to follow these instructions will result in death, serious injury or equipment damage.</p>

Terminals	Product Rating	Terminal Capacity		Wire Type	Torque	Comments	
		mm ²	AWG				
Supply voltage (1/L1, 3/L2) and Load supply (2/T1, 4/T2)	16A to 63A	1.5 mm ² to 25 mm ²	AWG 16 to AWG 4	Stranded copper Rated 90°C	2 N.m (18 Lb.inch.)	Flat-bladed screwdriver 1 x 5.5 mm or 1.2 x 6.5 mm	
	80A to 125A	10 mm ² to 50 mm ²	AWG 8 to AWG 2/0		5.6 N.m (50 Lb.inch.)	Flat-bladed screwdriver 1 x 5.5 mm or 1.2 x 6.5 mm	
Protective earth ground	16A to 63A	M6 ring-type crimp terminal			2.5 N.m (22 Lb.inch.)	U.L.: Listed ring-type crimp terminal must be used	
	80A to 125A	M6 ring-type crimp terminal			5.6 N.m (50 Lb.inch.)	U.L.: Listed ring-type crimp terminal must be used	
Reference (Vref) (2-way) Supply (24V ac/dc) (2-way) Supply (85V-550Vac)(3-way) I/O connector (5-way) Relay connector (3-way)	All	0.25 mm ² to 2.5 mm ²	AWG 24 to AWG 12		Stranded copper Rated 75°C	0.56 N.m (5 Lb.inch.)	Flat-bladed screwdriver 0.6 x 3.5 mm

Table 1: Connection Details

**DANGER**

Connection of 2 conductors in the same terminal is not allowed.

Failure to follow these instructions will result in death, serious injury or equipment damage.

Auxiliary supply

The auxiliary supply connections (to operate the EPack unit) are terminated using a 2-way (24V ac/dc version) or 3-way (85 to 550Vac version) connector, located on the upper side of the unit, as shown in [Figure 8](#) and [Figure 9](#).

24V ac/dc auxiliary supply

 DANGER
<p>The cable used to connect auxiliary supply should be correctly protected by a branch-circuit protection. It is the responsibility of the user to add branch-circuit protection. Such branch-circuit must comply with applicable local regulations.</p> <p>Auxiliary supply 24V ac/dc:</p> <p>To comply with safety requirements, the 24V auxiliary supply must be derived from a SELV or PELV circuit.</p> <p>Failure to follow these instructions will result in death, serious injury or equipment damage.</p>

85 to 550Vac auxiliary supply

 DANGER
<p>The maximum voltage between any pole of the power supply and terminals 1/L1, 3/L2 and Vref shall be lower than 550Vac. The maximum voltage between any pole of the power supply and protective earth ground shall be lower than 550Vac (rated insulation voltage 500V).</p> <p>The 85Vac to 550Vac auxiliary supply shall be protected by a supplemental fuse or by branch circuit fuses as listed in Table 2, "Auxiliary supply, fuse protection," on page 31.</p> <p>Failure to follow these instructions will result in death, serious injury or equipment damage.</p>

 DANGER
<p>If the supplemental fuse is chosen to protect the 85Vac to 550Vac auxiliary supply, the cable used to connect auxiliary supply should be correctly protected by a branch-circuit protection.</p> <p>It is the responsibility of the installer to add branch-circuit protection. Such branch-circuit protection must comply with applicable local regulations.</p> <p>Failure to follow these instructions will result in death, serious injury or equipment damage.</p>

Auxillary supply fuse protection

UL Fuse Category	CE Fuse Category	Fuse (Make and Type)
Supplemental	Supplemental	ATM2-type fuse rated 2A, 600Vac/dc: Mersen/Ferraz Shawmut (UL file: E33925)
Branch Circuit	Supplemental	J-type fuse rated 3A/600Vac: HSJ3 by Mersen/Ferraz Shawmut (UL file: E2137; CSA class: 1422-02 LR12636) or DFJ-3 by Eaton/Cooper Bussman (UL file: E4273; CSA class: 1422-02 LR53787)
Supplemental	Branch Circuit	gR-type fuses rated 3A /700V: FR10GR69V3 (V1014571) by Mersen/Ferraz Shawmut (UL file: E76491)

Table 2: Auxillary supply, fuse protection

Connections (Supply Power and Load)

16A to 32A and 40A to 63A Units

The supply voltage is connected to terminals on the top of the the unit (1/L1 and 3/L2). The load terminals are located on the lower side of the unit (2/T1 and 4/T2). [Figure 8](#) shows the 32 Amp unit (63 Amp unit similar) and [Figure 9](#) gives similar information for the 80/100 Amp unit (125Amp units similar).

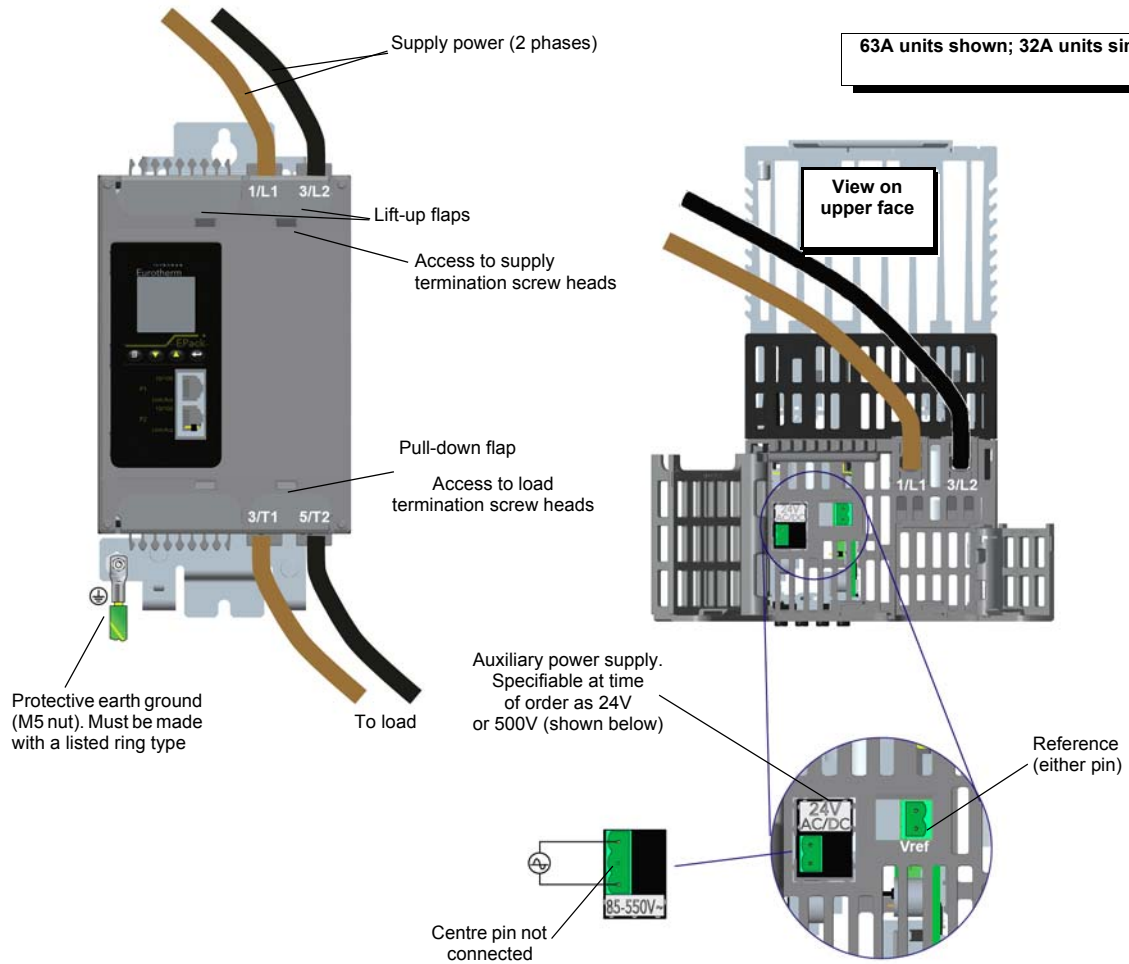

Figure 8: Supply power connection details (32A and 63A units)

80A, 100A and 125A units

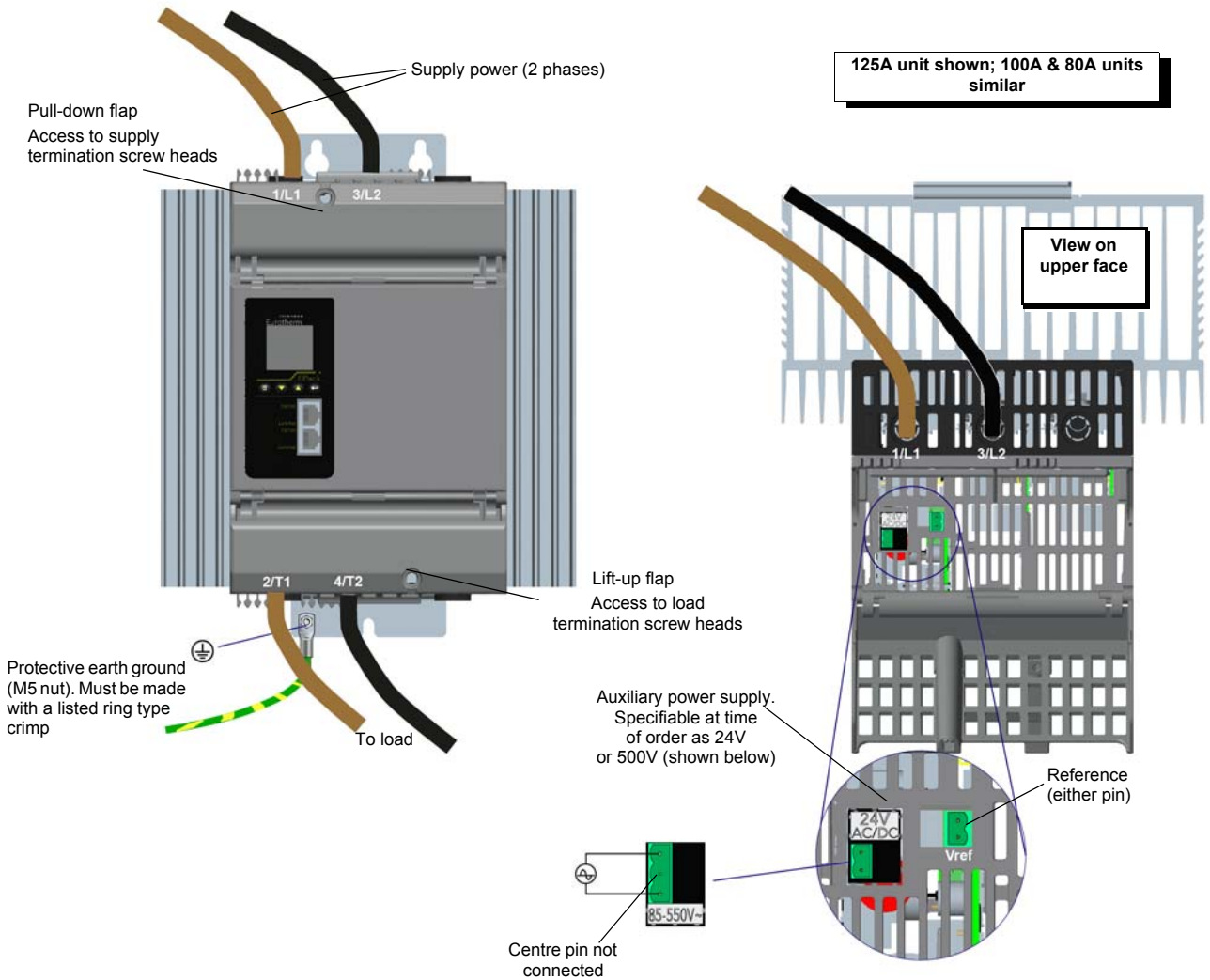

Figure 9: Supply power and Load connection details .

NOTE: See figure 8 for basic wiring details.

⚠ **WARNING**

IP20 Protection

1. In order to maintain IP20 protection, the stripped length of the power cables (1/L1 and 2/T1) must be adapted according to the insulation thickness.
2. If the upper and/or lower access door is open, the product protection is IP10.
3. If the Vref connector is removed, IP20 rating is not guaranteed.
4. Breakaway features have been designed into the product especially to improve the IP20 rating. These features should only be removed for cables with a diameter 9mm² or larger.
5. If the exposed conductor is less than 20 mm there is a potential risk of a loose connection.
6. If the exposed conductor is greater than 23 mm, IP20 is not guaranteed and the product is instead IP10.

Failure to follow these instructions can result in death, serious injury or equipment damage.

EPack rating (Amps)	Exposed conductor length mm (inch)	Cable breakway access required mm (inch)	Cable Diameter maximum mm (inch)
16A to 63A	20 - 23 (0.79 - 0.91)	9 (0.35)	10.5 (0.41)
80A to 125A	20 - 23 (0.79 - 0.91)	9 (0.35)	17.5 (0.69)

Table 3: Cable connection specification

Load Configurations

Delta

Closed Delta

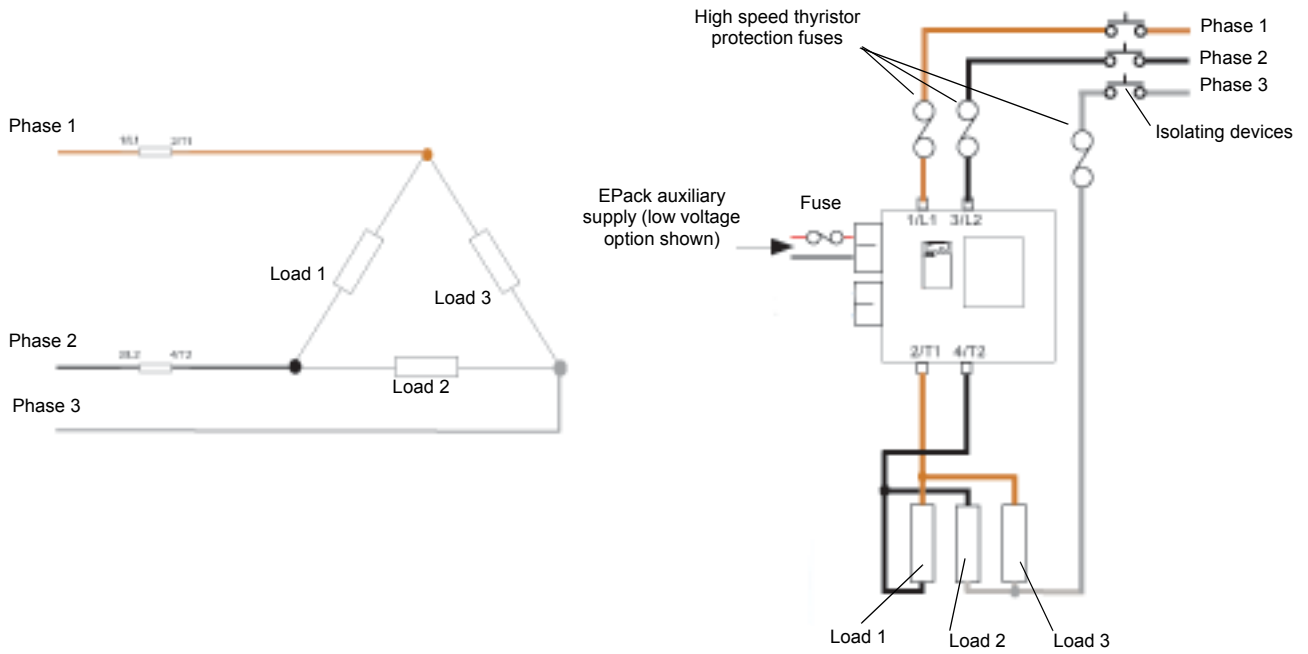

Figure 10: 2 phase Closed Delta wiring scheme/load configuration

Star

Star without Neutral

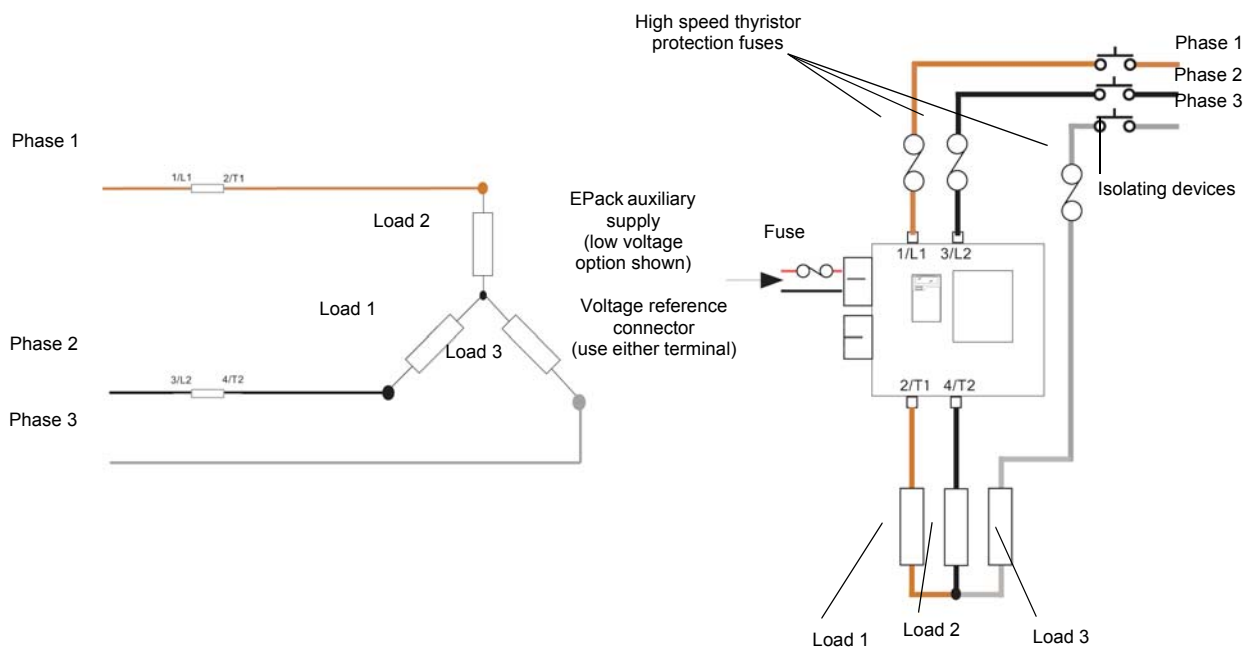

Figure 11: 2 phase Star without neutral wiring scheme/load configuration

Signal wiring

Figure 12 shows the connector location, on the underside of the unit, for the digital and analogue inputs, and for the internal relay output.

Enable Input

In order for the power module thyristors to operate, the Enable input must be valid, in the default configuration, this is achieved by shorting pins 0V and DI1 of the I/O connector located on the underside of the unit (Digital input 1), or by using a User Value block to apply a logic high to the enable input to the relevant firing block in iTools.

If required, DI1 can be configured as a voltage input, and in this case it requires a high signal to be applied to D1 with the relevant zero voltage connected to 0V.

Alarm Acknowledge

In the default configuration, shorting pins 0V and DI2 of the I/O connector located on the underside of the unit (Digital input 2) acknowledges alarms. As an alternative, a logic input can be wired to the relevant parameter using iTools.

DI2 can be configured as a voltage input (if required), and in this case it requires a high signal to be applied to D2 with the relevant zero voltage connected to 0V.

Main Setpoint

In the default configuration, the analogue input sets the main setpoint.

Relay Output

The relay is normally energised (Common and Normally Open pins shorted), and is de-energised (Common and Normally Closed pins shorted) when active. In the default configuration, the relay output is operated by the Fault detect 'Custom Alarm' ([Fault Detection Menu](#)) becoming active.

By default, the Custom alarm is set up to be equivalent to 'AnySystemAlarm' which becomes active if any 'stop firing' error, such as those listed below, is detected.

If the Graphical Wiring Editor is available, iTools can be used to reconfigure the relay such that it operates under the control of any suitable parameter. (iTools must be in Configuration mode).

In configuration mode, it is also possible to configure the relay using the 'AlmRly' tab in any function block (e.g. analogue input) which includes alarm functions, or from the Alarm Relay menu in the Operator Interface ([page 101](#)).

1. Missing mains. Supply voltage line is missing.
2. Thyristor short circuit¹
3. Network dips. A reduction in supply voltage exceeding a configurable value (VdipsThreshold), causes firing to be inhibited until the supply voltage returns to a suitable value. VdipsThreshold represents a percentage change in supply voltage between successive half cycles, and can be defined by the user in the Network.Setup menu.
4. Freq Fault. The supply frequency is checked every half cycle, and if the percentage change between successive 1/2 cycles exceeds a threshold value (max. 5%), a Mains Frequency System Alarm is generated. The threshold value (FreqDriftThold) is defined in the Network.Setup menu.
5. Supply failure to EPack unit.
6. Chop Off ([page 51](#))
7. Analogue input over current. For mA inputs this alarm is active if there is too high a current flowing through the shunt.
8. Line under voltage (configurable between 2 and 30% of nominal voltage).
9. Line over voltage (configurable between 2 and 10% of nominal voltage).
10. Over current (configurable between 10 and 400% of nominal current).

The relay is de-energised temporarily then re-energised at start-up.

1. It's not possible to detect a thyristor short circuit when the unit is delivering 100% output power.

I/O Input & Output Details

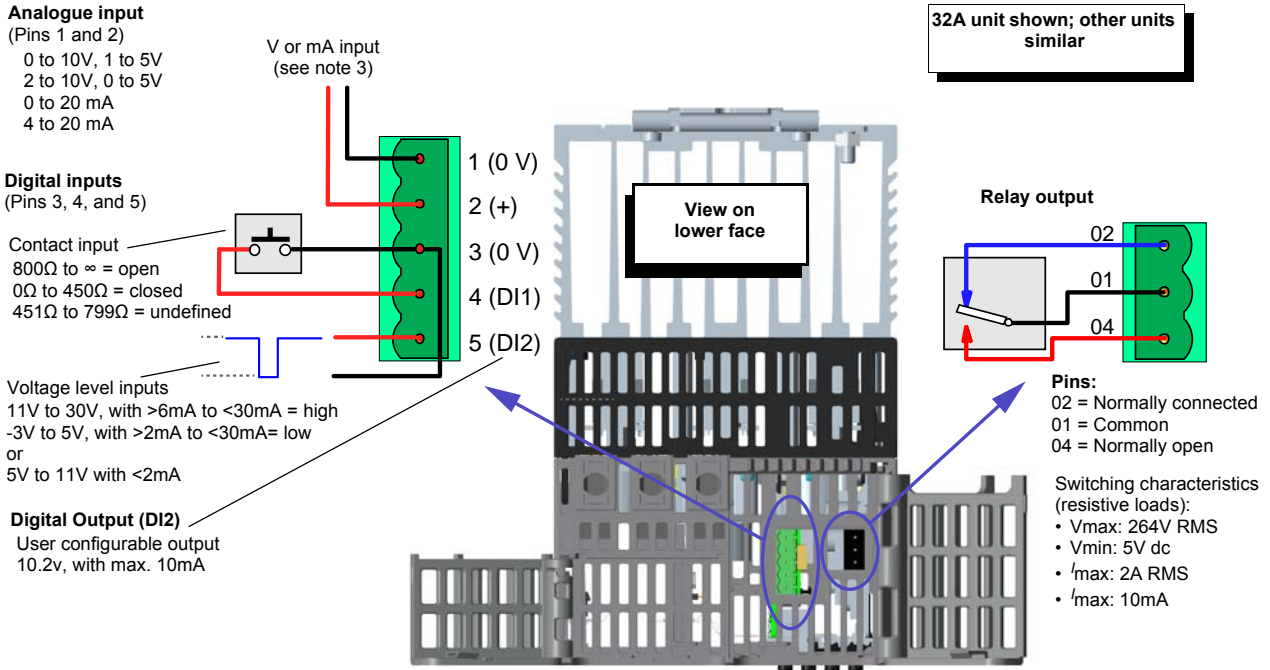

Figure 12: I/O details

NOTES:

1. DI1 shown; DI2 similar
2. DI1 and DI2 can both be contact inputs or both be voltage inputs or be one of each.
3. Analogue input type (Volts or mA) is selected in I/O Analogue IP configuration. When a mA range is selected, a suitable shunt resistor is automatically connected into circuit. It is thus unnecessary for the user to fit external components.
4. Diagram shows DI1 as a contact input and DI2 as a voltage level input, however DI2 can also be configured as a 10.2V, with max. 10mA output, providing it is not being used as a digital input.

Network Communications

Ethernet Wiring

An ethernet networking capability is provided by a pair of RJ45 connectors, located at the front of the EPack power controller unit.

Communications Pinouts

Each connector has a pair of LED indicators to indicate network connection (amber LED) and network Tx activity (flashing green).

The connection is 10/100 base T, autosensing.

Pin	Signal
8	Not used
7	Not used
6	Rx-
5	Not used
4	Not used
3	Rx+
2	Tx-
1	Tx+

LEDs:
Green = Tx activity
Yellow = Connected

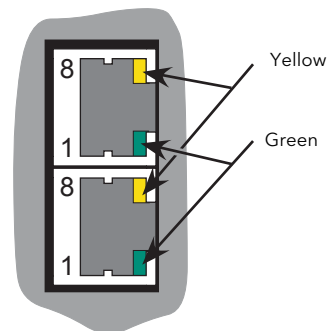

Figure 13: EPack Pinouts

Operator Interface

Located at the front of the Driver Module, the operator interface consists of a 26mm square display, and, four push-button switches.

Display

The display is divided vertically into three areas, which for the purposes of this manual are called the status area at the top, the data display, in the centre, and the soft keys at the bottom. This display, together with the four pushbuttons allows full operation and configuration of the unit.

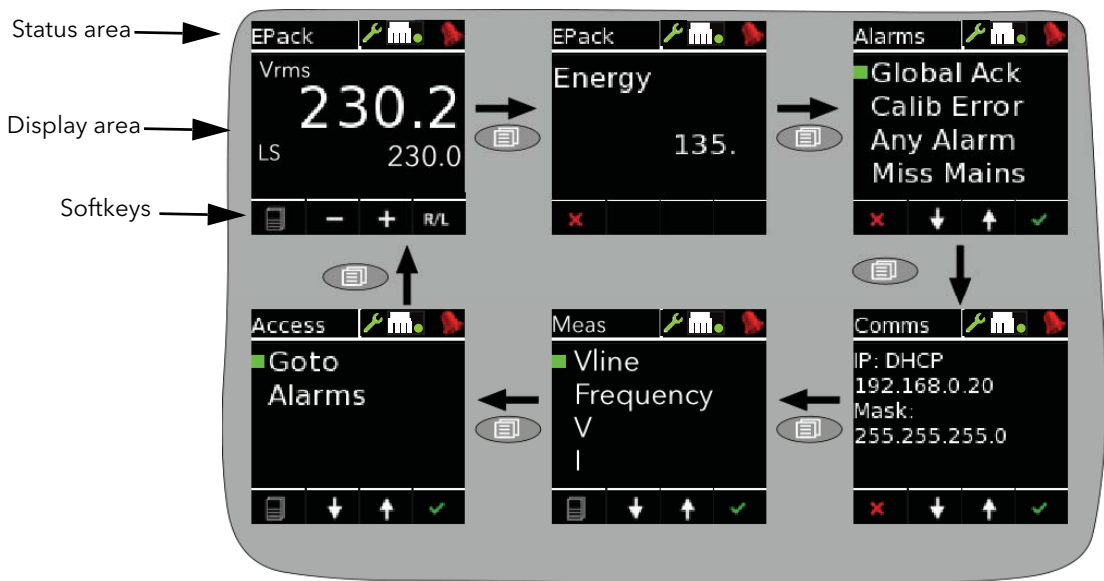

Figure 14 Operator interface



The figure above shows a typical operator mode screen set, scrolled through using the return (page) pushbutton. The configuration of the unit defines which parameters actually appear.

NOTES:

1. The Energy display appears only if the Energy option is fitted
2. The Alarms display appears only if there are any active alarms. The up/down arrow pushbuttons can be used to scroll through the alarm list, if there are more alarms active than can be displayed on one screen height.
3. The 'Goto' item allows the user to enter Engineer or Configuration mode, providing the password(s) are known. [Access menu \(page 103\)](#) describes the procedure (although the screen displays are different because in that section, the unit is shown in configuration mode).







Status area

This area at the top of the screen contains text descriptive of the current operation, and a number of icons as follows

-  Configuration key. Displayed when the unit is in configuration mode.
-  Ethernet connection key. If upper connector on the front panel has an active network connection, then the upper of the two green dots is illuminated. If the lower connector has an active ethernet connection, then the lower spot is illuminated.
-  Alarm symbol. Indicates that one of more alarms is active.

Softkey icons

A number of icons can appear at the bottom of the display, and each icon represents the action of the pushbutton immediately below it.

-  Menu. This appears in the bottom left corner, and operation of the Return pushbutton causes the top level menu to appear.
-  Return. This red cross icon appears in the bottom left corner, and operation of the Return pushbutton causes any configuration changes on the current page to be 'undone' or, if none, causes the display to 'go up' one level.
-  Plus and minus icons. Operation of the associated scroll up/down pushbutton causes the displayed value to increment or decrement
-  Up/down arrows. Operation of the associated scroll up/down pushbutton causes the various menu items on display to be scrolled through.
-  Right/Left arrow. The right-pointing arrow appears in the bottom right-hand corner, and operation of the Enter pushbutton causes the cursor to shift right. Once this has been done, a left-pointing arrow appears in the bottom left-hand corner, allowing the user to shift the cursor to the left using the Return pushbutton.
-  Enter. This green tick appears in the bottom right corner, and operation of the Enter pushbutton causes any configuration change(s) on the display page to be confirmed.
-  Remote/Local. This appears in the bottom right corner, and operation of the Enter pushbutton toggles the setpoint selection between local and remote.

Pushbuttons

The functions of the four pushbuttons below the display depend on what is displayed in the softkey area. The leftmost pushbutton (Return) is associated with the leftmost soft key, the down arrow pushbutton is associated with the next soft key and so on. In the example above, the 'Return' key is used both to enter the Menu, and to return from it to the initial display.

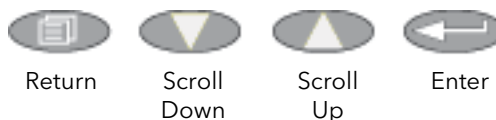

Pushbutton functions

Return	Returns to previous menu (while menus are displayed), cancels editing (during parameter editing), and performs screen cycling (during operator mode).
Scroll down/up	Allows the user to scroll through the available menu items or values.
Enter	Goes to next menu item. In parameter edit mode, this button confirms the changes.

Menu item value selection

Menu items are scrolled through using the up/down pushbuttons. Once the required item is displayed, the Enter pushbutton is used to select it for editing. Editing of the item's value is carried out by scrolling through the available choices, using the up and down scroll keys. Once the desired value is displayed, the Enter pushbutton is used to confirm the choice.

Where multiple changes have to be made (as in editing an IP address for example), the Enter pushbutton acts as a right cursor key, moving from the field just edited to the next field. (The Return key moves the cursor left). Once all fields have been edited, the enter key is used a final time to confirm the choice.

Front Panel Event Indication

A number of instrument alarms and events can occur, and these are indicated by icons appearing on the display screen. The events and alarms are listed below. See for a more details.

Instrument events

Conf Entry	The instrument has been placed in configuration mode (cog-wheel symbol).
Conf Exit	The instrument has been taken out of configuration mode (no icon).
GlobalAck	A global acknowledgement of all safe latched alarms has been performed.
Quick Code Entry	The Quick Code menu is active (cogwheel icon + 'QCode' in display area).

The following alarms all cause a red bell icon to appear in the top right hand corner of the screen.

Indication alarms

LimitAct	One or more limits are active in the control block
LoadOverl	An over current alarm has become active in one or more Network blocks.
PrcValTfr	Process value transfer is active in the control block.

System alarms

ChopOff	The 'Chop-off' alarm has been detected.
FuseBlown	There is no internal fuse, but it is possible to use DI2as a 'fuse-blown' input wired to the alarm block in iTools.
MainsFreq	Mains Frequency is outside the acceptable range.
Missmains	Supply power is missing.
NetwDip	The 'network dip' alarm has been detected.
Thyr SC	Thyristor short circuit. It is not possible to detect a thyristor short circuit when the unit is delivering 100% output power.

Process alarms

ClosedLp	The Control block 'Closed Loop' alarm has been detected.
Ana_In Over C	Over current in shunt. If this alarm is detected, firing is stopped by default and Analogue Input type is automatically switched to 0-10V mode to avoid damage.
Under Volt	Line under voltage (configurable between 2 and 35% of nominal voltage).
Over Volt	Line over voltage (configurable between 2 and 10% of nominal voltage)
PLF	The 'Partial Load Failure' alarm has been detected.
TLF	The 'Total Load failure' alarm has been detected.
PLU	The 'Partial Load Unbalance' alarm has been detected.

Quickcode

At first switch-on, the E-Pack unit enters the 'QuickCode' menu which allows the user to configure the major parameters without having to enter the full configuration menu structure of the unit. Figure 15 shows an overview of a typical QuickCode menu. The actual displayed menu items will vary according to the number of software features purchased. When 'Finish' is selected to 'Yes', the instrument cold starts after confirmation (Enter key); when set to 'Cancel' the instrument discards any changes and restarts with the previous configuration.

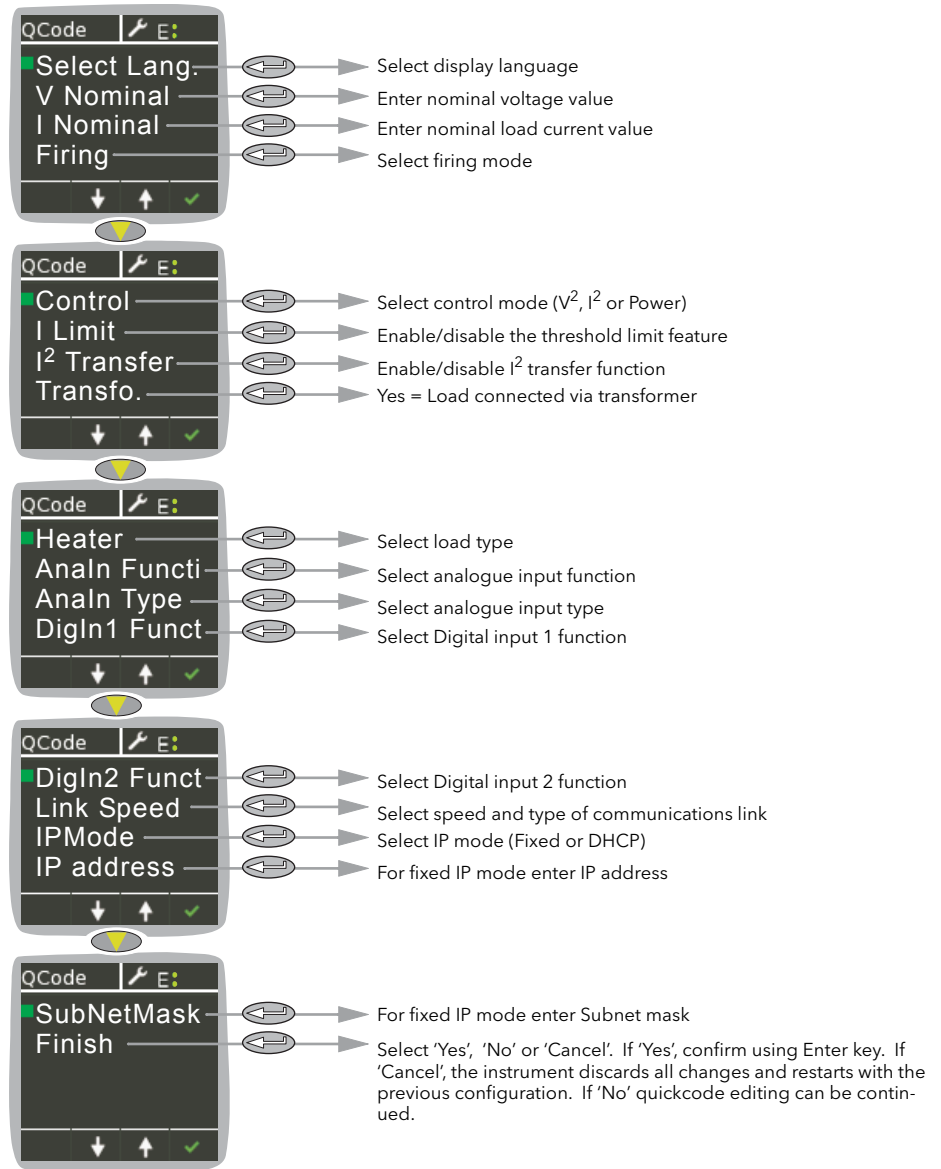

Figure 15 Typical QuickCode menu

NOTES:

1. If the unit has been fully configured at the factory, the Quickcode menu will be skipped, and the unit will go into operation mode at first switch on.
2. Once quit, the Quickcode menu can be returned to at any time from the Access menu (described later in this document ([Configuration using iTools \(page 106\)](#))). Returning to the Quickcode menu cold-starts the unit

Quickcode Menu Parameters

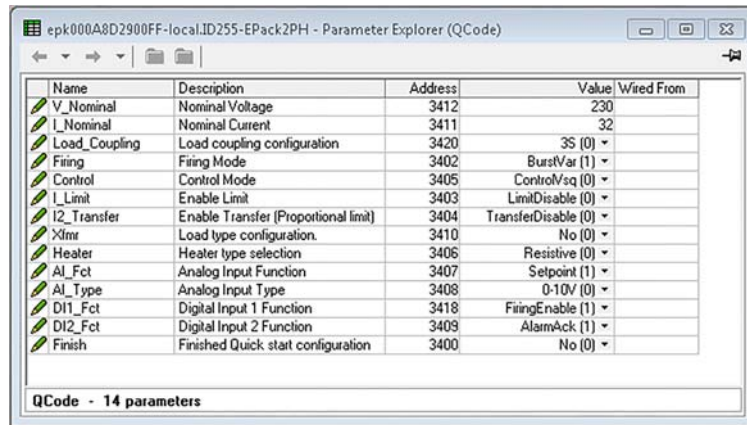

Figure 16 iTools Qcode page

- Language Select English, French, German, Italian or Spanish. Once confirmed all further displays appear in the selected language.
- V Nominal The nominal value of the supply voltage (valid entries are 20V to 500V). Default value appears. Use the up/down arrow buttons to edit.
NOTE: Using Star with neutral configuration the nominal voltage is line to neutral, for all others configurations it is line to line.
- Nominal The current flowing through the load according to the nominal load power. This current must not exceed the maximum current the unit can safely sustain. Lower values are not recommended as in such cases, the resulting accuracy and linearity are not guaranteed to be within specification. Default value appears. Use up/down arrow buttons to edit.
- Firing Mode Select from IHC (Intelligent Half Cycle), Burst Var (Burst Variable), Burst Fix (Burst Fixed), Logic or Phase Angle.
- Control Select VSq (V²), Isq (I²) or Power
- ILimit Used to enable/disable threshold limit. (By default the current limit function is enabled).
- I²Transfer This is used to enable/disable the transfer feature. Quick code configures squared current as the transfer process value.
- XFRMR (Transfo.) No = Resistive load type; Yes = Transformer primary.
- Heater Select from Resistive, (Short wave) Infra red, CSi (Silicon carbide) or MOSi2 (Molybdenum disilicide)
- Analn Functi Select SP (setpoint), HR (setpoint limit), CL (current limit), TS (transfer limit) or None (no function) as Analogue Input function
NOTE: Setpoint is only available for Analn Functi if DI2 Fct is not set to 'Setpoint' while Firing Mode is set to 'Logic'.
- Analn Type Select 0 to 10V, 1 to 5V, 2 to 10V, 0 to 5V, 0 to 20mA or 4 to 20 mA as analogue input type.
- DI1 Fct Select 'Firing Enable' or 'None'.
- DI2 Fct Alarm ack(nowledge), RemSP sel (select remote setpoint), Fuse Blown, 10V user input or none.
NOTE: Setpoint is only available for Analn Functi if DI2 Fct is not set to 'Setpoint' while Firing Mode is set to 'Logic'.
- Link Speed Select from 'AutoNego', 100Mb, 100 Mb Half duplex, 10 Mb, 10Mb Half duplex.
- IP Mode Choose 'Fixed', 'DHCP' or 'DCP' (if Profinet feature enabled).
- IP Address For fixed mode, allows the IP address to be edited, one section at a time. Use the up-down arrow pushbuttons to edit the first

section (XXX.xxx.xxx.xxx), then 'Enter' to move to the next section (xxx.XXX.xxx.xxx) and repeat until all four sections are as required

SubNetMask
Finish

As for IP address above, but for the subnet mask.
If 'Yes' is selected (and confirmed using the enter key), quick code exits and the instrument restarts with the new configuration. If 'No' is selected then no action is taken and the user can continue to edit the quick code parameters. If 'cancel' is selected then all changes are discarded, quick code exits and the instrument restarts with the previous (i.e. unedited) configuration.

Firing modes definitions

Logic

Power switches on, two or three zero crossings of the supply voltage after the logic input switches on. Power switches off two zero crossings of current after the logic input switches off. For resistive loads, voltage and current cross zero simultaneously. With inductive loads, a phase difference exists between the voltage and current, meaning that they cross zero at different times. The size of the phase difference increases with increasing inductance.

Power on-off delay = two or three mains zero crossings depending on where in the mains cycle the logic output changes state.

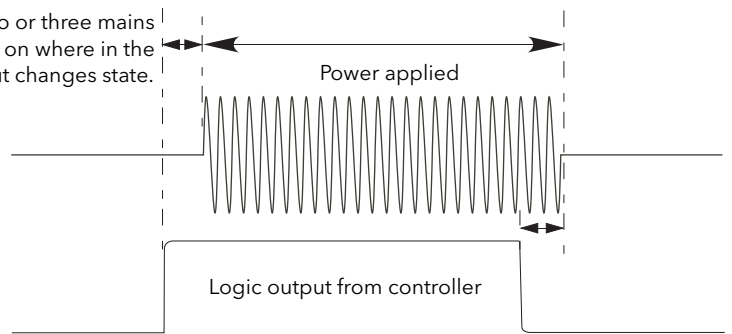

Figure 17 Logic firing mode

Burst Fixed Firing

This means that there is a fixed 'cycle time' equal to an integer number of supply voltage cycles as set up in the Modulator menu. Power is controlled by varying the ratio between the on period and the off period within this cycle time (figure 18).

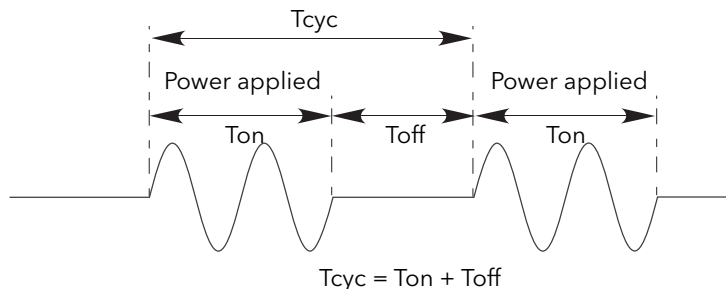

Figure 18 Burst Fixed mode

Burst Variable Firing

Burst Firing Variable is the preferred mode for temperature control. Between 0 and 50% of setpoint, the on time is the 'Min on' time set in the modulator menu and the off time is varied to achieve control. Between 50% and 100%, the off time is the value set for 'Min on' and power is controlled by varying the number of on cycles.

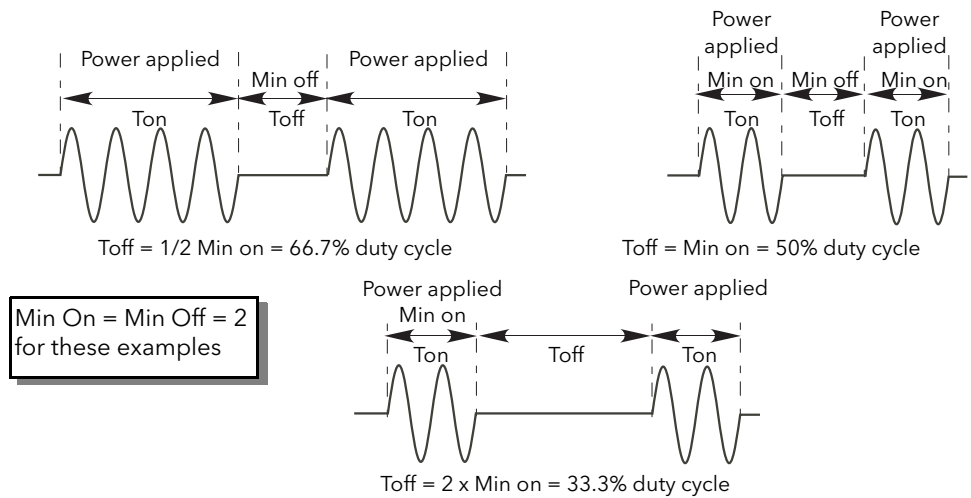

Figure 19 Burst variable firing

Phase Angle Control

This mode of firing controls power by varying the amount of each cycle which is applied to the load, by switching the controlling thyristor on part-way through the cycle. Figure 20 shows an example for 50% power.

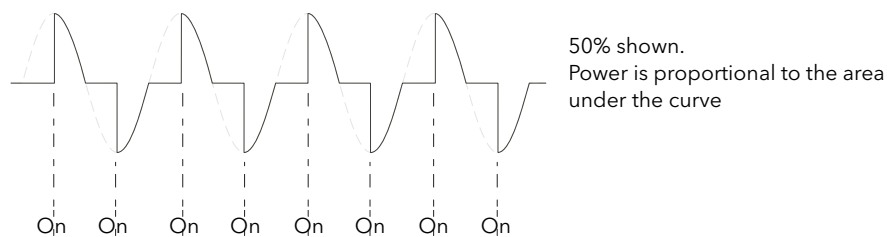

Figure 20 Phase angle mode

Intelligent (IHC) Mode

Burst mode firing with a single firing (or non-firing) cycle is known as 'Single cycle' mode. In order to reduce power fluctuations during firing time, Intelligent half-cycle mode uses half cycles as firing/non-firing periods. Positive and negative going cycles are evened out, to ensure that no dc component arises. The following examples describe half-cycle mode for 50%, 33% and 66% duty cycles.

50% Duty Cycle

The firing and non-firing time corresponds to a single supply cycle (figure 21).

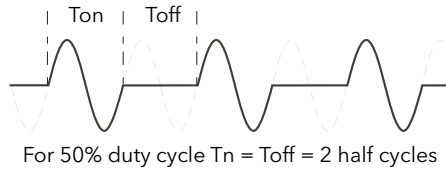

Figure 21 Intelligent half cycle mode: 50% duty cycle

33% Duty Cycle

For duty cycles less than 50%, the firing time is one half-cycle. For a 33% duty cycle, firing time is one half cycle; the non-firing time is two half-cycles (figure 22).

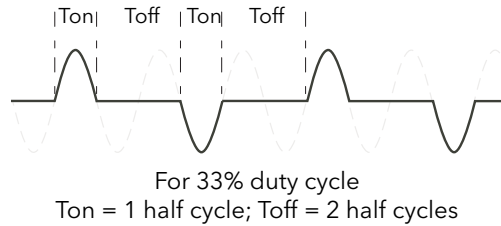

Figure 22 Intelligent half cycle mode: 33% duty cycle

66% Duty Cycle

For duty cycles of greater than 50%, the non-firing time is one half-cycle. For 66% duty cycle, the firing time is two half cycles; the non-firing time is one half cycle (figure 23).

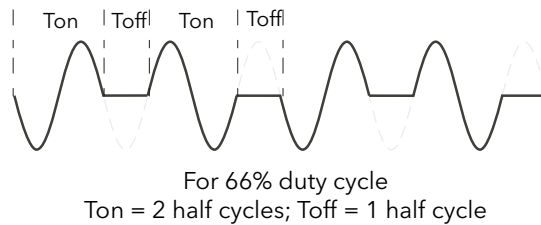

Figure 23 Intelligent half cycle mode: 66% duty cycle

Feedback type

All feedback types (except 'Open Loop') are based on real-time measurement of electrical parameters that are normalised to their equivalent Nominal values.

V^2	Feedback is directly proportional to the square of the RMS voltage measured across the load. For two- or three-phase systems, feedback is proportional to the average of the squares of the individual phase-to-phase or phase-to-Neutral RMS voltage across each load.
Power	Feedback is directly proportional to the total true power delivered to the load network.
I^2	Feedback is directly proportional to the square of the RMS current through the load. For two- or three-phase systems, feedback is proportional to the average of the squares of the individual RMS load currents.
Open loop	No measurement feedback. The thyristor firing angle in Phase angle mode, or the duty cycle in burst-firing mode, are proportional to the setpoint.

Transfer Mode

The control system can use automatic transfer of certain feedback parameters. For example with loads with very low cold resistance, I^2 feedback should be used to limit inrush current, but once the load has started to warm up, Power feedback should be used; the control program can be configured to change feedback mode automatically.

The Transfer mode can be selected as I^2 to P or I_{rms} to P as appropriate to the type of load being controlled.

None	No feedback parameter transfer to the control program.
I^2	Selects transfer mode: I^2 to the selected Feedback Mode (above).

Limitation features

In order, for example, to prevent potentially damaging inrush currents, it is possible to set a value for power or Current squared which is not to be exceeded. For loads exhibiting a low impedance at low temperatures but a higher impedance at working temperature, the current drawn reduces as the load warms, and limiting gradually becomes unnecessary.

[Control limit configuration \(page 116\)](#) describes the configuration parameters which allow the user to enter a Process Variable (PV) and a setpoint (SP), where the PV is the value to be limited (e.g. I^2) and the SP is the value that the PV must not exceed.

Firing Angle Limiting

For phase angle control, limiting is achieved by reducing the firing angle on each half mains cycle such that the limit value of the relevant parameter is not exceeded. As limiting is reduced so the phase angle tends to its target value.

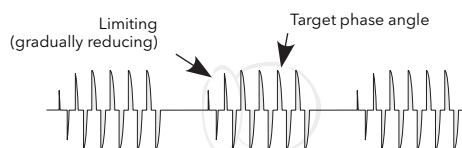

Duty Cycle Limiting

For Burst Firing only, limiting reduces the 'On' state of the burst firing driving the load. Load current, voltage and active power are calculated over the period of each (Ton + Toff) period.



WARNING

When applied to load current, duty cycle limiting does not limit the peak current value, and under some circumstances this may allow an overheating hazard in the load and/or Power Module to develop.

Failure to follow these instructions can result in death, serious injury or equipment damage.

Chop Off

This is a limiting technique which detects an over-current alarm state and stops further thyristor firing for the duration of that alarm state. All the relevant parameters are to be found in the Network Setup menu ().

There are two alarms which may trigger Chop Off, as follows:

1. The chop-off alarm becomes active when a current threshold is exceeded for more than a pre-defined number of mains period. This current threshold is user- adjustable from 100% to 400% of unit's nominal current (INominal).
2. The alarm is active if ChopOff2Threshold is exceeded more than a specified number of times (Number Chop Off) within a specified time period (Window Chop Off). ChopOff2Threshold is adjustable between 100% and 350% inclusive, of Inominal; Number Chop Off can be selected to any value between 1 and 16 inclusive; Window Chop Off can be set to any value between 1 and 65535 seconds (approximately 18 hours 12 mins.). Each time the threshold is exceeded, the unit stops firing, raises a chop off condition alarm, then after 100ms, restarts using an up-going safety ramp. The condition alarm is cleared if the unit successfully restarts. If the alarm is raised more than the specified number of times within the specified window, then the Chop Off alarm is set and the unit stops firing. Firing is not resumed until the operator acknowledges the Chop Off alarm.

Communications

Ethernet/IP

Introduction

EPack EtherNet/IP (Ethernet/Industrial Protocol) is a 'producer-consumer' communication system used to allow industrial devices to exchange time-critical data. Such devices range from simple I/O devices such as sensors/actuators, to complex control devices such as robots and PLCs. The producer-consumer model allows the exchange of information between a single sending device (producer) and a large number of receiving devices (consumers) without having to send data multiple times to multiple destinations.

EtherNet/IP makes use of the CIP (Control & Information Protocol), common network, transport and application layers currently implemented by DeviceNet and ControlNet. Standard Ethernet and TCP/IP technology is used to transport CIP communications packets. The result is a common, open application layer on top of Ethernet and TCP/IP protocols. The EPack power controller can be directly included in an EtherNet/IP configured installation, with the EtherNet/IP option enabled, (a chargeable feature), see [Network Communications \(page 39\)](#).

EPack Power Controller, in common with other Eurotherm controllers, has available a large number of potential parameters but practical systems are constrained by the total I/O space available in the master being used and by the amount of traffic permissible on the network. A limited number of pre defined parameters have, therefore, been made available in EPack controller but it is possible to add non defined parameters as required by a particular process. This is described in [Data Exchange Mapping \(page 56\)](#).

Specific hardware must be used for the master such as an Allen-Bradley PLC.

NOTICE

The Ethernet/IP protocol and the PROFINET protocol cannot be used together, select the appropriate Protocol from the available options, see [Software upgrade \(page 199\)](#)..

EPack Power Controller EtherNet/IP Features

The EtherNet/IP implementation features in EPack power controller include:

- 10/100Mbit, full / half duplex operation: auto sensing
- Galvanically isolated bus electronics
- A selectable software option, at configuration
- Implicit (Polled) I/O messaging connection

CIP Object Support

Class (hex)	Name
01	Identity Object
02	Message Router Object
04	Assembly Object (32 inputs / 16 outputs <=> EPack's Fieldbus I/O Gateway)
06	Connection Manager Object
0F	Parameter Object (Optional)
F5	TCP/IP Interface Object
F6	Ethernet Link Object (Optional)

Setting Up the EPack Power Controller Unit

It is recommended that the communications settings for each instrument are set up before connecting it to any EtherNet/IP network. This is not essential but network conflicts may occur if the default settings interfere with equipment already on the network.

For the EtherNet/IP instrument the IP address, subnet mask, default gateway and DHCP enable need to be configured.

Changing any one of these parameters may immediately move the instrument to a new state. For this reason, it is recommended that such changes are made offline, before connecting to an Ethernet/IP network.

IP Addresses are usually presented in the form "abc.def.ghi.jkl". In the EPack Comms folder IP is represented using this standard, see below;

Pr	Nom	Description	Adresse	Valeur	Connexion de
🔧	Hostname	Name of the device on the link-local network.	3136	epk000A8D390002	
🔧	SRVname	MBUS name	3118	MODBUS_Epack[000A8D390002]	
🔧	IPMode	IP configuration mode (static - dhcp)	3109	Fixe (0) ▾	
	IPStatus	Status of the IP address	3111	0	
	IP	Current IP of the instrument	3114	192.168.0.25	
	cSubNetMas	Current SubNet mask IP	3115	255.255.255.0	
	cDefault_Gat	Current Default Gateway IP address	3116	192.168.0.1	
	PrefMaster	Preferred Master IP address	3105	192.168.0.1	
	Address	Adresse Comms	3101	255	
🔧	IP_address	IP address.	3102	192.168.0.25	
🔧	Subnet_Mas	IP address of the subnet mask	3103	255.255.255.0	
🔧	Default_Gate	IP address of the default gateway	3104	192.168.0.1	
	MAC12	Adresse MAC 1	3106	2560	
	MAC34	Adresse MAC 2	3107	14733	
	MAC56	AdresseMAC3	3108	512	
	Timeout	Comms Timeout in ms.	3110	5000	
	Fallback1	Fallback1	3112	1	
	Fallback2	Fallback2	3113	0	
	EnTimeout	Timeout Enable	3117	Sans (0) ▾	
	Protocol	Protocole Comms	3100	ModbusTCP (0) ▾	
	IOgateway	IO Gateway Access	4744	0	
🔧	LinkSpeed	Speed of the ethernet link.	3149	Auto Nego (0) ▾	
	TCPTimeout	TCP Comms Timeout in ms.	3150	5000	
	TCPCounter	TCP Counter	3151	0	
	TCP_Open	TCP Number Open Connection	3152	1	

They can also be entered using iTools under this form 'abc.def.ghi.jkl'.

This also applies to the SubNet Mask and Default Gateway IP Address.

In EPack controller units MAC addresses are shown as 3 separate hexadecimal values on an EPack instrument itself or decimal values in iTools. MAC1 shows the first address value (aa), MAC2 shows the second address value (bb) and so on.

Dynamic IP Addressing

IP addresses may be 'fixed' - set by the user, or dynamically allocated by a DHCP server on the network. When IP addresses are dynamically allocated the server uses the instrument MAC address to uniquely identify them.

To configure dynamic IP addressing, the user must first set the IPMode parameter to *DHCP*.

Once connected to the network and powered, the instrument will acquire its "IP address", "SubNet Mask" and "Default Gateway" from the DHCP Server automatically and display this information within a few seconds.

NOTE: If the DHCP server does not respond (in common with other Ethernet appliances in this situation) the unit will not be accessible via the network. Instead, the unit will default to an automatic IP mode with an IP address in the range of 169.254.xxx.xxx.

Fixed IP Addressing

IP addresses may be 'fixed' - meaning the user manually enters the IP address and SubNet Mask values, which will remain unchanged, before connecting the instrument to the network.

To configure fixed IP addressing, the instrument must be powered and the user must first set the IPMode parameter to *Fixed*.

Then set the IP address and SubNet Mask as required, to configure a fixed IP address, see [Comms menu \(page 89\)](#).

Default Gateway

The "Comms" folder also includes configuration settings for "Default Gateway". These parameters will be set automatically when Dynamic IP Addressing is used. When fixed IP addressing is used these settings are only required if the instrument needs to communicate wider than the local area network.

Figure 24 shows the appearance of EtherNet/IP User Comms configuration parameters in iTools:-

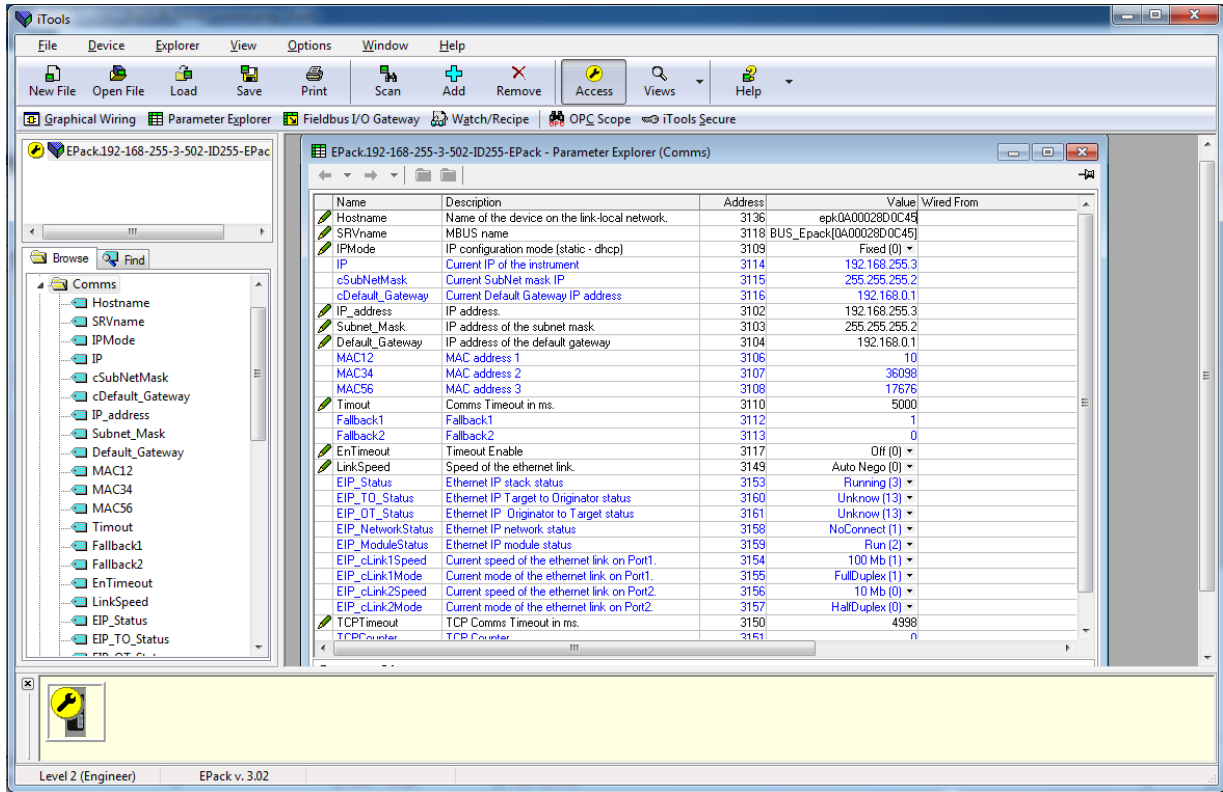

Figure 24 EtherNet/IP Comms Parameters

Data Exchange Mapping

Up to 32 input and 16 output - parameter variables may be included in the EtherNet/IP cyclic (implicit) data exchange.

By default, the most frequently used values are included, but it is possible to select other parameters within the unit. The default mapping is as follows:

Input Definition	Output Definition
FaultDetAnyAlarm	SetProv.Remote2
Control.Main.PV	
Control.Main.SP	
Network.Meas.I	
Network.Meas.V	

Input and Output Parameters are 16 bits (2 bytes) each.

To set up the EPack controller unit so that the desired parameters can be read and written involves setting up the INPUT and OUTPUT data tables. This is carried out using iTools.

Configuring The Cyclic (Implicit) Data Exchange

The EtherNet/IP master may be required to work with many diverse slaves from different manufacturers and with different functions. Furthermore EPack controller units contain many parameters most of which will not be required by the network master for a particular application. It is, therefore, necessary for the user to define which Input and Output parameters are to be available on the EtherNet/IP network. The master may then map the selected device parameters into the PLC input/output registers.

Values from each slave, 'Input Data', are read by the master, which then runs a control program. The master then generates a set of values, 'Output Data', into a pre-defined set of registers to be transmitted to the slaves. This process is called an 'I/O data exchange' and is repeated continuously, to give a cyclical I/O data exchange.

The Input/Output definitions for EtherNet/IP are configured using iTools.

Select the 'Fieldbus I/O Gateway' tool from the lower toolbar, and an editor screen will appear similar to that shown in Figures 25.

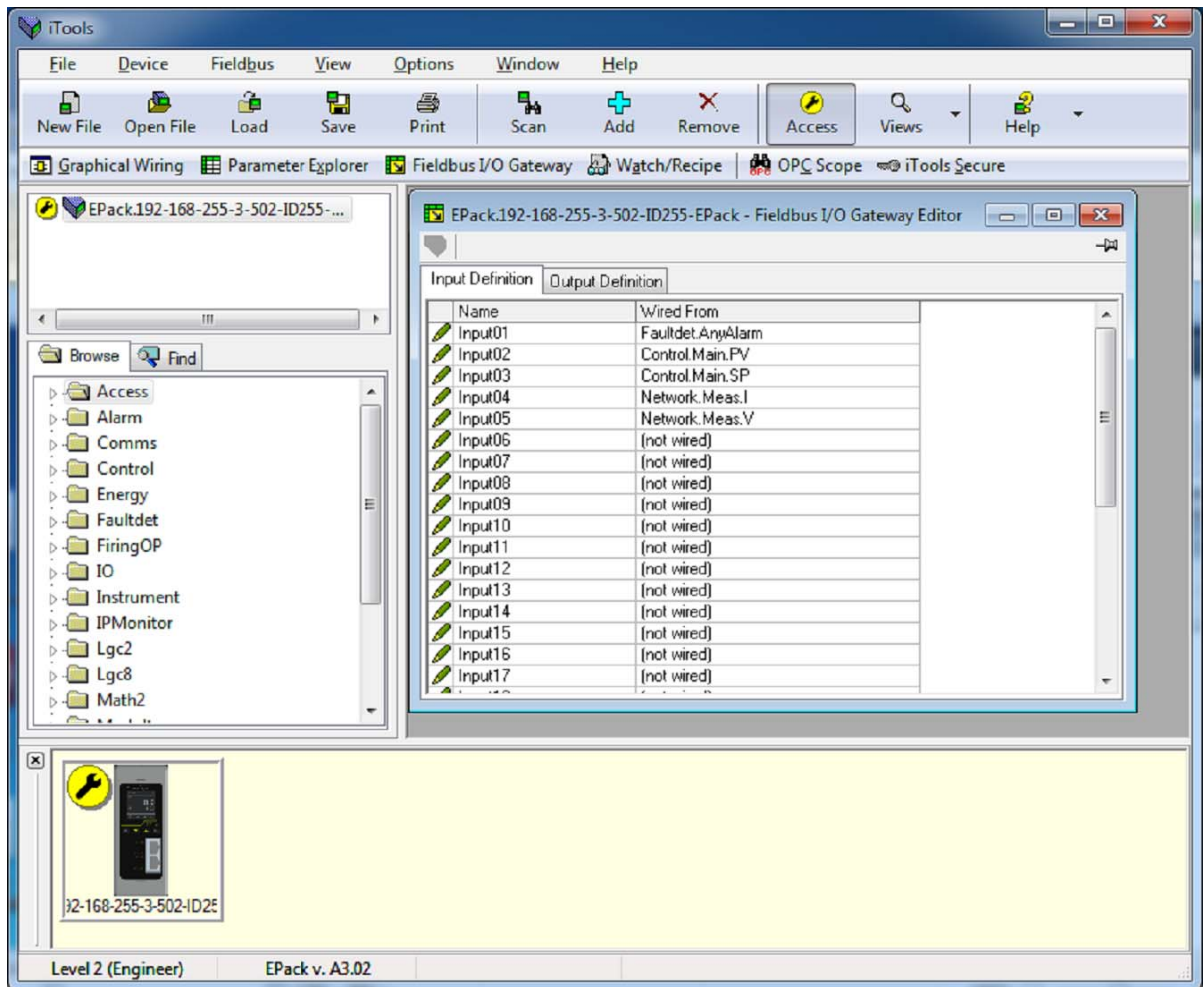

Figure 25 The I/O (Fieldbus I/O Gateway) Editor in iTools

There are two tabs within the editor, one for the definition of Inputs, and the other for Outputs. 'Inputs' are values sent from the EPack controller to the EtherNet/IP master, for example, alarm status information or measured values, i.e. they are readable values.

'Outputs' are values received from the master and used by the EPack controller, for example, setpoints written from the master to EPack controller. Note that Outputs are written on every EtherNet/IP cycle, which is frequent, of the order of 100mS, and so values from EtherNet/IP will overwrite any changes made on the EPack controller keypad unless special measures are taken to prevent this.

The procedure for selecting variables is the same for both input and output tabs. Double click the next available position in the input or output data and select the variable to assign to it. A pop-up provides a browser from which a list of parameters can be opened. Double click the parameter to assign it to the input definition. Note that you should assign inputs and outputs contiguously, as a 'not wired' entry will terminate the list even if there are assignments following it.

Figures 26 shows an example of the pop-up and the input list produced.

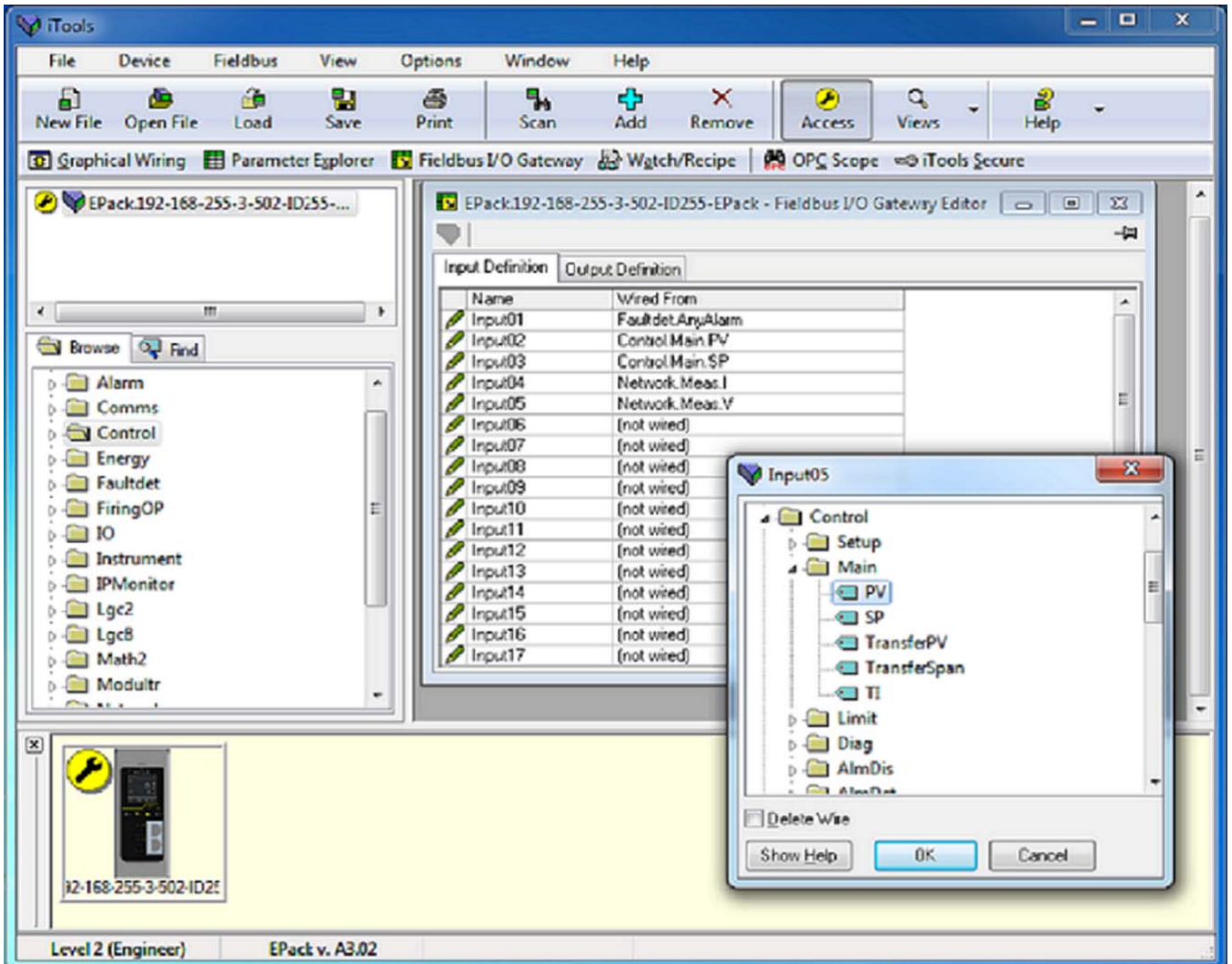



Figure 26 Selecting an Input Value and Example of an Input List

When the list is populated with the variables you require, note how many 'wired' entries are included in the input and output areas as this will be needed when setting up the EtherNet/IP Master. In the example above, there are five input values, each of two bytes in length, so a total of 10 bytes of data. Note this number, as it is required when setting the I/O length when configuring the EtherNet/IP master.

Note that no checks are made that output variables are writeable and if a read only variable is included in the output list, any values sent to it over EtherNet/IP will be ignored with no error indication.

Once the changes have been made to the I/O lists, they must be downloaded to the E-Pack controller unit.

This is done with the button on the top left of the I/O Editor marked  .

The E-Pack controller Unit will need to be powered off and on again once this has been done for the changes to register.

The next step in the process is to configure the EtherNet/IP master.

Setting Up The Master

An example of a master may be a CompactLogix L23E QB1B PLC from Allen Bradley. With this example, there are 2 methods supplied to set up the PLC EtherNet/IP Master using;

- RSLinx (RSLinx Classic Lite & EDS Wizard)
- RSLogix 5000

Cyclic (Implicit) Data Exchange

Example: EDS file Import Wizard (RSLinx Tools)

It is necessary to import an EDS (Electronic Data Sheet) file. The EDS file is designed to automate the EtherNet/IP network configuration process by precisely defining the required device parameter information. Software configuration tools utilise the EDS file to configure an EtherNet/IP configuration.

It is available from your supplier, or electronically from [E-Pack Power Controller Downloads](#).

EDS File Import

1. Connect E-Pack power controller to Rockwell Instrument.
2. Launch the EDS Hardware Installation Tool by selecting Start > All Programs > Rockwell Software > RSLinx > Tools.

The Rockwell Automation - Hardware Installation Tool displays.

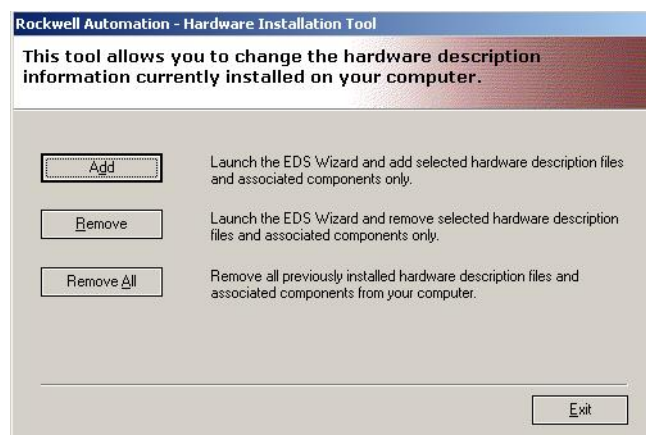

Figure 27 Hardware Installation Tool

- 3. Select *Add*.
- 4. Select *Register a single file* and click *Browse*.



Figure 28 EDS file Registration

- 5. Navigate to and select file *EPack_V300.eds* stored locally, then click *Open*.

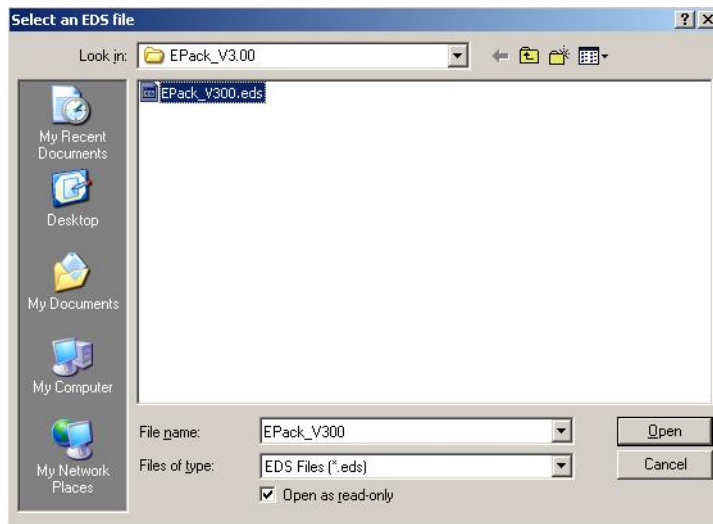

Figure 29 EDS file selection

- 6. Click *Next*. The EDS file installation test results are displayed, indicated by the green tick left of the file location in the below panel.

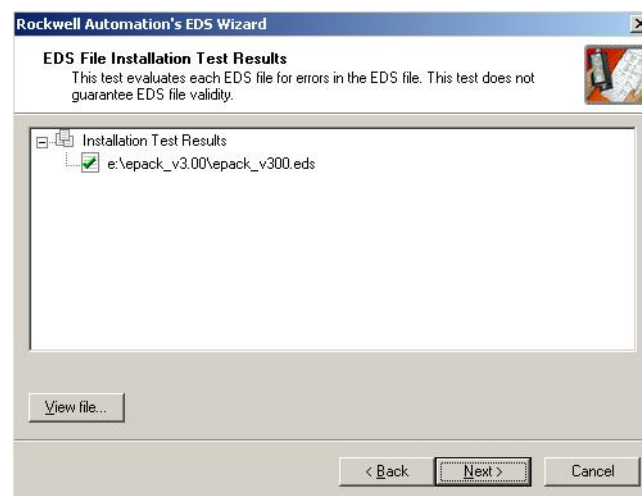

Figure 30 EDS file installation test results

7. Select *Next*.

The Change Graphic Image option appears. This stage allows user to change the icon associated with the device being set up. The EPack EDS file provides a default EPack icon, so no changes are required.

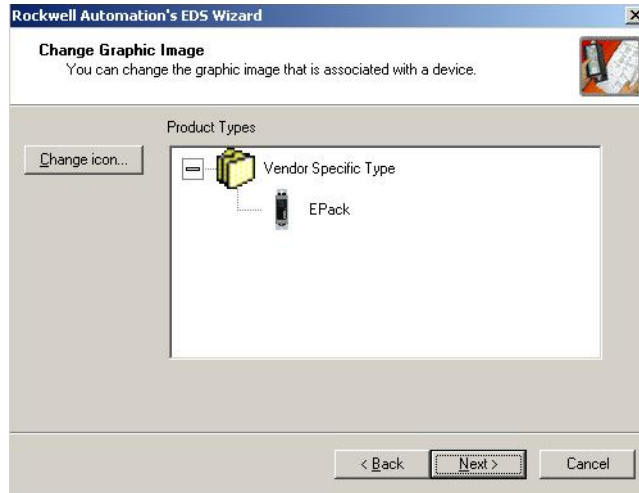

Figure 31 EDS wizard, change graphic image option

8. Select *Next*.

The Final Task Summary information appears, displaying a summary of the device being registered.



Figure 32 EDS wizard install summary

- Review, confirm device name is correct, then select *Next* to continue.

The final EDS wizard panel, appears confirming you have successfully completed the installing the EDS file for EPack.



Figure 33 EDS wizard successfully completed

- Select *Finish* to complete and close the EDS Wizard.

Network Driver - Configuration (using RSLinx Classic Lite)

- Start *RSLinx* program located in Start > All Programs > Rockwell Software.

The *RSLinx Classic Lite* program launches.

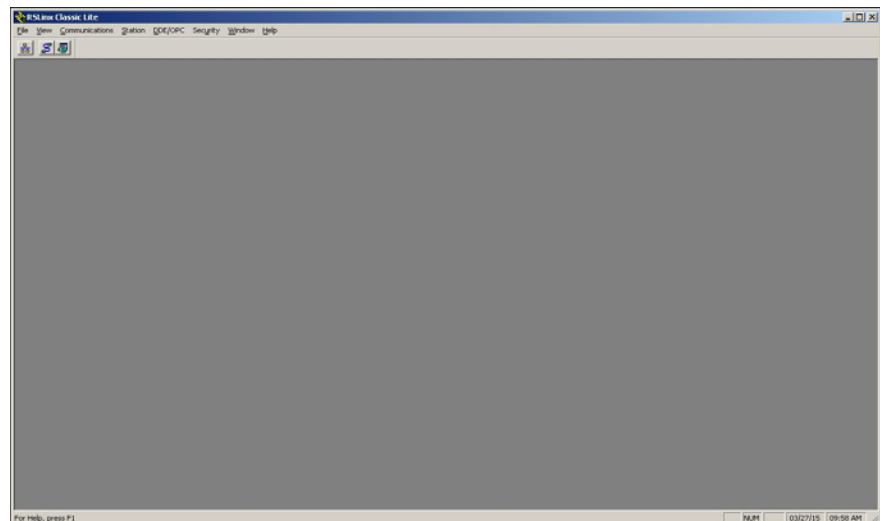

Figure 34 RSLinx Classic Lite

2. Select *RSWho*, from the *Communications* menu

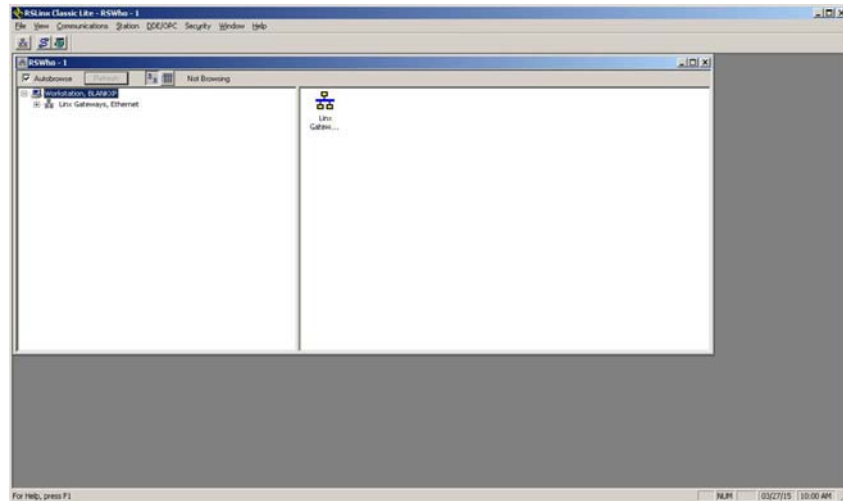

Figure 35 RSLinx Classic, Comms menu, RSWho selected

3. Launch the *Configure Drivers* panel.
The *Configure Drivers* panel appears.
4. From the *Available Driver Types* drop down menu, select *EtherNet/IP Driver*.
5. Click *Add New*, enter relevant name for driver, then click *Configure..* button.

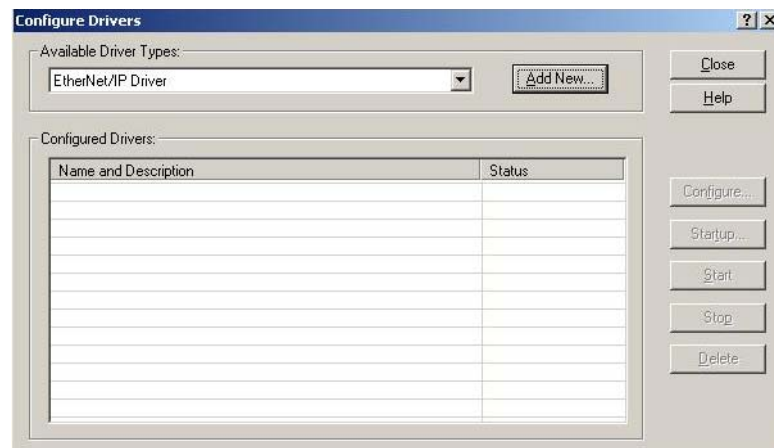

Figure 36 RSLinx Classic configure driver

The *Configure Driver*: panel is displayed.

6. To link the driver with your PC's Ethernet network connection, selecting a the relevant driver option listed below the *Description* field, on the *Configure driver* panel.

7. Click *Apply*, then *OK* to complete the driver linking process.

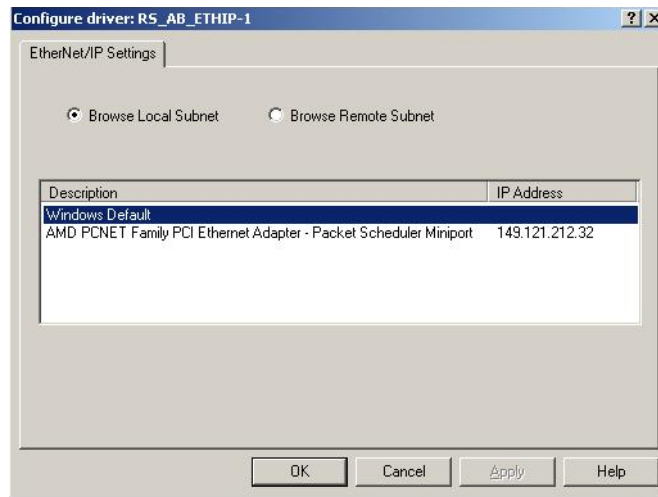

Figure 37 RSLinx Classic configure driver EtherNet/IP settings

Now you are in a position to browse your network and locate EPack.

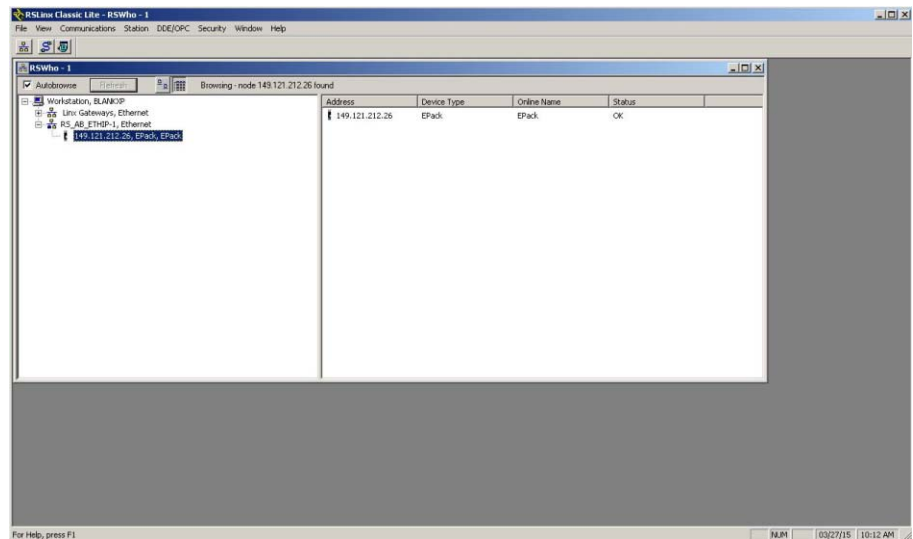

Figure 38 RSLinx Classic, EPack on network

Example: Using RSLogix 5000

In I/O configuration, select "New Module" and select "Generic Ethernet module"

In the next dialogue window, RSLogix 5000 will ask for information regarding the communication to the EPack EtherNet/IP Slave module.

First enter a name for the EPack EtherNet/IP Slave module : eg 'EPack'.

This name will create a tag in RSLogix 5000, which can be used to access the memory location in the PLCs memory where the data for the EPack Slave module will be stored.

Next step is to select the "Comm Format", which tells RSLogix5000 the format of the data. Select Data-INT, which will represent the data as 16-bit values. (EPack I/O parameters, defined by the iTools Fieldbus I/O Gateway Editor, are 16 bit values).

I/O data is accessed in Input Instance 100 and Output Instance 150, so these values have to be entered as the instance values for input and output.

The size of the input connection and the output connection shall correspond to the size that has been defined by the 'iTools Fieldbus I/O Gateway Editor' Input and Output Definitions for the EPack slave.

That is :-

Input size (5 parameters by default (10 bytes), maximum parameters 32) = Number of 'I/O Gateway' Input Parameter definitions.

Output size (1 parameter by default (2 bytes), maximum parameters 16) = Number of 'I/O Gateway' Output Parameter definitions.

The EPack EtherNet/IP Slave module does not have a configuration assembly instance, but RSLogix5000 requires a value for this anyway. An instance value of 0 is not a valid instance number, but any non-zero value will work, so use a value 5. The data size of the configuration instance has to be set to 0, otherwise the configuration instance will be accessed and the connection will be refused.

As a final step enter the IP address that has been configured for the EPack EtherNet/IP slave module.

Summary: Cyclic (implicit) I/O Data Exchange setup information:-

	Assembly Instance	Data Size
INPUT	100	2 Bytes per "iTools Fieldbus I/O Gateway" Input Parameter Definition
OUTPUT	150	2 Bytes per "iTools Fieldbus I/O Gateway" Output Parameter Definition
CONFIGURATION	199	0

Establishing Communications

Communications will commence when the EtherNet/IP network is correctly cabled and powered, the Master (e.g. PLC) and Slave (EPack power controller) are configured with valid unique IP addresses and I/O parameter data definitions are setup.

The Input/Output definitions need to be matched with Master (e.g. PLC) data registers.

Parameters are either INPUT parameters read by the EtherNet/IP Master or OUTPUT parameters written by the EtherNet/IP Master.

Data Formats

Data is returned as 'scaled integers', such that 999.9 is returned or sent as 9999; 12.34 is encoded as 1234. The control program in the EtherNet/IP master must convert the numbers into floating point values if required.

The EDS File

The EtherNet/IP EDS (Electronic Data Sheet) file for EPack controller is named:

EPACK_Vx.xx.eds (with Vx.xx representing the EPack software version).

It is available from your supplier, or electronically by going to web site www.eurotherm.com.

The EDS file is designed to automate the EtherNet/IP network configuration process by precisely defining the required device parameter information. Software configuration tools utilise the EDS file to configure an EtherNet/IP network.

NOTE: The EDS file is automatically installed when you upgrade your unit and is located in C:\Program files (x86)\EPack_Vx.xx.

Troubleshooting

No Communications:

- Check the cabling carefully, ensure that Ethernet plugs are fully located in the sockets.
- Check the 'Comms' list in configuration level and, check that the parameter 'Protocol' provides both options 'Modbus TCP and EIP' (EtherNet/IP). If not, your EPack power controller has not got the EIP option enabled, contact your local distributor.
- Check that the 'IP Address', 'Subnet Mask' and 'Gateway' in the 'Comms' list are correct and unique for the network configuration in use.
- Ensure that the EtherNet/IP Master Module Input and Output Parameter mapping is correctly matched. If the master is attempting to read (input) or write (output) more data than has been registered on the EPack slave, using the iTools I/O Gateway Editor, the EPack slave will refuse the connection.
- If possible, replace a faulty device with a duplicate and retest.

Modbus

It is not within the scope of this manual to describe the MODBUS/TCP network and for this you should refer to information which may be found at <http://www.modbus.org/>.

Also refer to HA179770 EPower Communication Manual.

Overview

EPack controller units support the Modbus/TCP protocol using Ethernet. This protocol embeds the standard Modbus protocol within an Ethernet TCP layer.

As most parameters are saved in the EPack controller unit's memory, the interface board must retrieve these values before it can start communicating on Ethernet.

Changing any of the IP parameters will cause the interface board to reset in order to retrieve the new values. Any socket left with no data traffic for 2 minutes will be disconnected and made available for new connections.

Protocol Basics

A data communication protocol defines the rules and structure of messages used by all devices on a network for data exchange. This protocol also defines the orderly exchange of messages, and the detection of errors.

Modbus defines a digital communication network to have only one MASTER and one or more SLAVE devices. Either a single or multi-drop network is possible. The two types of communications networks are illustrated in the diagram below;

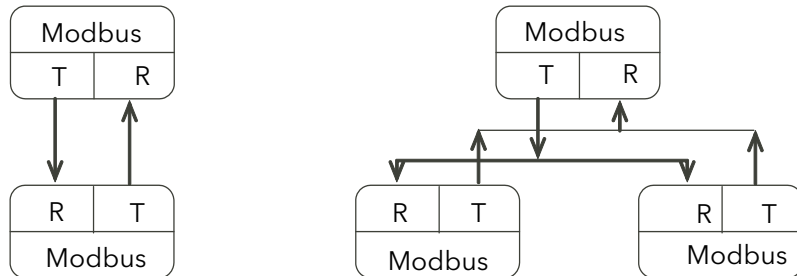

Figure 39 Single Serial Link and Multi Drop Serial Link

A typical transaction will consist of a request sent from the master followed by a response from the slave.

The message in either direction will consist of the following information;

Device Address	Function Code	Data	Error Check Data	End of Transmission
----------------	---------------	------	------------------	---------------------

On a network of instruments this address is used to specify a particular instrument. Each instrument on a network must be set to a unique address, the available address range depending upon the network protocol.

As EPack supports only Modbus/TCP protocol and discrimination on the network is carried out using the IP addresses of the connected instruments, the Modbus addresses of the devices are not used.

Each slave has a unique 'device address':

- The device address 0 is a special case and is used for messages broadcast to all slaves. This is restricted to parameter write operations.
- EPack controller supports a subset of Modbus function codes.
- The data will include instrument parameters referenced by a 'parameter address'
- The Device Address is a single byte (8-bits) unique to each device on the network.
- Function Codes are a single byte instruction to the slave describing the action to perform.
- The Data segment of a message will depend on the function code and the number of bytes will vary accordingly.
- Typically the data segment will contain a parameter address and the number of parameters to read or write.
- The Cyclic Redundancy Check, (CRC) is an error check code and is two bytes, (16 bits) long.
- The End of Transmission segment, (EOT) is a period of inactivity 3.5 times the single character transmission time. The EOT segment at the end of a message indicates to the listening device that the next transmission will be a new message and therefore a device address character.

Parameter Resolution

Modbus protocol limits data to 16 bits per parameter. This reduces the active range of parameters to 65536 counts. In EPack controller units this is implemented as -32767 (8001h) to +32767 (7FFFh).

The protocol is also limited to integer communication only. EPack controller units allow full resolution. In full resolution mode the decimal point position will be implied so that 100.01 would be transmitted as 10001. From this, and the 16 bit resolution limitation, the maximum value communicable with 2 decimal place resolution is 327.67. The parameter resolution will be taken from the slave user interface, and the conversion factor must be known to both master and slave when the network is initiated.

EPack controller units provide a special sub-protocol for accessing full resolution floating point data. This is described in "Access to Full Resolution Floating Point and Timing Data" on page 71.

Reading of Large Numbers

Large numbers being read over digital communications are scaled. For example, Setpoint can have the maximum value of 99,999 and is read as nnn.nK or 100,000 = 100.0K and 1,000,000 = 1000.0K.

EPack implements a dedicated scale parameter for each large parameter, allowing users to do specific scaling to suit their type of application.

Wait Period

There are several errors for which the slave devices on the network are unable to make a response:

- If the master attempts to use an invalid address then no slave device will receive the message.
- For a message corrupted by interference, the transmitted CRC will not be the same as the internally calculated CRC. The slave device will reject the command and will not reply to the master.

After a wait period, the master will re-transmit the command.

The wait period should exceed the instrument latency plus the message transmission time. A typical wait period, for a single parameter read, is 100ms.

Latency

The time taken for an EPack controller unit to process a message and start the transmission of a reply is called the latency. This does not include the time taken to transmit the request or reply.

The parameter functions read 1 word (function 03h), write 1 word (function 06h), and loopback (function 08h) are processed within a latency of between 20 and 120ms (typically 90).

For the parameter functions read n words (function 03h) and write n words (function 16h) the latency is indeterminate. The latency will depend on the instrument activity and the number of parameters being transferred and will take from 20 to 500ms.

Configuration Mode Parameters

To write parameters in this group, it is first necessary to set the 'Access.IM' parameter (Modbus 199 – 00C7_{hex}) to the value 2 to set the controller into configuration mode. Note this will disable all normal control action and the controller outputs will be switched to a safe state.

It is not necessary to set any 'password' parameters to enter configuration mode.

To exit from configuration mode, simply write 0 to instrument mode. This will reset the controller, a process that takes several seconds. During this period it will not be possible to communicate with the controller.

Modbus Advanced Topics

Access to Full Resolution Floating Point and Timing Data

One of the main limitations of Modbus is that only 16 bit integer representations of data can normally be transferred. In most cases, this does not cause a problem, since appropriate scaling can be applied to the values without losing precision. Indeed all values displayable on the 4 digit EPack controller front panel may be transferred in this way. However, this has the significant drawback that the scaling factor to be applied needs to be known at both ends of the communications link.

One further problem is that certain 'time' parameters, are always returned over the communications link in either 10th of seconds or 10th of minutes, configured via `Instrument.Configuration.TimerRes`. It is possible for long durations to overflow the 16 bit Modbus limit.

To overcome these problems, a sub protocol has been defined, using the upper portion of the Modbus address space (8000h and upwards), allowing full 32 bit resolution floating point and timer parameters. The upper area is known as the IEEE region.

This sub-protocol provides two consecutive Modbus addresses for all parameters. The base address for any given parameter in the IEEE region can easily be calculated by taking its normal Modbus address, doubling it, and adding 8000h. For example, the address in the IEEE region of the Target Setpoint (Modbus address 2) is simply

$$2 \times 2 + 8000h = 8004h = 32772 \text{ decimal}$$

This calculation applies to any parameter that has a Modbus address.

Access to the IEEE area is made via block reads (Functions 3 & 4) and writes (Function 16). Attempts to use the 'Write a Word' (Function 6) operation will be rejected with an error response. Furthermore, block reads and writes using the IEEE region should only be performed at even addresses, although no damage to the instrument will result in attempting access at odd addresses. In general, the 'number of words' field, in the Modbus frame, should be set to 2 times what it would have been for 'normal' Modbus.

The rules governing how the data in the two consecutive Modbus addresses are organised depending on the 'data type' of the parameter.

Data Types Used In EPack Power Controller Units

- Enumerated parameters are parameters which have a textual representation for their value on the user interface, for example, 'Parameter Status' – 'Good/Bad', 'Analog Operator Type' – 'Add', 'Subtract', 'Multiply', etc.
- Booleans are parameters which can have either a value '0' or a value '1'. Generally these parameters are enumerated. These are denoted as 'bool' in the table.
- Status words are generally only available over communications, and are used to group binary status information.
- Integer parameters are those that never include a decimal point however the instrument is configured, and do not refer to a time period or duration. These include such values as the instrument communications address and values used to set passwords, but not Process Variable and Setpoint related parameters, even if the display resolution of the instrument is set to no decimal places. These may be 8 or 16 bit and are denoted by 'uint8' or 'uint16' unsigned integers or 'int8' or 'int16' signed (+ or -) integers.
- Floating point parameters are those having a decimal point (or those which may be configured to have a decimal point), with the exception of parameters relating to time periods and duration. This includes Process Variable, Setpoints, Alarm Setpoints, etc and are denoted as type 'Float32' (IEEE 32-bit floating point parameters).
- Time Type parameters measure durations, for example, Alarm time above threshold, Timer elapsed time, etc. These are denoted by 'time32' in the parameter table.

Enumerated, Status Word, and Integer parameters

These use only the first word of the 2 Modbus addresses assigned to them in the IEEE area. The second word is padded with a value of 8000 hex.

Although 'Write a Word' (Function 6) is not permitted, this type of parameter may be written as a single 16 bit word using a Modbus 'Block Write' (Function 16). It is not necessary to add a padding value in the second address. Similarly, such parameters may be read using a Modbus 'Block Read' (Function 3 & 4) as single words, in which case the padding word will be omitted.

It is, however, necessary to pad the unused word when writing this sort of data types as part of a block containing other parameter values.

Floating Point Parameters

These use the IEEE format for floating point numbers, which is a 32 bit quantity. This is stored in consecutive Modbus addresses. When reading and writing to floats, it is necessary to read or write both words in a single block read or write. It is not possible, for example, to combine the results of two single word reads.

This format is used by most high level programming languages such as 'C' and BASIC, and many SCADA and instrumentation systems allow numbers stored in this format to be decoded automatically. The format is as follows:

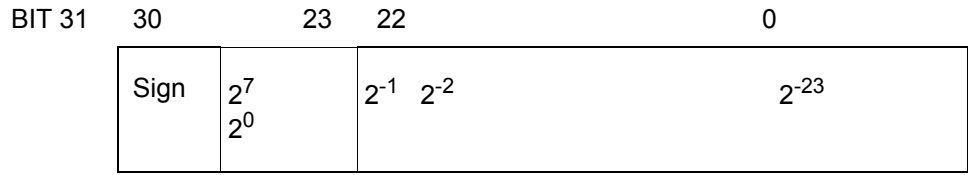

$$\{ \text{--- EXPONENT---} \} \{ \text{----- FRACTION-----} \}$$

where value = (-1) Sign x 1.F x 2 E-127

That in practice, when using C, IEEE floats may usually be decoded by placing the values returned over comms into memory and 'casting' the region as a float, although some compilers may require that the area be byte swapped high to low before casting. Details of this operation are beyond the scope of this manual.

The format used to transfer the IEEE number is as follows.

Lower Modbus Address		Higher Modbus Address	
MSB	LSB	MSB	LSB
Bits 31 - 24	Bits 16 - 23	Bits 15 - 8	Bits 7 - 0

For example, to transfer the value 1.001, the following values are transmitted (hexadecimal).

Lower Modbus Address		Higher Modbus Address	
MSB	LSB	MSB	LSB
3F	80	20	C5

Time Type Parameters

Time type values are returned over comms in 1/10 seconds or minutes. This can be changed in the SCADA table. Time durations are represented as a 32 bit integer number of milliseconds in the IEEE area. When reading and writing to time types, it is necessary to read or write both words in a single block read or write. It is not possible, for example, to combine the results of two single word reads.

The data representation is as follows.

Lower Modbus Address		Higher Modbus Address	
MSB	LSB	MSB	LSB
Bits 31 - 24	Bits 16 - 23	Bits 15 - 8	Bits 7 - 0

To create a 32 bit integer value from the two Modbus values, simply multiply the value at the lower Modbus address by 65536, and add the value at the Higher address. Then divide by 1000 to obtain a value in seconds, 60000 for a value in minutes, etc.

For example, the value of 2 minutes (120000 mS) is represented as follows:

Lower Modbus Address		Higher Modbus Address	
MSB	LSB	MSB	LSB
00	01	D4	C0

ETHERNET (MODBUS TCP)

Instrument setup

It is recommended that the communications settings for each instrument are set up before connecting it to any Ethernet network. This is not essential but network conflicts may occur if the default settings interfere with equipment already on the network.

For the Ethernet instruments, however, there are several more: IP address, subnet mask, default gateway and DHCP enable. See .

Changing any one of these parameters may immediately move the instrument to a new network address. For this reason, it is recommended that such changes are made offline.

IP Addresses are usually presented in the form "abc.def.ghi.jkl". In the instrument Comms folder each element of the IP Address is shown and configured separately such that IPAdd1 = abc, IPAddr2 = def, IPAddr3 = ghi and IPAdr4 = jkl.

This also applies to the SubNet Mask, Default Gateway and Preferred Master IP Address.

Each Ethernet module contains a unique MAC address, normally presented as a 12 digit hexadecimal number in the format "aa-bb-cc-dd-ee-ff".

In EPack controller units MAC addresses are shown as 3 separate **decimal** values in iTools. MAC1 shows the first pair of digits **in decimal**, MAC2 shows the second pair of digits and so on.

Dynamic IP Addressing

IP addresses may be 'fixed' - set by the user, or dynamically allocated by a DHCP server on the network. When IP addresses are dynamically allocated the server uses the instrument MAC address to uniquely identify them.

To configure dynamic IP addressing, the user must first set the IPMode parameter to *DHCP*.

Once connected to the network and powered, the instrument will acquire its "IP address", "SubNet Mask" and "Default Gateway" from the DHCP Server automatically and display this information within a few seconds.

NOTE: If the DHCP server does not respond (in common with other Ethernet appliances in this situation) the unit will not be accessible via the network. Instead, the unit will default to an automatic IP mode with an IP address in the range of 169.254.xxx.xxx.

Fixed IP Addressing

IP addresses may be 'fixed' - meaning the user manually enters the IP address and SubNet Mask values, which will remain unchanged, before connecting the instrument to the network.

To configure fixed IP addressing, the user must first set the IPMode parameter to *Fixed*.

Then set the IP address and SubNet Mask as required, to configure a fixed IP address, see .

Default Gateway

The "**Comms**" folder also includes configuration settings for "**Default Gateway**", these parameters will be set automatically when Dynamic IP Addressing is used. When fixed IP addressing is used these settings are only required if the instrument needs to communicate wider than the local area network i.e. over the internet.

Preferred Master

The "**Comms**" folder also includes configuration settings for "**Preferred Master**". Setting this address to the IP Address of a particular PC will guarantee that one of the available Ethernet sockets will always be reserved for that PC.

iTools Setup

iTools configuration package, version V7 or later, may be used to configure Ethernet communications.

The following instructions configure an Ethernet.

Automatic Configuration

Both EPack power controllers and iTools software support automatic discovery of network connected instruments. iTools software display all instruments connected to the network automatically. To connect and communicate with a selected instrument start iTools, click the *Add* button and select the relevant instrument.

Manual Configuration

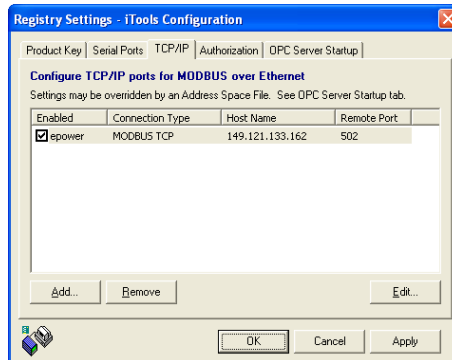

To include a Host Name/Address within the iTools scan:-

1. Ensure iTools is **NOT** running before taking the following steps
2. Within Windows, select **'Control Panel'**
3. In control panel select **'iTools'**
4. Within the iTools configuration settings select the **'TCP/IP'** tab
5. Click the **'Add'** button to add a new connection
6. Enter a name for this TCP/IP connection
7. Click the **'Add'** button to add the host name or IP address of the instrument in the **'Host Name/ Address'** section
8. Click **'OK'** to confirm the new Host Name/IP Address you have entered
9. Click **'OK'** to confirm the new TCP/IP port you have entered
10. You should now see the TCT/IP port you have configured within the TCP/IP tab of the iTools control panel settings

iTools is now ready to communicate with an instrument at the Host Name/IP Address you have configured.

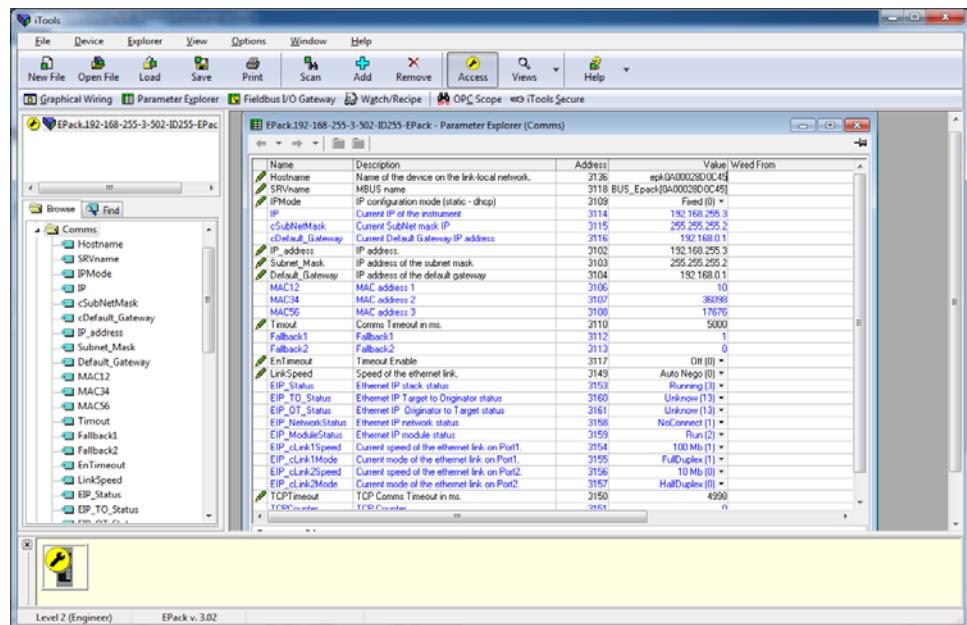

Figure 40 iTools - Ethernet Communications Parameter

PROFINET

NOTE: Communication option PROFINET is not currently available at version 5.0 release.

PROFINET is the open industrial Ethernet based networking solution for automation. It is similar to PROFIBUS in that it enables distributed IO control from a PLC. PROFINET uses TCP/IP and IT standards, and is, in effect, real-time Ethernet. It enables the integration of existing Fieldbus systems like PROFIBUS, DeviceNet, and Interbus, without changes to existing devices.

PROFINET IO was developed for real time (RT) and isochronous real time IRT (Isochronous Real Time) communication with the decentral periphery. The designations RT and IRT merely describe the real-time properties for the communication within PROFINET IO.

There are four stages to setting up a network:

- "PROFINET Wiring" on page 78
- "Setting up the EPack Controller for Profinet" on page 79
- "Cyclic Data Exchange (PROFINET IO Data)" on page 83
- "Acyclic Data Exchange (Record Data)" on page 84

NOTICE

1. The PROFINET certification is pending.
2. The PROFINET protocol and the Ethernet/IP protocol cannot be used together. Select one of the appropriate Protocol among the different options see [Software upgrade \(page 199\)](#).

PROFINET Features (certification pending)

- 100Mbit, full duplex operation
- Galvanically isolated bus electronics
- Field pluggable option
- Polled and Explicit I/O messaging connection
- PROFINET IO Device version: V2.31
- Device Type: Compact field device
- Conformance class: CC-A
- Real Time class: RT-1
- Supported Net Load class: Class 1
- Number of slots: 2 (Input data / Output data)
- Minimum Device interval (cycle time): 8ms

PROFINET Wiring

PROFINET capability is provided by the RJ45 Ethernet port, [Network Communications \(page 39\)](#).

The PROFINET port is a 100 Mbit, full duplex operation port and should be connected via an industrial switch to a Master device (eg PLC) with Cat5e (straight through) cable via the standard RJ45 connector (maximum length 100M).

The interconnecting cables should be fitted with plugs provided with an outer metallic shell with the shell connected to the wire screen of the cable. Suitable cables are available from Eurotherm and can be ordered as:

2500A/CABLE/MODBUS/RJ45/RJ45/0M5 Cable 0.5 metres long

2500A/CABLE/MODBUS/RJ45/RJ45/3M0 Cable 3.0 metres long

This type of cable must be used to maintain EMC compliance.

All network communications lines must be terminated using the appropriate impedance. To simplify installation a plug-in line terminator is available, order code:

2500A/TERM/MODBUS/RJ45

This can be plugged into the free socket in the last EPack controller unit in the chain, and provides correct terminating resistor values for CAT-5 cable.

NOTE: Although CC-A requirements can be met by the use of ordinary Ethernet Switches (supporting the VLANs), it is strongly recommended to use Industrial Switches (Managed Switches, e.g. MOXA EDS-408A-PN). This will allow future migration to the Conformance Class CC-B without the need to change your Network infrastructure (“Network Diagnostic” with SNMP, LLDP-MIB for the “Device Replacement without Engineering Tool”).

NOTE: The MAC address of the device is stated on the label side. To ensure the 'Neighborhood detection' functionality with LLDP, each physical Ethernet Port requires its own MAC address. Therefore, P1 uses the device MAC address incremented by one and by two for P2.

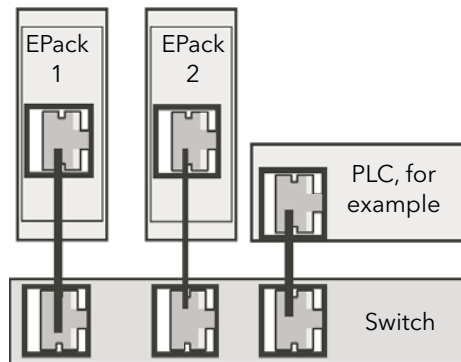

Figure 41 PROFINET Wiring - Multiple controllers

iTools Connection

Connect the EPACK Controller to the PROFINET Configuration tool and to iTools (see example below).

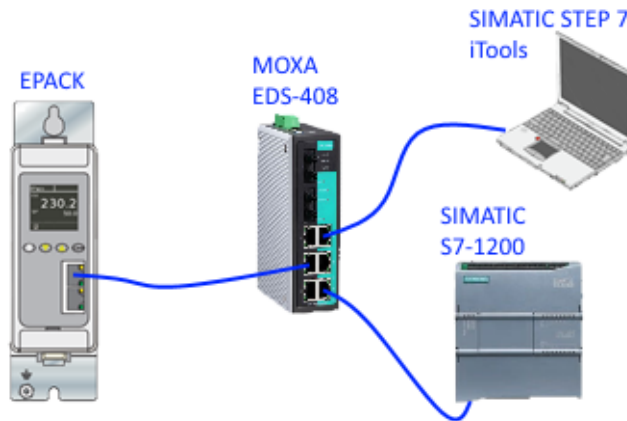

Figure 42 Configuration Tool Connections

Setting up the EPACK Controller for Profinet

A PROFINET IO Device, in this case EPACK, is generally commissioned by using a PROFINET configuration tool (typically STEP 7 included in the SIEMENS TIA Portal). Figures 42 shows a single controller but multiple controllers can be connected.

The first thing to do is to identify the PROFINET Device (EPack) on the Network. This is done automatically with the PROFINET tool which uses a specific DCP service for this purpose (DCP Identity Request).

Once done, you can affect the “Device Name” and the IP address configuration of a particular EPACK controller. This is also done with the PROFINET tool by following the procedure below.

Commissioning using DCP protocol

This section describes ‘Device Name’ and ‘IP Configuration’ assignment.

A PROFINET Device is characterised by its ‘Device Name’ (named also ‘Station Name’) and its IP address.

The configuration of a PROFINET device is based on the DCP protocol which is used specifically to assign the ‘Device Name’ or to assign the IP configuration (IP address, Network Mask ...).

An EPACK which is just ‘Out of the box’ has its ‘Device Name’ and its IP configuration address set to Null by default as shown in Figures 43 (the MAC address is used initially by the DCP protocol for setting up the ‘Device Name’).

NOTE: EPACK indicates that the ‘Device Name’ is reset by displaying ‘No Device Name !’.



Figure 43 E-Pack 'Comms' screen display 'as-delivered' (Device Name = "", IP Configuration = Null).

During the system set up, the PROFINET configuration tool first identifies the existing devices in the system (by sending out a 'DCPIdentity.req'), shown below in Figures 44. This example uses the © Siemens TIA Portal / STEP 7 ('Update accessible devices' function).

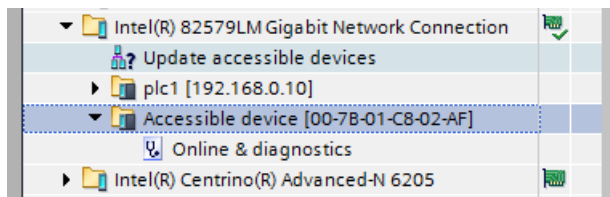

Figure 44 Example of E-Pack (not yet commissioned) MAC address using DCP. The next step assigns the 'IP Configuration' and the 'Device Name'. This operation can be performed by clicking on the 'Online & diagnostics' as shown in Figures 45.

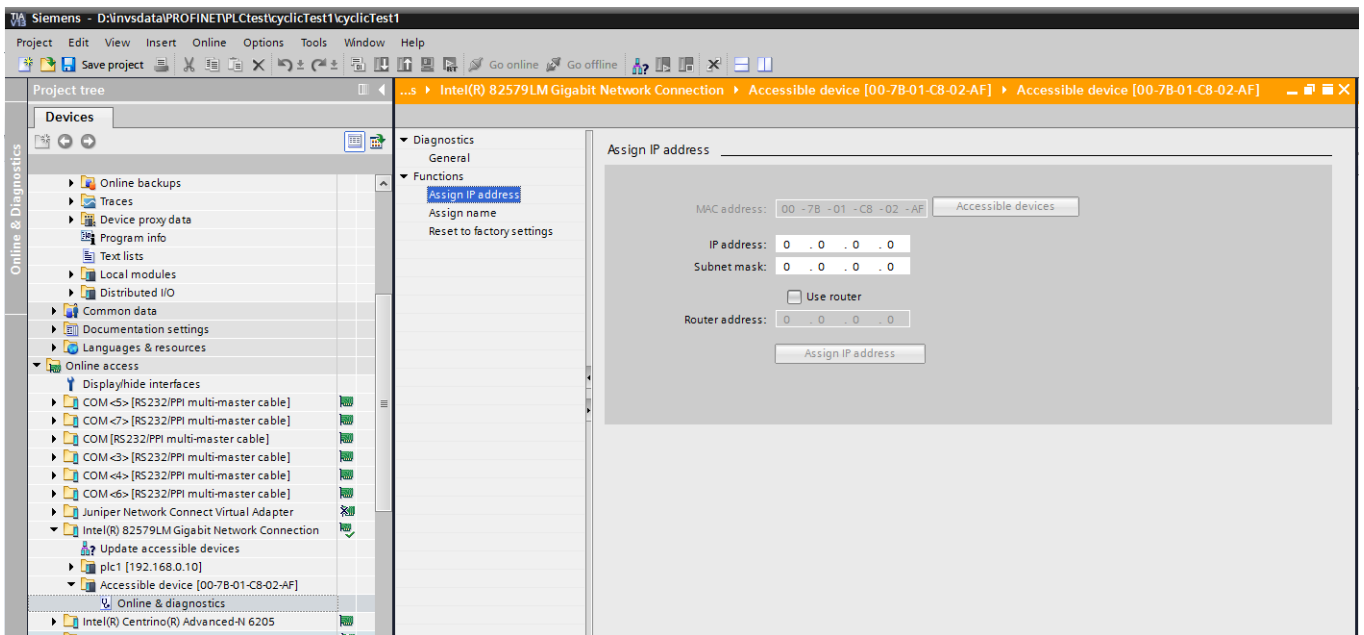

Figure 45 IP Configuration assignment and Device Name assignment with the "TIA Portal"

NOTE: The Default Gateway can be changed in the same way (named 'Router address' in this example).

Commissioning using 'Fixed IP Mode'

This section describes setting of an IP address manually.

As mentioned above, the DCP Protocol is the basis of PROFINET.

However, in some cases, it could be useful to set an IP address and a Subnet Mask manually. For example, using 'iTools' configuration package without having previously configured your EPack with a PROFINET configuration tool see [Commissioning using DCP protocol \(page 79\)](#).

This can be done by selecting the 'Fixed' IP Mode instead the 'DCP' protocol on the front face of the device during the 'Quickcode' operation - see [Quickcode \(page 45\)](#).

Finally, the DCP protocol always stays active as it is a main part of PROFINET. This means that the next time that the DCP protocol re-allocates a new IP address, this one will overwrite the previous IP address manually set.

NOTE: The DHCP mode is not accessible when the PROFINET protocol is active on EPack.

Setting up the IP configuration via iTools

The IP configuration can be changed through 'iTools', but this method is not recommended with PROFINET, especially because the IO Controller/PLC or the Supervisor cannot be informed of these changes.

The PROFINET 'ecosystem' must be privileged for this type of operation (PROFINET Configuration tool using the DCP protocol).

Device Name

The Device Name is used to identify a Device on a PROFINET node.

Device Name via the DCP protocol

The Device Name is written to the Device by the PROFINET configuration tool via the DCP protocol (see "Setting up the EPack Controller for Profinet" on page 79).

The length shall not exceed 240 characters, only the lower case characters are authorised to be used (see [Figure 46](#)).

This field shall be coded as data type OctetString with 1 to 240 octets. The definition of RFC 5890 and the following syntax applies:

- 1 or more labels, separated by [.]
- Total length is 1 to 240
- Label length is 1 to 63
- Labels consist of [a-z0-9-]
- Labels do not start with [-]
- Labels do not end with [-]
- The first label does not have the form "port-xyz" or "port-xyz-abcde" with a, b, c, d, e, x, y, z = 0...9, to avoid wrong similarity with the field AliasNameValue
- Station-names do not have the form n.n.n.n, n = 0...999

Figure 46 Device Name encoding (extract from the PROFINET Specification IEC 61158-6-10 & 4.3.1.4.15.2)

The Device Name respecting these rules can be read or written in EPack by using the PROFINET tool (e.g. with the TIA Portal/STEP 7).

Display of the Device Name on the EPack screen

The display of EPack allows the last eleven characters to be displayed (see [Figure 47](#)).

However, if the length of the “Device Name” is greater than eleven, the full “Device Name” is displayed by scrolling.

NOTE: If the length is greater than 64, only the last 61 characters are displayed followed by three dots.

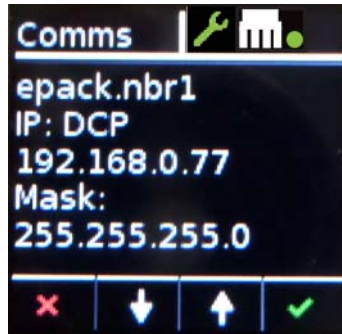

Figure 47 Display of the Device Name on EPack (e.g. “epack.nbr1”).

Display of the Device Name in iTools

The last 64 characters of the Device Name are displayed in iTools in the ‘Comms Functional Block’ through the ‘PN_DevName’ parameter (read only).

Other DCP Services

In addition to the assignment of the ‘Device Name’ and the ‘IP Configuration’, the DCP protocol provides the following services for EPack.

Flash LED (also called “Flash Once”)

The DCP service provides easy visual identification of a Device among a group of Devices.

For this, the Ethernet LEDs and the EPack display (blink by inverted colour) flash with a duration of 3 seconds and a frequency of 1 Hz (500 ms on, 500 ms off).

Reset to factory

The DCP service allows the IP Configuration to be reset (reset to 0) and the Device Name (reset to “”) to its as-delivered condition, the device returns to its state shown in [Figure 45](#).

Cyclic Data Exchange (PROFINET IO Data)

Since E-Pack contains a great number of parameters, the user can select the more relevant input and output parameters and bring them into the "Fieldbus I/O Gateway".

The procedure to setup E-Pack parameters into the "Fieldbus I/O Gateway" is detailed in Chapter 8.5.

The "Fieldbus I/O Gateway" can contain up to 16 output registers (32 bytes as E-Pack uses the Modbus format of 2 Bytes) and up to 32 input registers (64 bytes).

By default, the most frequently used values are included, but it is possible to select other parameters within the unit.

The cyclic I/O data are transmitted unacknowledged between the provider and consumer as real-time data at parameterisable increments (send cycle).

NOTE: The same principle is used for the Ethernet/IP Cyclic Exchanges as described in Chapter 5.1.8.

Hence, two PROFINET I/O Modules have been defined to access to the inputs and to the outputs of the "Fieldbus I/O Gateway":

- "One Input module of 64 Bytes for addressing the 32 input "I/O Gateway" registers
- "One Output module of 32 Bytes for addressing the 16 output "I/O Gateway" registers

These modules are defined in the GSDML file.

Configuring the Cyclic (IO Data) Data Exchange

During the PROFINET commissioning, the principle is to 'plug' the first module (representing the "Input I/O Gateway") into the slot 1 and the second one (representing the "Output I/O Gateway") into the slot 2 (at this stage, it is assumed that the 'Device Name' and the 'IP Configuration' has already been set up).

This operation is performed with the PROFINET configuration tool based on the GSDML file (e.g. with the TIA Portal/STEP 7, see Figures 48 and Figures 49 below).

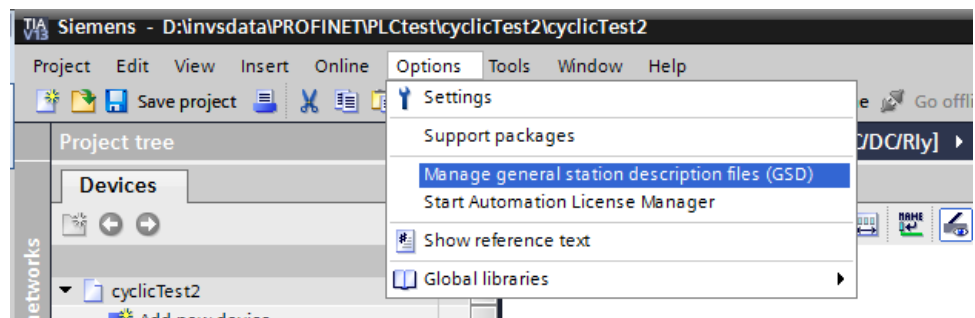

Figure 48 Loading the E-Pack GSDML file into STEP7

Figures 49 below shows "Drag and Drop" of the Input and Output Modules (Input and Output I/O Gateway image) respectively into Slot 1 and Slot 2 of EPack.

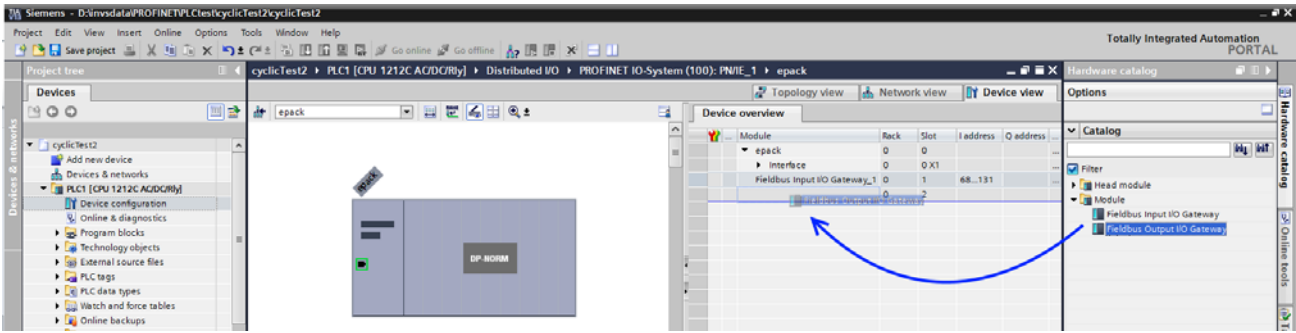

Figure 49 "Drag and Drop" I/O Modules

Once this has been completed, compile the configuration and download it to the IO Controller (PLC). The cyclic exchanges will then start with the IO Device, so with EPack (see Figures 50 below).

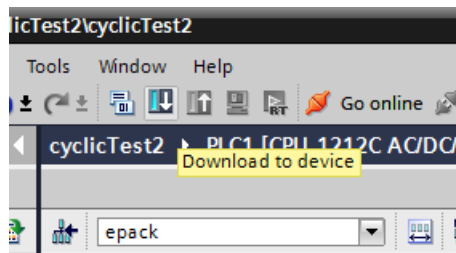

Figure 50 The compiled configuration is downloaded to EPack

NOTE: The IO cycle can be adjusted to 16 ms (by default) up to 512 ms.

Acyclic Data Exchange (Record Data)

Acyclic data exchange (or Record Data) is used to transfer data that does not require continuous updates.

It is possible to access any parameter in the EPack controller unit by this means, regardless of whether it has been included in the PROFINET input/output data assembly.

Acyclic data are transmitted via UDP/IP with the RPC protocol. For this, PROFINET provides "Read" and "Write" services of data.

For addressing Record Data services, the combination of API/Slot/Subslot/Index values is used.

The Modbus address of the EPack parameter to read or write is passed through the Index value.

Modbus addresses are listed in the iTools Parameter Explorer.

PROFINET Acyclic Readings

This section describes how to access a variable using PROFINET in acyclic mode.

PROFINET uses the following parameter to access a variable in acyclic mode:

- "API
- "The Slot and Subslot
- Index

To access a parameter in acyclic mode, you first need to know its Modbus address. This may be accessed by selecting the parameter from the Parameter Explorer list shown in Address column.

The figure below shows an alternative way to access a parameter. This uses the Graphical wiring editor. The Modbus address is shown in Address column. Right click on the parameter to open the parameter help window

Right click on the parameter to open the parameter help window.

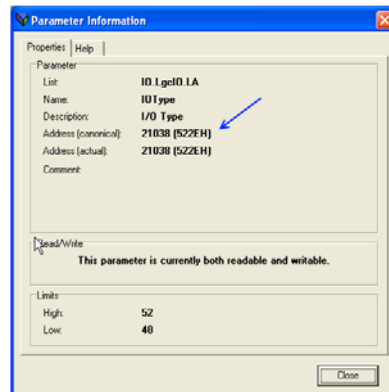

Figure 51 Parameter Access using the Graphical Wiring Editor

From this address, use the following conversion to get the PROFINET way of addressing a parameter:

- "The API is always 0 (Zero)
- "The Slot is always 1 (One)
- "The Subslot is always 1 (One)
- "The Index will be the Modbus-address you found previously in iTools

Constraints on the Parameters

The parameter in acyclic-mode follows the same limitation as the parameters in the Fieldbus I/O gateway: 16 bits length and they follow the same scaling, see [Cyclic Data Exchange \(PROFINET IO Data\) \(page 83\)](#).

Data Formats

Data is returned as 'scaled integers', such that 999.9 is returned or sent as 9999; 12.34 is encoded as 1234. The control program in the PROFINET master must convert the numbers into floating point values if required.

The GSD File

The PROFINET GSDML (General Stations Description) file for EPack controller has the generic name GSDML-V[GsdVersion?]-Eurotherm-EPack-[dateOfCreation].xml and is available from your supplier, or electronically by going to Web site www.eurotherm.co.uk.

It will also be available where the upgrade tool has been installed (for example, in C:\Program Files(x86)\EPack_V#.##).

The GSD file is designed to automate the PROFINET network configuration process by precisely defining the required device parameter information. Software configuration tools utilise the GSD file to configure an PROFINET network.

Alarm Notification

EPack has the ability to send "Alarm Notification" when an alarm is raised; the I/O Controller acknowledges this Alarm Notification request (e.g. "Missing Mains Indication" when the Mains [power supply] is off).

The Alarms are 'hooked' to the "Input I/O Module" (connected to the Slot 1).

The Alarm ID is passed through the Extended Diagnosis value (32 bit format in two Words detailed below)

Alarm Status Word 1 (LSB)	
Bit	Alarm Origin
0	Missing Mains Indication
1	Thyristor Short Circuit Indication
2	Over Temperature Indication
3	Networks dips Indication
4	Frequency fault Indication
5	Total Load Failure Indication
6	Chop-Off Indication
7	PLF Indication
8	Reserved for PLU
9	Over Voltage Indication
10	Under Voltage Indication
11	Pre-Temperature Indication
12	Over Current Indication
13	Reserved
14	Analogue IP Over Current Indication
15	External Input Indication

Alarm Status Word 2 (MSB)	
Bit	Alarm Origin
0	Closed Loop Indication
1	Transfer Active
2	Limitation Active
3	Reserved for PLM
4 .. 7	Reserved
8	Any bit in Global Status 0
9	Any bit in Global Status 1
10	Any bit in Global Status 2
11	Any bit in Global Status 3
12 .. 15	Reserved

Configuration from the Front Panel

At power up or after quitting the Quickcode menu, the unit initialises and then enters the summary page (figure 52) showing the real-time values of the two parameters configured, see [Instrument Display configuration](#) for details.

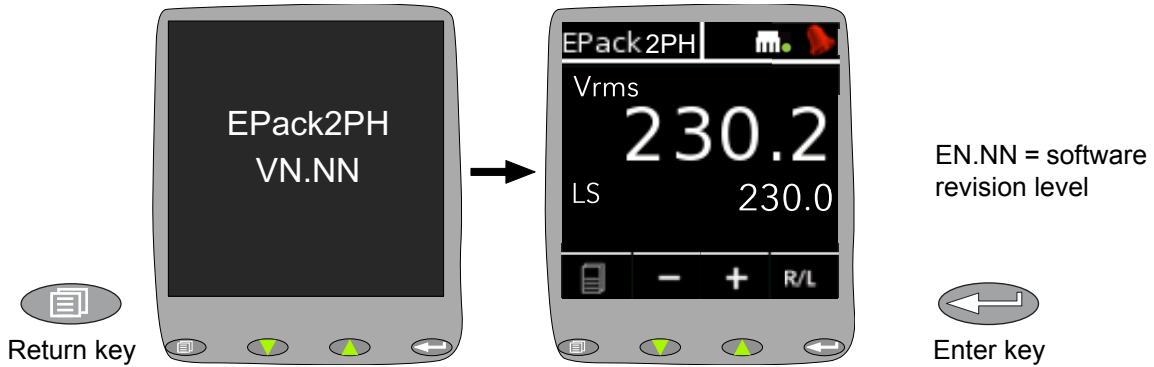

Figure 52 Initialisation screens

NOTE: If any faults are detected during initialisation (e.g. supply voltage missing), then error messages appear on the display screen.

Menu Pages

Operating the return key opens the first page of the menu, the content of which depends on the current access level and on the number of options enabled.

The descriptions below assume either 'Configuration' or 'Engineer' level access.

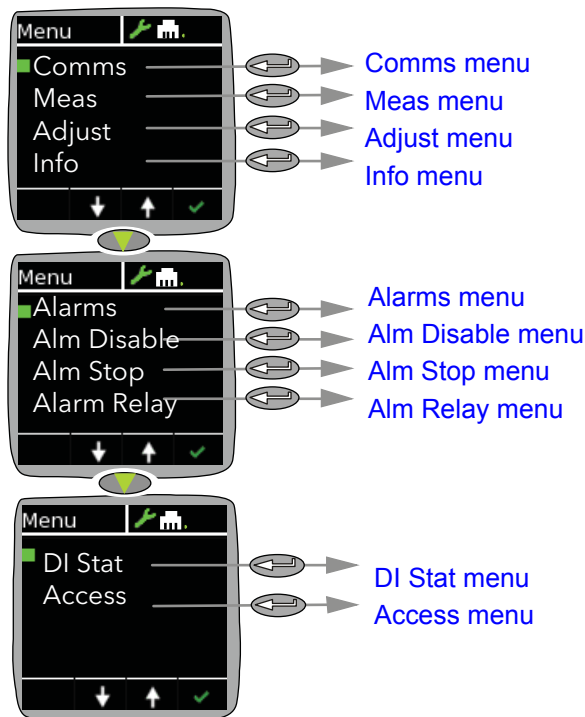

Figure 53 Menu options

Comms menu

This allows the following communications parameters to be viewed or configured. In Engineer mode the Comms menu is read-only.

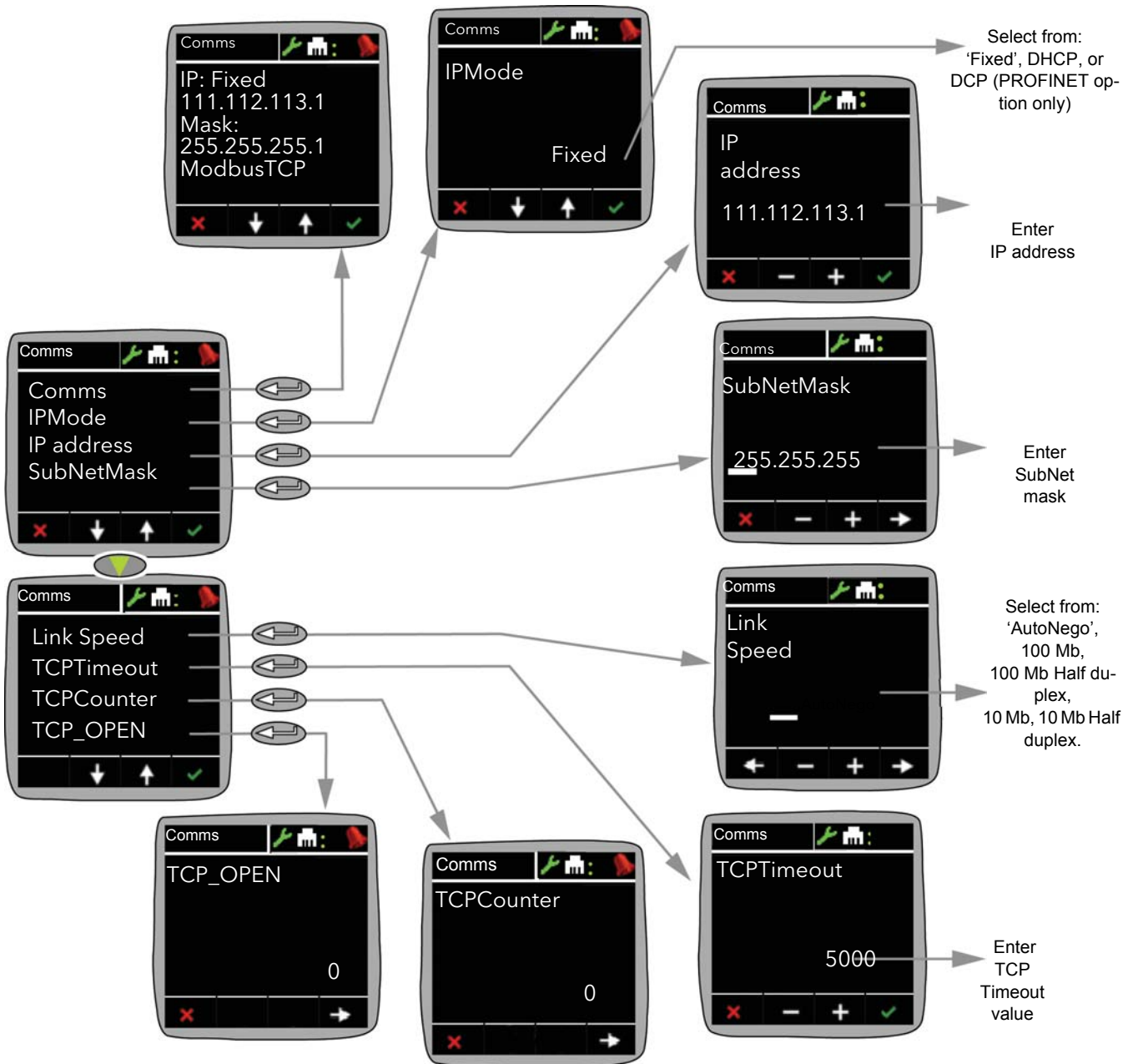

Figure 54 Comms menu

Comms
IP Mode

Displays (read only) the current IP and Subnet mask addresses. Allows the user to select 'Fixed', 'DHCP' or 'DCP' as the IP address source. If 'Fixed' is selected, then the IP address and Subnet Mask can be edited in the following fields. It must be ensured that the address is unique to the network. If DHCP ('Dynamic Host Configuration Protocol') is selected, the IP Address and SubNetMask parameters described below do not appear. DHCP will be successful only if there is a suitable DHCP server on the network to which the unit is connected. DCP ('Discovery and Configuration Protocol') is only used with the PROFINET protocol.

IP Address	Appears only if 'Fixed' is selected as IP Mode (above). Allows the user to edit the current IP address. Example: To set an IP address of 111.112.113.1, use the up and down arrow pushbuttons to set the first section of the address to 111. Use the enter key, and then the up and down pushbuttons to set the second section to 112. Use the enter key, and then the up and down pushbuttons to set the third section to 113. Use the enter key, and then the up and down pushbuttons to set the fourth section to 1 (not 01 or 001). Use the Enter key to quit Edit mode. If any section is already as required, it can be skipped by using the Enter key.
SubNetMask	Set the subNet mask as described above for the IP address.
Link Speed	Select the required link type and speed.
TCPTimeout	Is used to set the timeout period, (measured in milliseconds) that is used to close any open TCP connections not being used by the master, which originally opened the connection. Adjust in Configuration mode. The default value is 5000 ms.
TCPCounter	TCPCounter records and displays the number of times EPack resets itself. (A reset takes place if the threshold of detected open connections is exceeded. EPack automatically resets itself).
TCP_Open	TCP Open displays the quantity of live, open connections. NOTE: For details about subnet masks, see (iTools wiring).

Meas menu

This menu allows the user to view a number of measured values in real time. For further details, see 'Network Meas Menu' (see page 147).

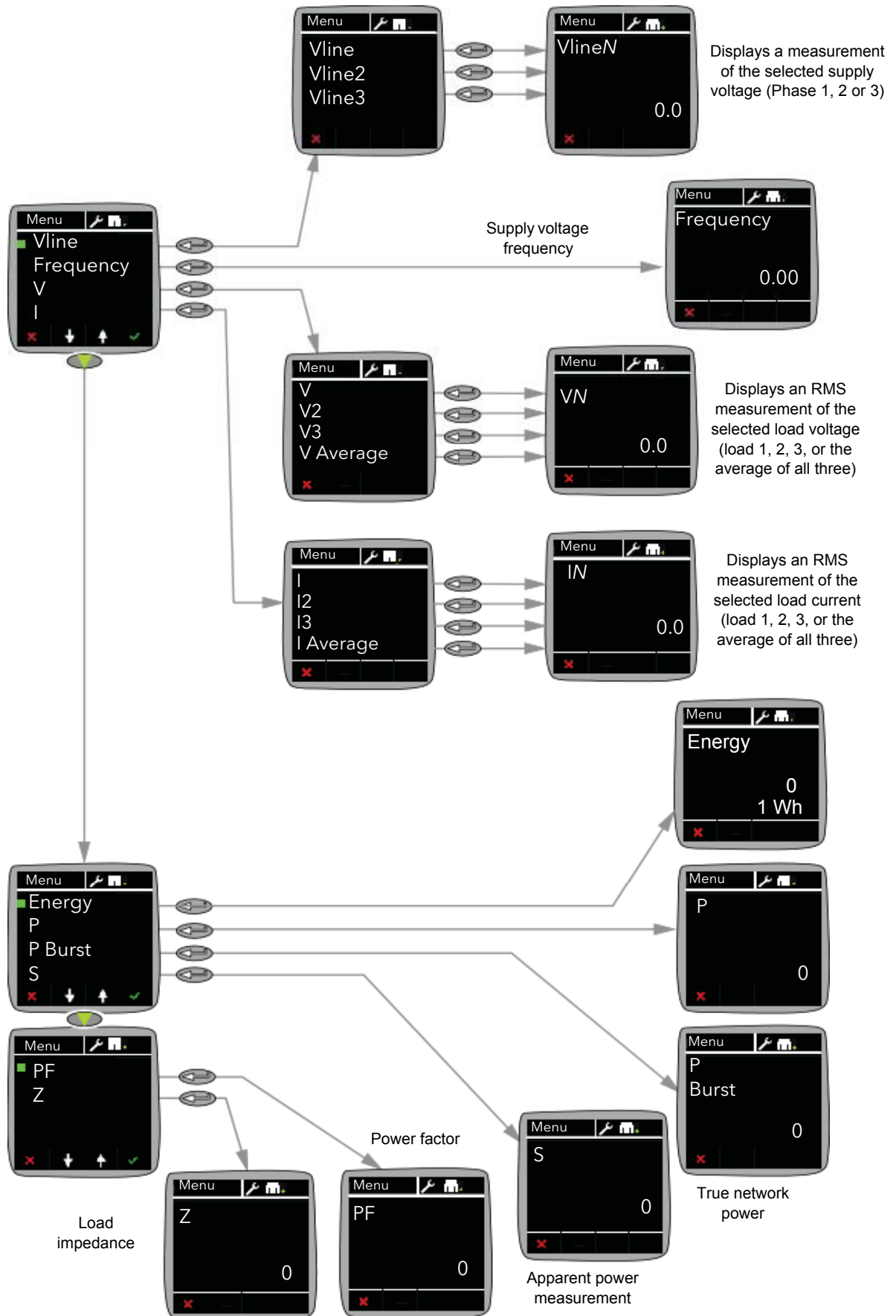

Figure 55 Meas menu

Adjust menu

This menu allows a number of network and firing output parameters to be set up, as well as Analogue input type.

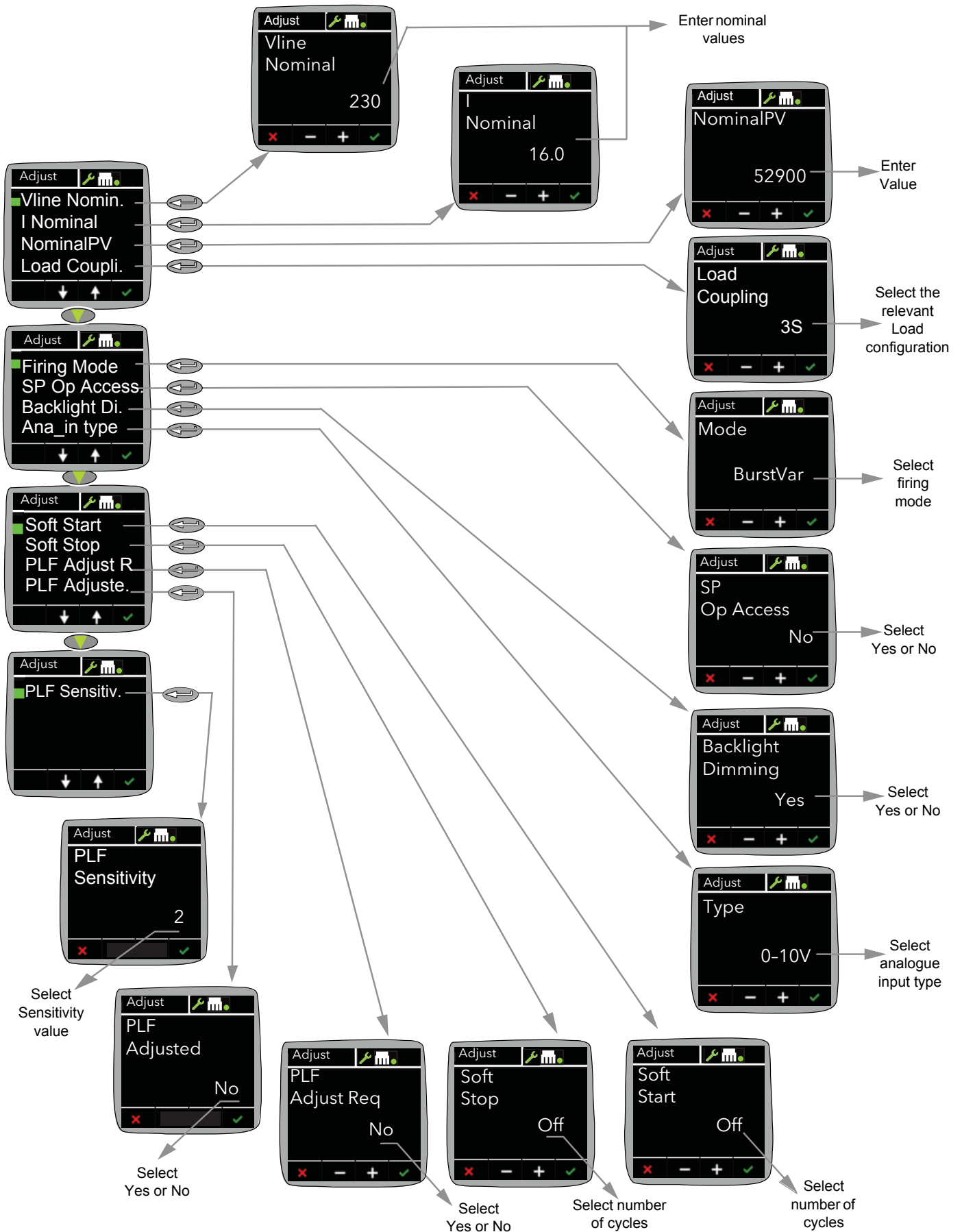

Figure 56 Adjust menu

Vline Nominal	Line voltage nominal value (Line to neutral)
I Nominal	Nominal current supplied to the load
NominalPV	Nominal Process Variable. Defines the nominal value for each control type. For example, for Vsq control, you must wire Vsq from the network block to the MainPV and set NominalPV to the nominal value you expect for Vsq—typically this could be Vload-Nominal*VloadNominal.
Load Coupling	Allows you to specify how the load is configured on your installation. Select between 3S (star without neutral), 3D (closed delta), 4S (star with neutral), and 6D (open delta). See Load Configurations (page 34) for more details.
Firing Mode	Firing Mode. Allows the firing mode to be selected as Burst Var, Burst Fix, Logic, Phase Angle (PA) or Intelligent half cycle (IHC). See Firing Output Menu (page 127) for more details.
SP Op Access	Setpoint Operator Access: Allows the user setpoint access via the front panel, in operator configuration when enabled. To enable set to Yes. (The default setting is Yes).
Backlight Di.	Backlight Dimming: By default, the backlight on the EPack's display dims automatically to save power. Set this parameter to No if you want the backlight to always remain on. If set to Yes, the backlight dims 30 seconds after you last operate the buttons on the front panel.
Ana_in type	Select the Analogue Input type as 0 to 10V, 1 to 5 V, 2 to 10V, 0 to 5V, 0 to 20mA,4 to 20mA.
Soft Start	For Burst Firing only, this is the soft start duration, in supply voltage cycles, applying a phase angle ramp at the beginning of each on period. See Firing Output Menu (page 127) for more details.
Soft Stop	In Burst Firing, the soft stop duration, in supply voltage cycles, applying a phase angle ramp at the end of each on period. See Firing Output Menu (page 127) for more details.
PLF Adjust R	Partial Load Failure Adjustment Request: When the process has achieved a steady state condition the operator must set the PLF-AdjustReq. This makes a load impedance measurement to be used as a reference for detecting a partial load failure. If the load impedance measurement is successful 'PLFAdjusted' is set. The measurement fails if the load voltage (V) is below 30% of VNominal or if the current (I) is below 30% of INominal. The input is edge sensitive, so if the request is made from external wiring, and the input remains permanently at a high level, only the first 0 to 1edge is taken into account.
PLF Adjusted	Partial Load Failure Adjusted: A successful load impedance measurement has been made (see PLF Adjust R above).
PLF Sensitivity	Partial load failure sensitivity. This defines how sensitive the partial load failure detection is to be as the ratio between the load impedance for a PLFadjusted load and the current impedance measurement. For example for a load of N parallel, identical elements, if the PLF Sensitivity (s) is set to 2, then a PLF alarm will occur if N/2, or more elements are broken (i.e. open circuit). If PLF Sensitivity is set to 3, then a PLF alarm occurs if N/3 or more elements are broken. If (N/s) is non-integer, then the sensitivity is rounded up. E.G. if the N = 6 and s= 4, then the alarm is triggered if 2 or more elements are broken.

Info menu

This display gives read only information about the unit.

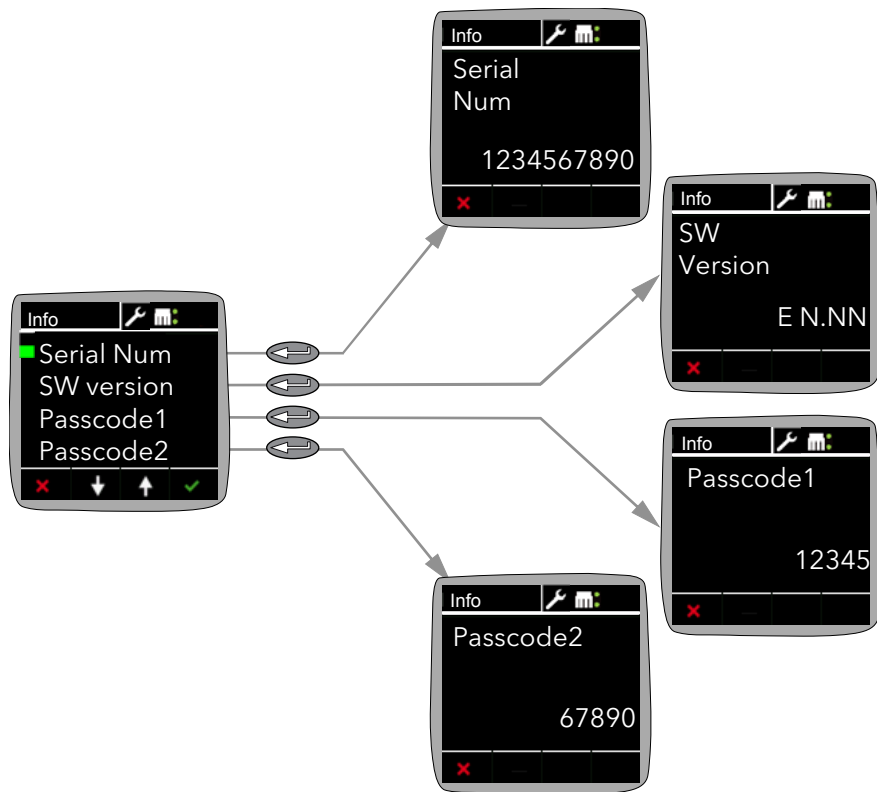

Figure 57 Info menu

Strat menu

The Strat menu is only available in Engineer mode. It allows the user to view a number of control strategy parameters in real time.

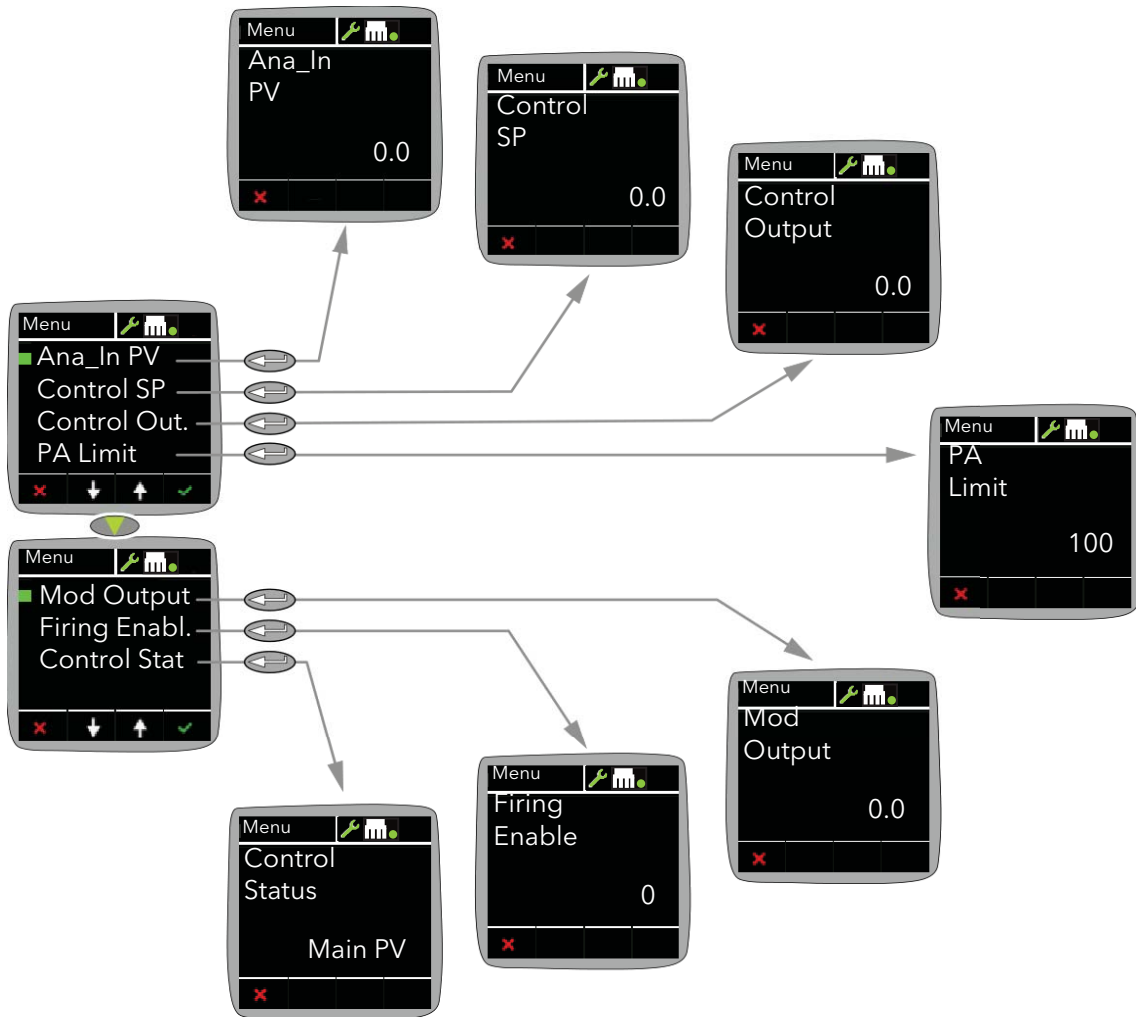

Figure 58 Strat menu

Ana_In PV	The scaled value in process units of the analogue input. Clipped to the Range High or Range Low value if the signal goes over range or under range respectively, (see page 130).
Control SP	The Setpoint to control at, as a percentage of Nominal PV, (see page 115).
Control Out.	The instantaneous control output demand in percent, (see page 117).
PA Limit	Phase angle limit. This is a phase angle reduction output demand used in Burst Firing. If lower than 100% the power module delivers a burst of phase angle firing. Used, typically, to perform threshold current limiting in Burst Firing, (see page 127).
Mod Output	The output logic signal controlling the power module on and off times, normally wired to the input of the firing block. For Mode = Phase angle, this is a phase angle demand, (see page 145).
Firing Enabl.	Enables/disables firing. Must be wired to a non-zero value to enable firing, (see page 127).
Control Stat (see page 117)	Indicates the current operating state of the controller:
Main PV	The control strategy is using Main PV as the control input
Transfr	The transfer input is being used as the input to the control strategy.
	Limit1(2)(3)Control limiting is currently active using limit PV1(2)(3) and limit SP 1(2)(3).

PLF menu

The PLF (Partial Load Failure) menu is only available in Engineer mode.

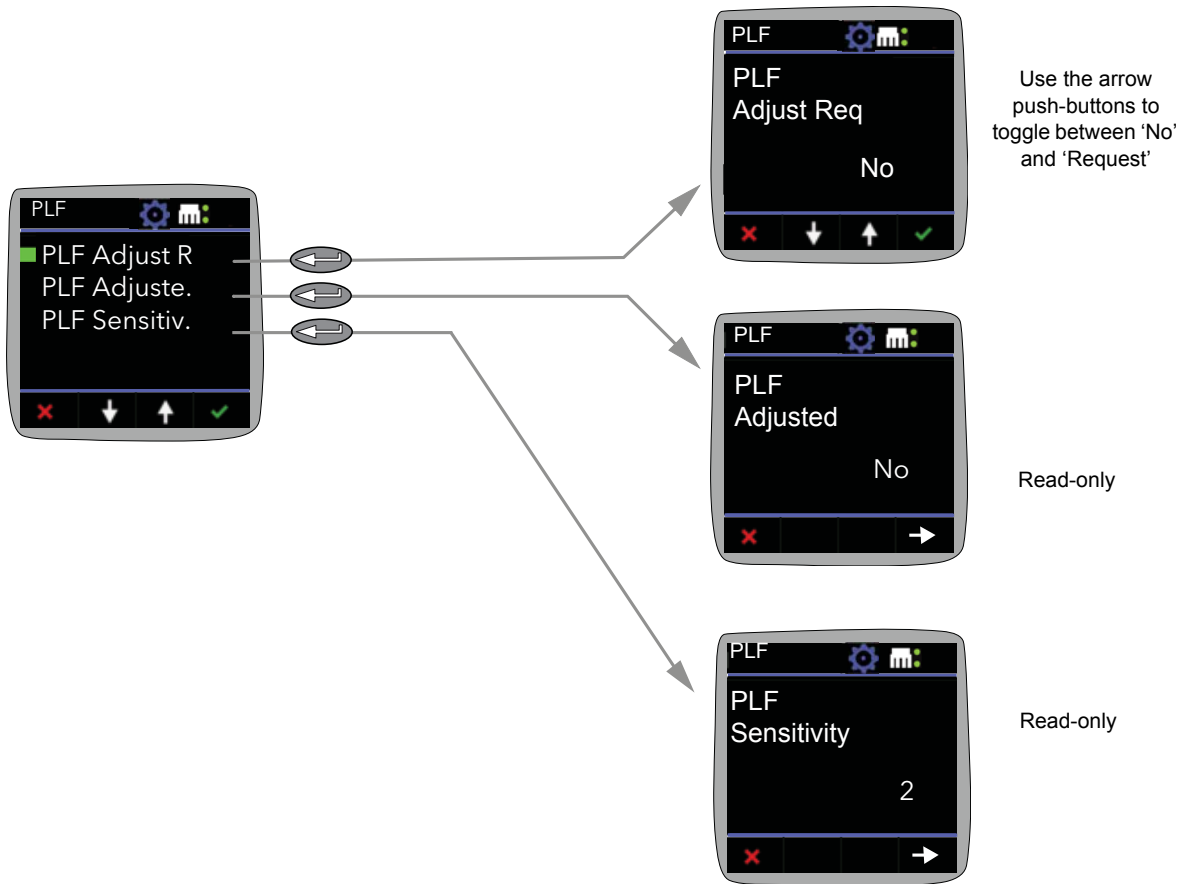

Figure 59 PLF menu

PLF Adjust R

Partial Load Failure Adjustment Request: When the process has achieved a steady state condition the operator must set the PLF-AdjustReq. This makes a load impedance measurement to be used as a reference for detecting a partial load failure. If the load impedance measurement is successful 'PLFAdjusted' is set. The measurement fails if the load voltage (V) is below 30% of VNominal or if the current (I) is below 30% of INominal. The input is edge sensitive, so if the request is made from external wiring, and the input remains permanently at a high level, only the first 0 to 1 edge is taken into account.

PLF Adjusted

Partial Load Failure Adjusted: Reports whether a successful load impedance measurement has been made (see PLF Adjust R above).

PLF Sensitivity

Partial load failure sensitivity. This defines how sensitive the partial load failure detection is to be as the ratio between the load impedance for a PLFadjusted load and the current impedance measurement. For example for a load of N parallel, identical elements, if the PLF Sensitivity (s) is set to 2, then a PLF alarm will occur if N/2, or more elements are broken (i.e. open circuit). If PLF Sensitivity is set to 3, then a PLF alarm occurs if N/3 or more elements are broken. If (N/s) is non-integer, then the sensitivity is rounded up. E.G. if the N = 6 and s= 4, then the alarm is triggered if 2 or more elements are broken.

Settings menu

The Settings menu is only available in Engineer mode. This menu is read-only, and lets you view the values of the parameters described below.

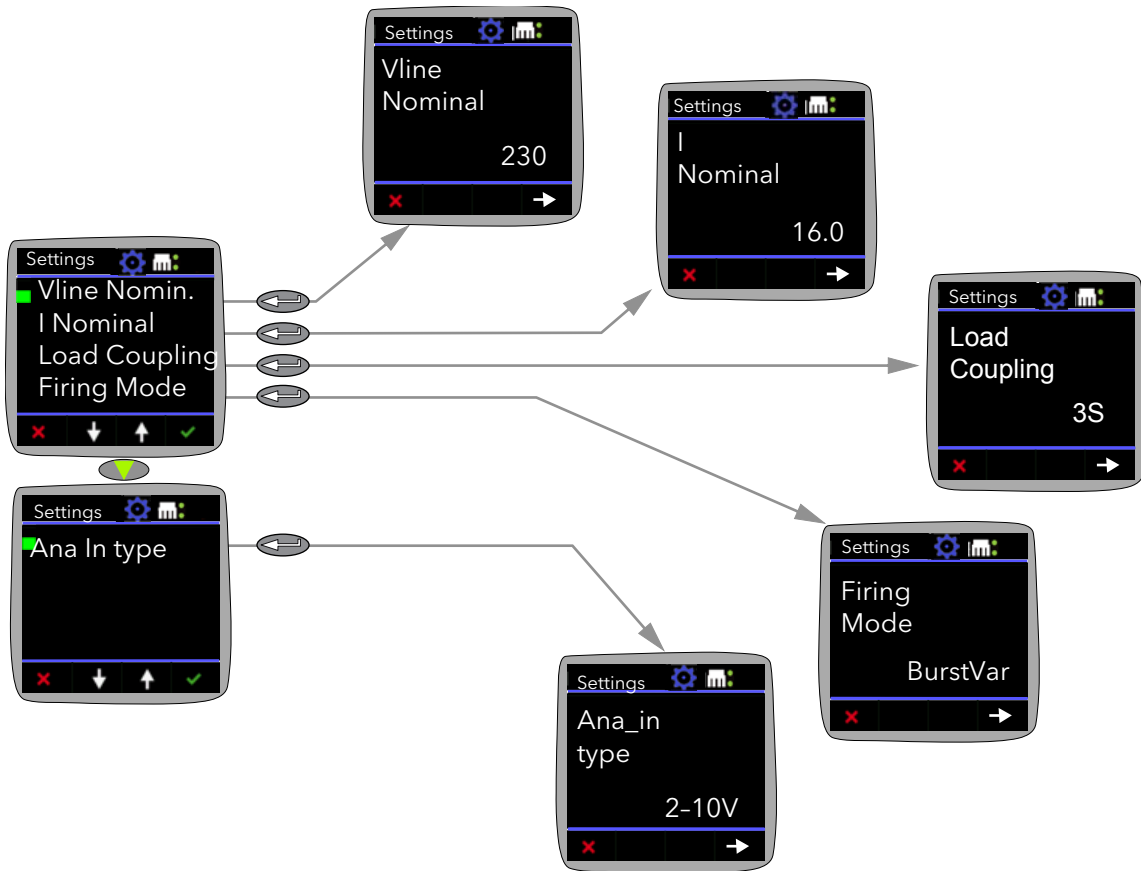

Figure 60 Settings menu

<p>Vline Nominal</p> <p>I Nominal</p> <p>NominalPV</p>	<p>Line voltage nominal value (Line to neutral)</p> <p>Nominal current supplied to the load</p> <p>Nominal Process Variable. Reports the nominal value for each control type. For example, for Vs_q control, you must wire Vs_q from the network block to the MainPV and set NominalPV to the nominal value you expect for Vs_q—typically this could be Vload-Nominal*VloadNominal.</p>
<p>Load Coupling</p>	<p>Displays the current load configuration type. For diagrams of these configurations, see Load Configurations (page 34).</p>
<p>Firing Mode</p>	<p>Reports the firing mode: Burst Var, Burst Fix, Logic, Phase Angle (PA) or Intelligent half cycle (IHC).</p>
<p>Ana_in type</p>	<p>Reports the Analogue Input type: 0 to 10V, 1 to 5 V, 2 to 10V, 0 to 5V, 0 to 20mA, or 4 to 20mA.</p>

Alarms menu

Allows the user to view Global acknowledgement enable status. Any active alarms appear, and details can be found by selecting the relevant alarm and using the Enter push button.

Active alarms can be acknowledged, if applicable, by a further operation of the Enter button.

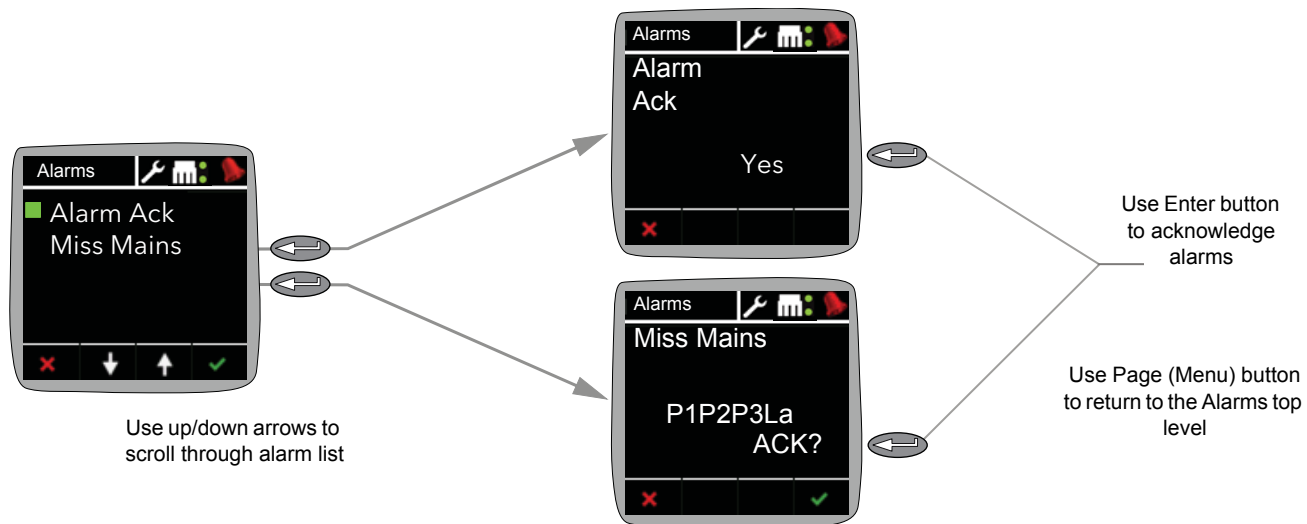

Figure 61 Alarms menu

Alm Disable menu

This menu allows the user to disable particular alarm types, so that they are no longer detected or acted upon. You can also do this using iTools.

By default all of the alarms are enabled.

To disable or re-enable an alarm, simply scroll through the list and select the alarm you want, then use the arrow keys to toggle its status between Disable and Enable as required.

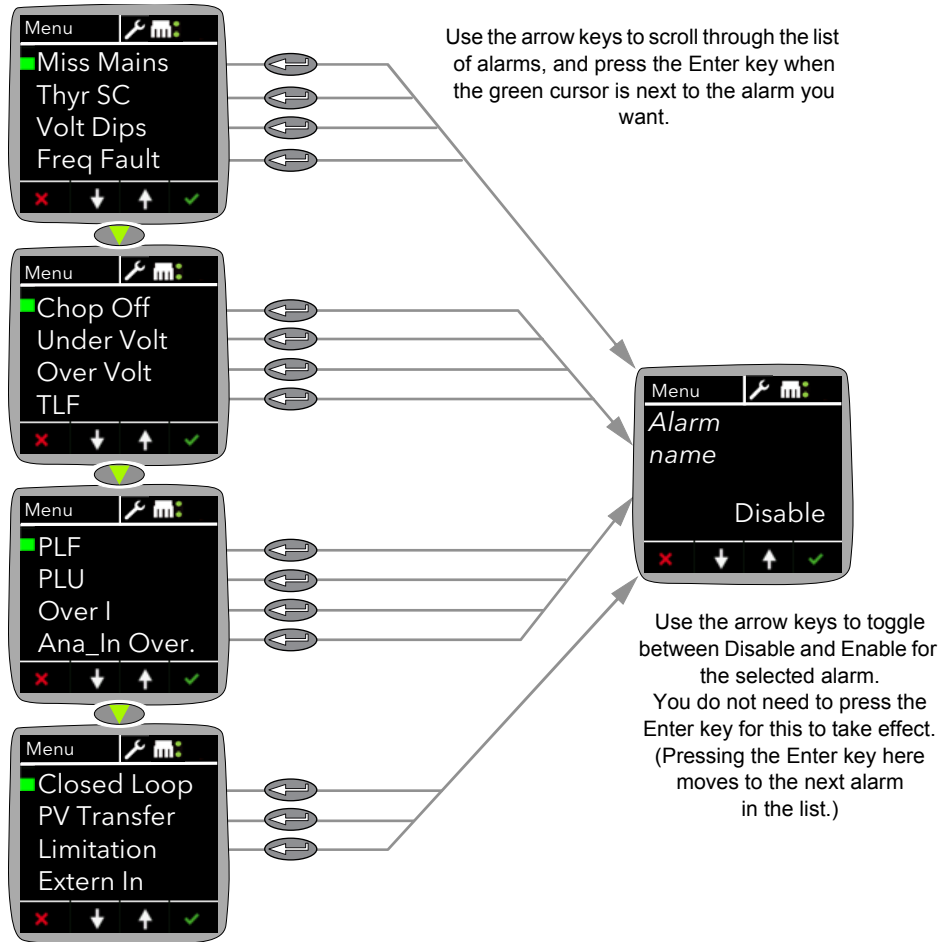

Figure 62 Alarm Disable menu

Alm Stop menu

This menu allows the user to set which alarms will cause the EPack to stop firing. You can also do this using iTools.

By default, non of the alarms are set to stop firing.

To change whether an alarm causes the EPack to stop firing, simply scroll through the list and select the alarm you want, then use the arrow keys to toggle its status between Stop and NoStop as required.

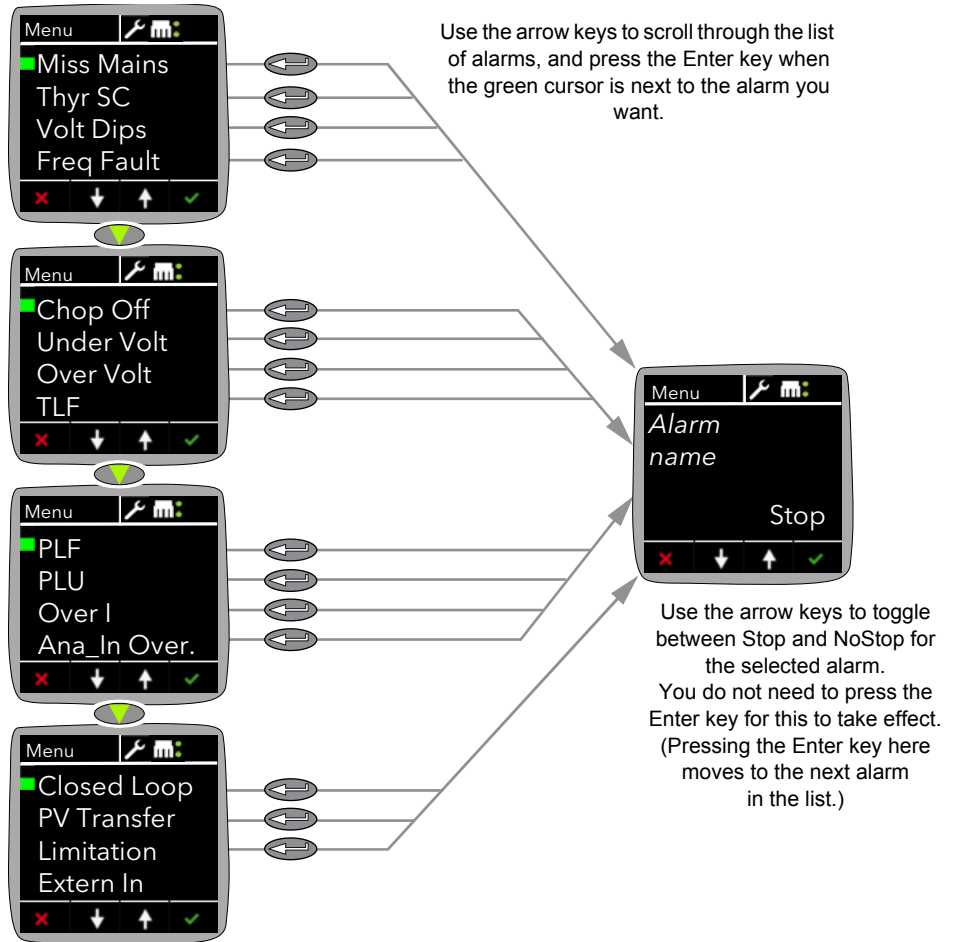

Figure 63 Alarm Disable menu

Alm Relay menu

This menu allows the user to select which alarms are to operate (de-energise) the EPack's 'watchdog' relay. For each selected alarm, select 'Yes' or 'No'.

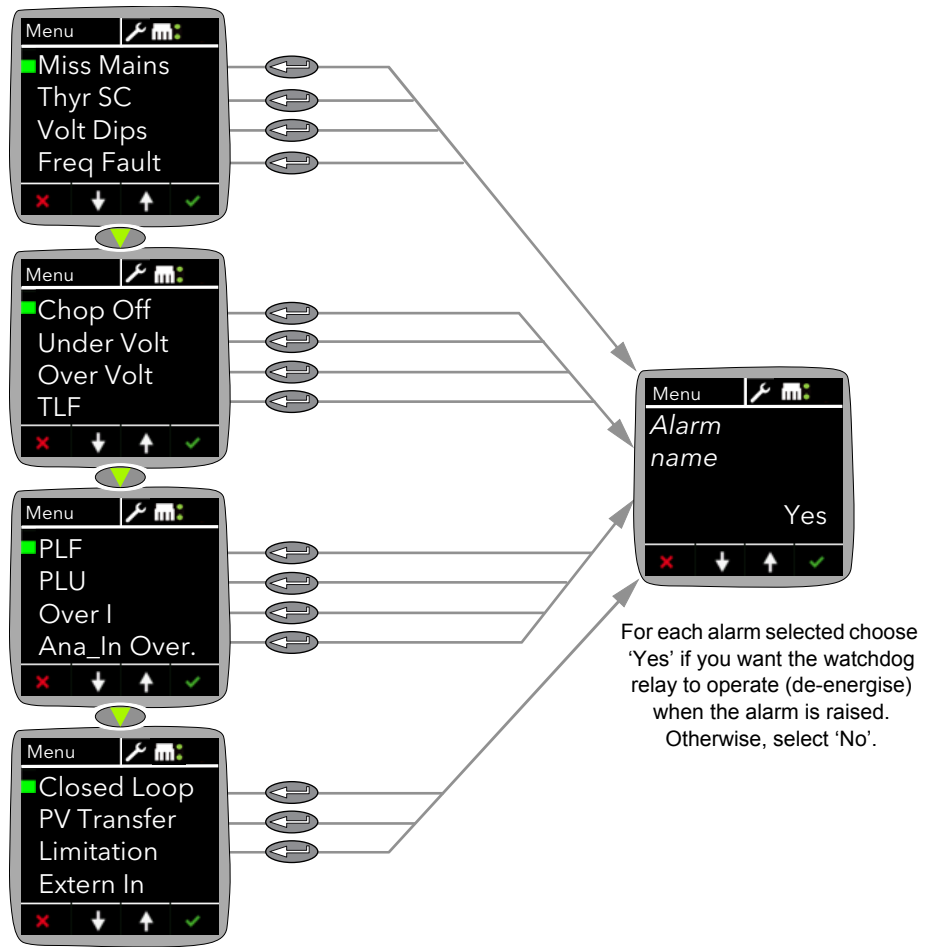

Figure 64 Alm relay menu

DI Stat menu

The DI Stat menu displays the status of the EPack's two digital inputs, DI1 and DI2.

'0' means a low level logic signal is being received at the input, '1' means a high level logic signal is being received at the input.

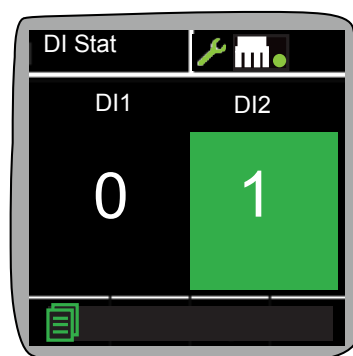

Figure 65 DI Stat menu

Access menu

Allows access to the Operator, Engineer, Configuration, Quick Code and OEM menus and allows passwords to be set up.

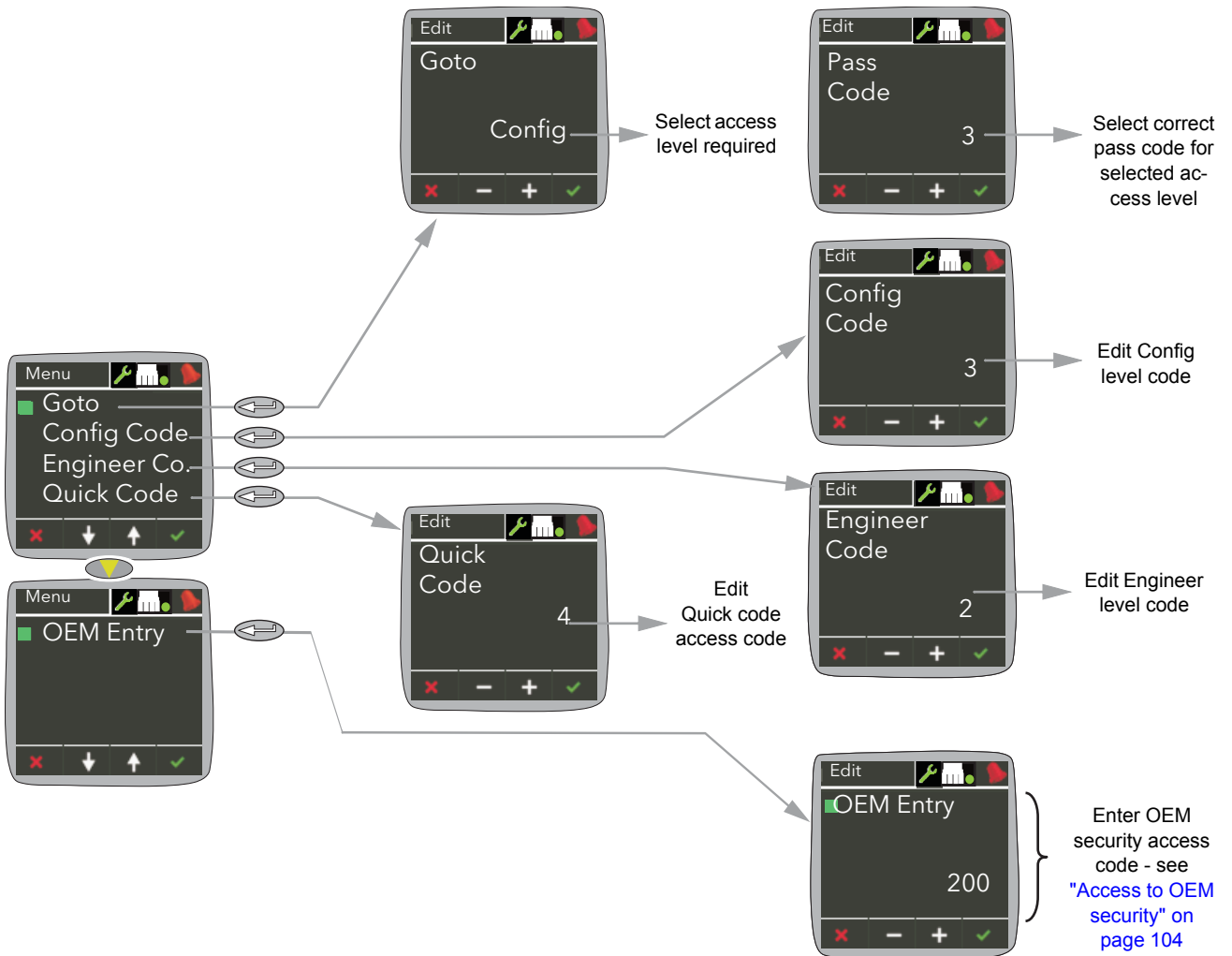

Figure 66 Access menu

- Goto Allows access level to be selected.
- Pass Code Allows the user to enter the code for the access level required.
- Config Code Allows the user to edit the Configuration access level code
- Engineer Code Allows the user to edit the Engineer access level code
- Quick Code Allows the user to edit the Quick code access code
- OEM Entry¹ Allows the user to enter the OEM security access code required to display and access the remaining OEM security menus (see "Access to OEM security" on page 104).

NOTE: The default access codes are Operator = 0, Engineer = 2, Config = 3, Quickcode = 4, OEM Entry = 200.

1. The menu OEM Entry, is part of the OEM security feature which is a chargeable option.

Access to Menus

1. Open the Access menu item.
2. Open the Goto menu item and select the access level required.
3. Enter the access code for the level required. If this access code is correct the relevant menu appears.

NOTE: The above applies only when the user attempts to access a higher level than that current. If accessing a lower level, the user needs only to open the Goto item and select the required level. After doing this, the instrument will probably restart.

Access to OEM security

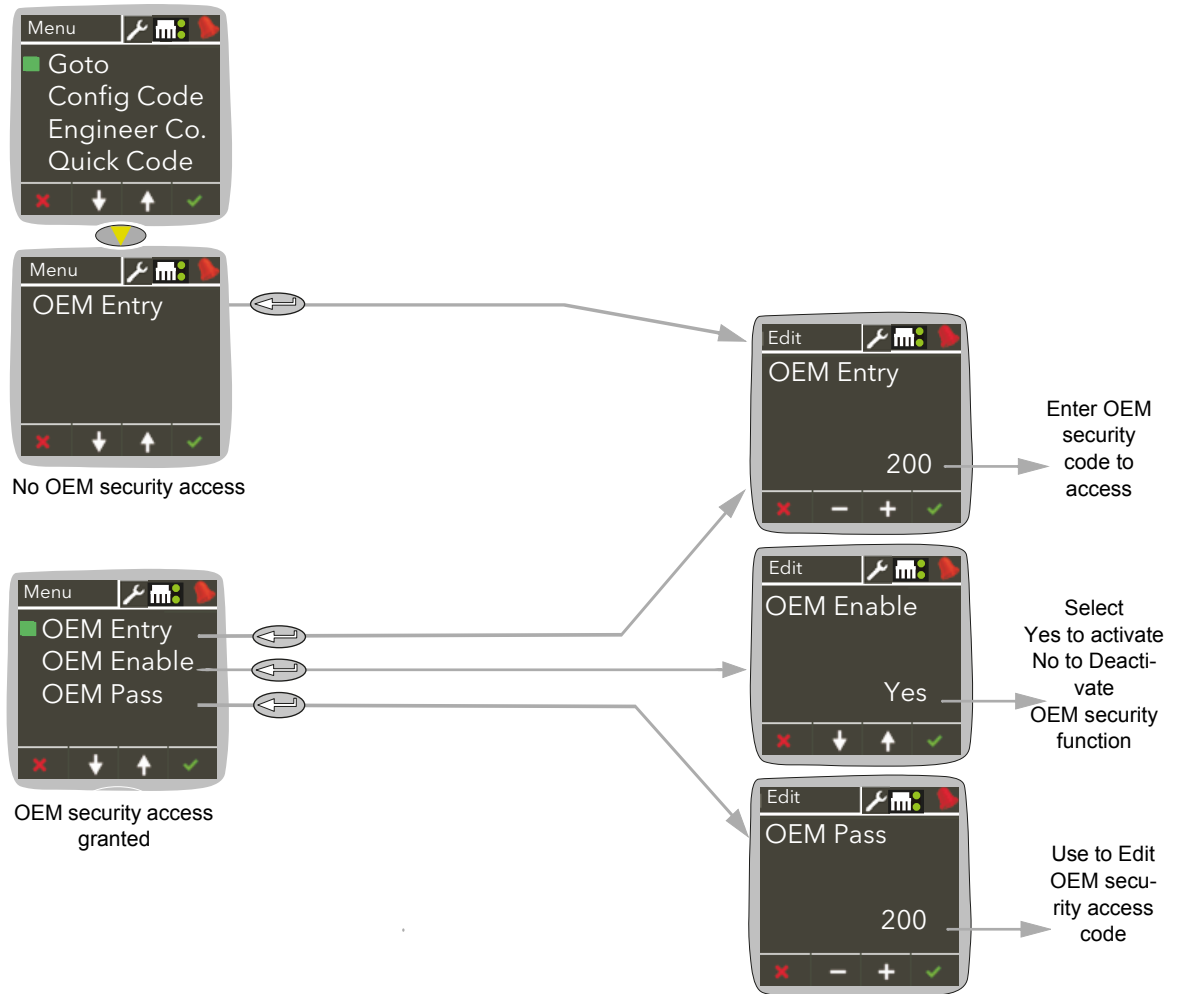

Figure 67 Access, OEM security menus

- OEM Enable¹ Allows the user to enable or disable OEM security feature.
- OEM Pass¹ Allows the user to edit the OEM security access code.

To access OEM security:

1. Open the Access menu item.
2. Select and open the OEM Entry menu item.
3. Enter the OEM security access code (default: 200).

1. Menu appears once the OEM security pass code is entered and matches OEM Pass value, using the OEM Entry menu.

4. The OEM Enable menu automatically appears, exit the menu by pressing the **x** button.

Note: To enable, start OEM security, select 'Yes'; to disable the feature, select 'No'.

5. The Access menu item returns and will have two additional menu options: OEM Enable and OEM Pass.

Configuration using iTools

Introduction

NOTE: This chapter contains descriptions of all the menus which can appear. If an option or a feature is not fitted and/or enabled, then it does not appear in the top level menu.

This chapter details how to connect using iTools and gives details of the features available from this instrument.

Overview

The configuration of the unit is divided into a number of separate areas as follows:

- "Access Menu" on page 107
- "Alarm Configuration" on page 109
- "Communications Configuration" on page 110
- "Control Configuration" on page 113
- "Counter Configuration" on page 121
- "Energy Configuration" on page 123
- "Fault Detection Menu" on page 125
- "Firing Output Menu" on page 127
- "Input/Output (IO) Configuration" on page 129
- "Instrument Configuration Menu" on page 134
- "IP Monitor Configuration" on page 138
- "Lgc2 (Two Input Logic Operator) Menu" on page 139
- "Lgc8 (Eight-input Logic Operator) Configuration" on page 141
- "Math2 Menu" on page 143
- "Modulator Configuration" on page 145
- "Network Configuration" on page 146
- "Qcode" on page 153
- "Setprov Configuration Menu" on page 155
- "Timer Configuration" on page 157
- "Totaliser Configuration" on page 159
- "User Value Configuration Menu" on page 160

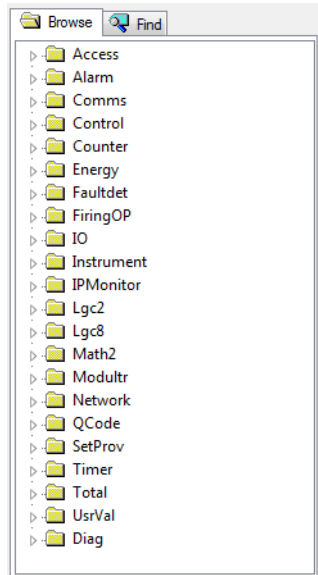

Figure 68 iTools tree

NOTE: Current rating, limitation, transfer control, power control, energy counter and the graphical wiring editor (GWE) are chargeable options. iTools secure can be used to upgrade units.

Access Menu

The Access menu allows the user to set the operating level (Operator, Engineer, Configuration or QuickStart) and define the access codes for these levels. In addition, the Access menu allows the configuration of the optional OEM Security feature.

OEM security provides users, typically OEMs (original equipment manufacturers) the ability to protect their intellectual property by preventing unauthorised access to configuration data.

An OEM security access code can be configured to prevent iTools from fully communicating with the instrument, preventing specific parameters and their associated values from being copied or over written during iTools clone export/import.

In addition, when the OEM security feature is enabled, iTools has restricted access to Modbus addresses between 0x100 and 0x4744, graphical wiring and software upgrade functionality.

NOTE: The OEM security feature is a chargeable option, either when ordering or via the purchase of a secure feature pass code.

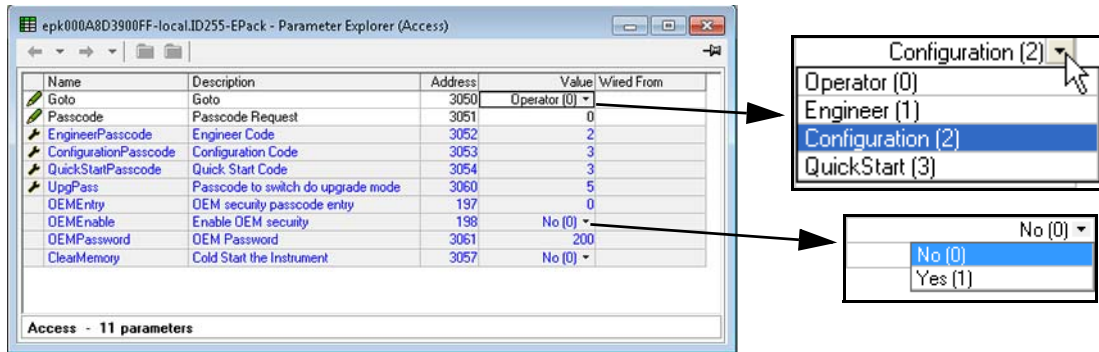

Figure 69 iTools Access menu

- Goto Select access level
- Passcode Select relevant pass code for the access level required.
- EngineerPasscode Passcode for Engineer level access
- ConfigurationPasscode Passcode for Configuration level access
- QuickStartPasscod Passcode for Quickcode menu
Quickcode remains available from the E-Pack menu, when run successfully the default setting disables the OEM security feature.
- UPGPass Passcode for upgrading device
- OEMEntry Passcode for OEM security access.
Provided the user enters the correct passcode, the OEM security feature will load and display the remaining OEM security parameters (and menus on the instruments front panel). (The OEMEntry passcode entered is compared to the OEMPassword parameter value, when identical access is provided and the OEM security feature loads).
- NOTE:** If an incorrect access code is entered the OEMEntry menu will become non editable for a time period. The time will increase for each incorrect pass code entered.
- OEMEnable OEM security parameter used to switch OEM security feature On (enable) or Off (disable).
This parameter is stored in non-volatile memory. The default value is Off (disable), after an initial Quickcode start.
- OEMPassword OEM security password parameter allows the user to edit the access code (to any value between 0001 and 9999).
This parameter is stored in non-volatile memory. If the OEMPassword parameter value is updated i.e. a new passcode entered the OEMEnable and OEMPassword parameters (and menus) disappear.
- Clear memory When available and set to 'yes', the device clears all configuration data, performs a cold-start and enters the Quickcode mode.

Alarm Configuration

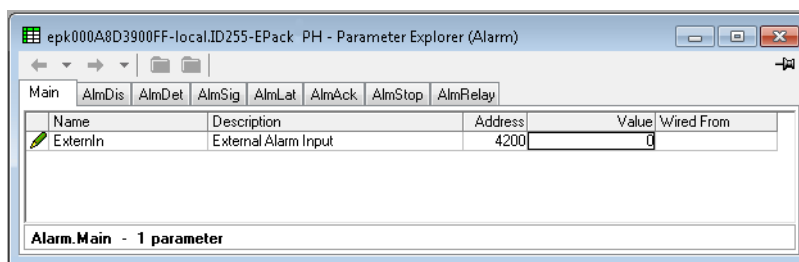

Figure 70 Alarm configuration

Main	'ExternIn' is the input of this block. When connected to digital input 2 (DI2) and DI2 connected to a fuse blown detection contact, this alarm is considered as a 'fuse blown' alarm.
AlarmDis	This allows the listed alarm to be enabled or disabled. 0 = Enable; 1 = Disable.
AlmDet	This parameter indicates whether the alarms has been detected and is currently active. 0 = Inactive; 1 = Active.
AlmSig	Signals that the alarm has occurred and is possibly latched by the Alarm Latch settings. If the user wishes to assign an alarm to, for example, a relay then it is the appropriate AlmSig parameter that should be wired. 0 = Not Latched; 1 = Latched.
AlmLat	The alarm can be configured as latching or non-latching, the latched state being shown in the Alarm Signal (AlmSig) register. 0 = Non-Latching; 1 = Latching.
AlmAck	Allows the alarm to be acknowledged. When an alarm is acknowledged, its related signalling (AlmSig) parameter is cleared. If the alarm is still active (as shown by the detection (AlmDet) parameter) then the alarm cannot be acknowledged. The acknowledge parameters automatically clear after being written. 0 = Do not acknowledge; 1 = Acknowledge.
AlmStop	Allows the alarm to be configured such that it stops the related power channel firing. AlmStop is activated by the signalling parameters and thus may be latching. 0 = Do not stop; 1 = Stop.
AlmRelay	This allows the listed alarm to operate and de-energise the alarm relay when set to active. No (0) = Inactive; Yes (1) = Active. (When utilising AlmRelay function ensure FaultDet/CustomAlarm parameter remains wired to IO.Relay/PV).

Communications Configuration

The communications menu allows the user to view, and in some cases, to edit communications parameters associated with the communications option.

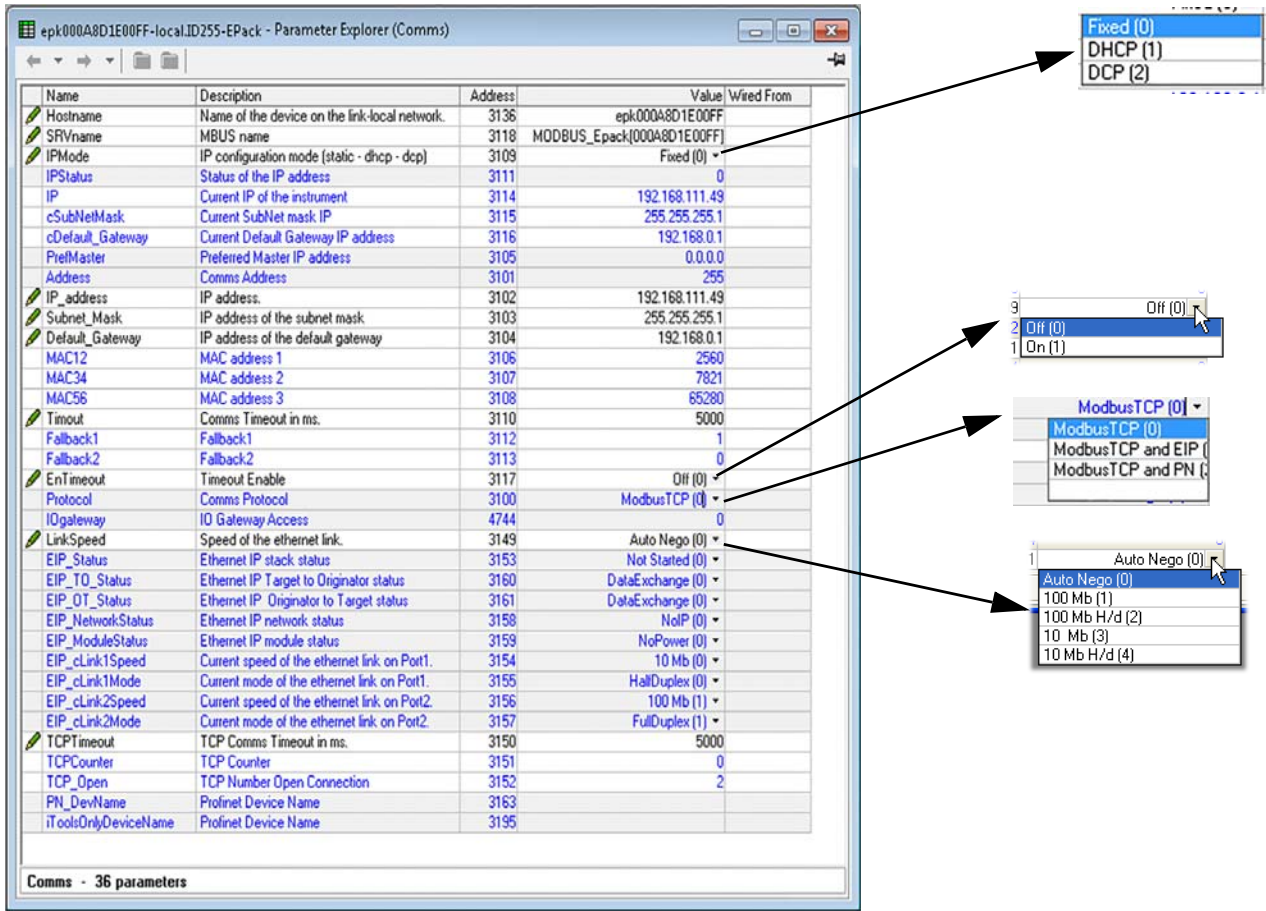

Figure 71 iTools comms page

Host name

The name of the device on the link-local network.

For convenience, the device can declare itself on the pseudo-domain .local. If the hostname of the device is changed, it must be ensured that the name is unique on the network. In this is not the case, the instrument will transparently try to find another unique name automatically.

The default value is related to the MAC address of the device and thus should already be unique.

SRV name

MBUS name. The name of the device, as shown by iTools

IP Mode

The IP configuration mode of the instrument.

0: Static. The IP parameters are taken from the parameter IP-addr, SubNetMark and NetGateway.

1: DHCP. The IP address of the instrument is automatically assigned by an external DHCP server. If the instrument fails to acquire an IP address, the auto IP mechanism assigns an IP to the instrument in the range 169.254.xxx.xxx with subnet mask 255.255.0.0.

2: DCP. The Discovery and Basic Configuration Protocol DCP is a protocol definition within the PROFINET context. It is a Data Link Layer based protocol to configure station names and IP addresses.

IP Status

This (hidden) parameter describes the current status of the IP address of the instrument.

IP

This is the current IP address of the device which may be different from the configured IP address.

cSubnetMask	The current subnet mask associated with 'IP' above.
`cDefault Gateway	The current default gateway associated with 'IP' above.
Pref Master	The IP address of the preferred host.
Address	On a network of instruments this address is used to specify a particular instrument. Each instrument on a network must be set to a unique address, the available address range depending upon the network protocol. As EPack supports only Modbus/TCP protocol, and discrimination on the network is carried out using the IP addresses of the connected instruments, the modbus addresses of the devices are not used.
IP address	The configured IP address of the device
Subnet Mask	The subnet mask associated with 'IP address' above.
Default Gateway	The default gateway associated with 'IP address' above.
MAC12	First two Bytes of the MAC Address 11-22-33-44-55-66
MAC34	Second two Bytes of the MAC Address 11-22- 33-44-55-66
MAC56	Third two Bytes of the MAC Address 11-22-33-44- 55-66
Timeout	Comms timeout value in ms. If no usercomms request arrives within the time specified in this parameter, the Fallback values will change.
Fallback1	Set to 1 when a timeout occurs; set to 0 when communications are operating correctly.
Fallback2	Inverse value of the Fallback1 parameter.
En Timeout	If set to ON (1), the timeout of the comms requests will be monitored. The outputs Fallback1 and Fallback2 will be adjusted accordingly. 0 =Off. 1= On
Protocol	Main communication protocol to access the instrument over Ethernet comms. 0 = ModbusTCP 1 = ModbusTCP and EIP (EtherNet/IP) 2 = ModbusTCP and PROFINET
IO gateway	IP address of IO gateway.
Link Speed	Select a link speed from Auto negotiate, 100MB, 100MB half duplex, 10 MB or 10MB 1/2 duplex.
EIP_Status	Displays the EtherNet/IP stack status, using one of the following values: 0: EtherNet/IP stack not started 1: EtherNet/IP stack ready 2: EtherNet/IP stack Standby 3: EtherNet/IP stack Running
EIP_TO_Status	Displays the EtherNet/IP Target to Originator status, using one of the following values: 0: Data Correctly Exchanged 1: Connection In progress 2: Connection Timeout 3: Connection Timeout 4: Unknown MAC Address 5: Consumption Timeout 6: Connection Closed by Forward Close 7: Module In Stop 8: Encapsulation Error 9: TCP Connection Error 10: No resources to handle connection 11: Bad Format 12: Idle mode 13: Unknow Status

EIP_OT_Status	<p>Displays the EtherNet/IP Originator to Target status, indicated by one of the following values:</p> <table border="0"> <tr> <td>0: Data Correctly Exchanged</td> <td>7: Module In Stop</td> </tr> <tr> <td>1: Connection In progress</td> <td>8: Encapsulation Error</td> </tr> <tr> <td>2: Connection Timeout</td> <td>9: TCP Connection Error</td> </tr> <tr> <td>3: Connection Timeout</td> <td>10: No resources to handle connection</td> </tr> <tr> <td>4: Unknown MAC Address</td> <td>11: Bad Format</td> </tr> <tr> <td>5: Consumption Timeout</td> <td>12: Idle mode</td> </tr> <tr> <td>6: Connection Closed by Forward Close</td> <td>13: Unknow Status</td> </tr> </table>	0: Data Correctly Exchanged	7: Module In Stop	1: Connection In progress	8: Encapsulation Error	2: Connection Timeout	9: TCP Connection Error	3: Connection Timeout	10: No resources to handle connection	4: Unknown MAC Address	11: Bad Format	5: Consumption Timeout	12: Idle mode	6: Connection Closed by Forward Close	13: Unknow Status
0: Data Correctly Exchanged	7: Module In Stop														
1: Connection In progress	8: Encapsulation Error														
2: Connection Timeout	9: TCP Connection Error														
3: Connection Timeout	10: No resources to handle connection														
4: Unknown MAC Address	11: Bad Format														
5: Consumption Timeout	12: Idle mode														
6: Connection Closed by Forward Close	13: Unknow Status														
EIP_Status	<p>Displays the status of the EtherNet/IP network, indicated by one of the following values:</p> <table border="0"> <tr> <td>0: No Power or No IP</td> <td>3: Time Out on Connection</td> </tr> <tr> <td>1: No connection Enabled Unit is On-line (IP address configured) but No connection enabled</td> <td>One or more connection Timeout</td> </tr> <tr> <td>2: Connection established Unit is On-line (IP address configured) and connection enabled</td> <td>4: Fatal error Unit is in Fatal error (like duplicate address)</td> </tr> </table>	0: No Power or No IP	3: Time Out on Connection	1: No connection Enabled Unit is On-line (IP address configured) but No connection enabled	One or more connection Timeout	2: Connection established Unit is On-line (IP address configured) and connection enabled	4: Fatal error Unit is in Fatal error (like duplicate address)								
0: No Power or No IP	3: Time Out on Connection														
1: No connection Enabled Unit is On-line (IP address configured) but No connection enabled	One or more connection Timeout														
2: Connection established Unit is On-line (IP address configured) and connection enabled	4: Fatal error Unit is in Fatal error (like duplicate address)														
EIP_ModuleStatus	<p>Displays the status of the EtherNet/IP module indicated by one of the following values:</p> <table border="0"> <tr> <td>0: No power on the device</td> <td>3: Recoverable Fault</td> </tr> <tr> <td>1: Unit not configured Unit not configured or Scanner in Idle mode</td> <td>An incorrect or inconsistent configuration would be considered a minor fault</td> </tr> <tr> <td>2: Controlled by a scanner in Run state Controlled by a scanner in Run state</td> <td>4: Major Fault Major fault (Exception state, fatal error etc.)</td> </tr> </table>	0: No power on the device	3: Recoverable Fault	1: Unit not configured Unit not configured or Scanner in Idle mode	An incorrect or inconsistent configuration would be considered a minor fault	2: Controlled by a scanner in Run state Controlled by a scanner in Run state	4: Major Fault Major fault (Exception state, fatal error etc.)								
0: No power on the device	3: Recoverable Fault														
1: Unit not configured Unit not configured or Scanner in Idle mode	An incorrect or inconsistent configuration would be considered a minor fault														
2: Controlled by a scanner in Run state Controlled by a scanner in Run state	4: Major Fault Major fault (Exception state, fatal error etc.)														
EIP_cLink1Speed	Displays the current speed of the ethernet link on Port1.														
EIP_clink1Mode	Displays the current mode of the ethernet link on Port1.														
EIP_cLink2Speed	Displays the current speed of the ethernet link on Port2.														
EIP_clink2Mode	Displays the current mode of the ethernet link on Port2.														
TCPTimeout	<p>Timeout used to close an open TCP connection, which are not being used by Master that originally opened it - adjust in configuration mode.</p> <p>Default value is 5000 ms.</p>														
TCPCounter	<p>TCPCounter records the number of times EPack resets itself. A reset takes place if the threshold of detected open connections is exceeded. EPack automatically resets itself.</p>														
TCP_Open	TCP Open is the quantity of live, open connections.														

Control Configuration

The control menu provides the control algorithm to perform power control and transfer, threshold limiting and phase angle reduction (in the case of burst firing). [Figure 72](#), below, gives an overview of the menu, which is described in the following sections:

- Setup
- Main
- Limit
- Diag (Diagnostics)
- AlmDis (Alarm disable)
- AlmDet (Alarm detection)
- AlmSig (Alarm Signalling)
- AlmLat (Alarm latching)
- AlmAck (Alarm Acknowledgement)
- AlmStop (Stop firing on alarm)
- AlmRelay, Control Alarm Relay

Name	Description	Address	Value	Wired From
Standby	Put controller into standby	1056	No (0)	
NominalPV	Nominal PV of this phase of p	1057	52900.00	
EnLimit	Enable Threshold Limit	1058	No (0)	
TransferEn	Enable Transfer (Proportiona	1059	No (0)	
FFTtype	Defines the type of Feed For	1060	Off (0)	
BleedScale	Bleed Back Scalar	1063	10.00	

Control Setup - 8 parameters

Figure 72 Control menu overview

Control setup menu

This contains parameters for setting the type of control to be performed.

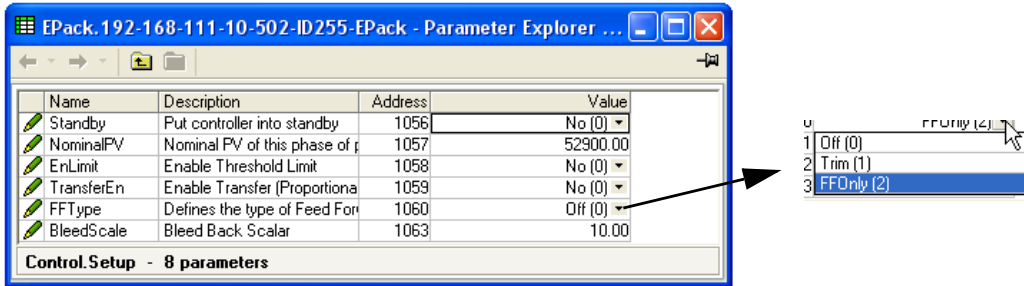

Figure 73 Control setup page

Parameters

- Standby** If Yes (1), the controller enters Standby mode and zero % power is demanded. When removed from Standby (0) the unit returns to operating mode in a controlled manner.
- Nominal PV** Normally the nominal value for each control type. For example, for feedback mode = V^2 , V_{sq} should be wired to the Main PV, and Nominal PV set to the nominal value expected for V^2 (usually $V_{LoadNominal}^2$).
- En Limit** Used to enable/disable threshold limit. (By default the current limit function is enabled).
- Transfer En** Select Transfer Enable (Proportional limit) as 'Yes' (enabled) or 'No' (not enabled).
- FF Type** Feedforward Type.
 Off (0). Feedforward is disabled
 Trim (1). Feedforward value is the dominant element of the output. Trimmed by the control loop based on the Main PV and setpoint.
 FFOnly (2). The feedforward value is the output from the controller. Open loop control may be configured by this means.
- FF Gain** The entered gain value is applied to the Feedforward input.
- FF Offset** The entered value is applied to the Feedforward input after the Gain value has been applied to it.
- Bleed Scale** Internal parameter for use by service personnel

Control Main menu

This menu contains all the parameters associated with the Main control loop.

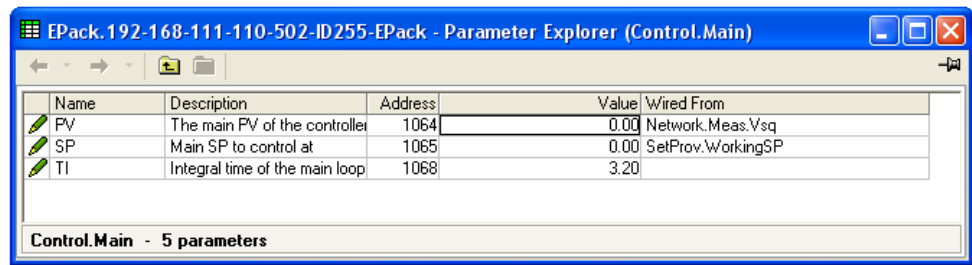

The screenshot shows a window titled "E-Pack.192-168-111-110-502-ID255-E-Pack - Parameter Explorer (Control.Main)". It contains a table with the following data:

Name	Description	Address	Value	Wired From
PV	The main PV of the controller	1064	0.00	Network.Meas.Vsq
SP	Main SP to control at	1065	0.00	SetProv.WorkingSP
TI	Integral time of the main loop	1068	3.20	

Below the table, it says "Control.Main - 5 parameters".

Figure 74 Control 'Main' menu

Parameters

PV	Displays the main Controller Process Variable (PV). Wired to the measurement which it is to be controlled. For example, to perform V^2 control. Vsq should be wired to this (PV) parameter and Nominal PV configured appropriately.
SP	The Setpoint to control at, as a percentage of Nominal PV (the upper range of the loop in engineering units). For example, if Vsq = 193600, and SP is set to 20%, the controller attempts to regulate at $193600 \times 20/100 = 38720$.
Trans PV	Transfer PV. This is the PV measurement for transfer. For example, if a V2 to I2 transfer is required, the Vsq should be wired to MainPV and Isq to TransferPV. Appears only if Trans Enable (Control setup menu) is set to 'Yes'.
Trans SP	The span of operation for transfer. Appears only if Trans Enable (Control setup menu) is set to 'Yes'.
TI	Allows the user to define an integral time for the main PI control loop.

Control limit configuration

This area configures parameters relating to the limit control loop.

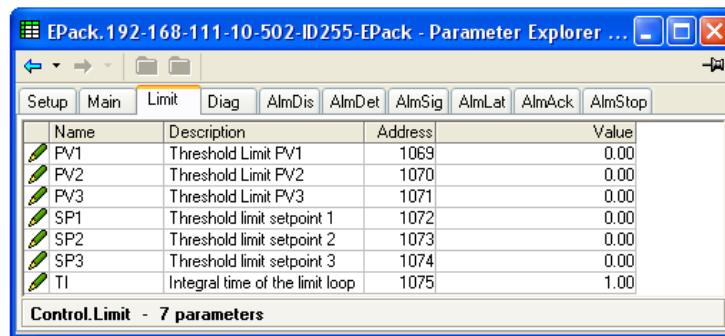

Figure 75 Control limit menu

Parameters

PV1 to PV3	Process value for limit loops 1 to 3 respectively. This is the value to perform threshold limit control. 'Limit Enable' must be set to 'Yes' in the Setup menu (Control setup menu).
SP1 to SP3	The Threshold Setpoint for limit loops 1 to 3 respectively.
TI	The integration time for the limit PI control loop. The default value is firing mode dependent.

Example:

If I² threshold limiting is required, Isq is wired to PV1, and the required threshold value is entered at SP1. In phase angle configuration, the phase angle is reduced to achieve the limit setpoint; in burst firing, the unit continues to fire in bursts, but these bursts are of phase angle in order to achieve the limit setpoint. The modulation continues to attempt to reach the main setpoint.

Also known as phase angle reduction burst firing.

Control diagnostic menu

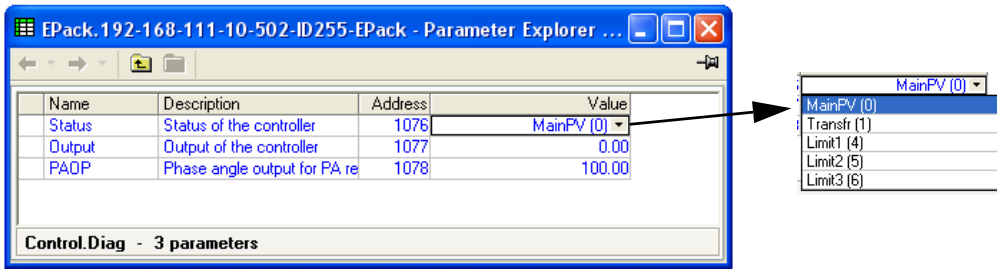

Figure 76 iTools diagnostic menu

Parameters

Status	Indicates the current operating state of the controller: Main PV The control strategy is using Main PV as the control input Transfer The transfer input us being used as the input to th control strategy. Limit1(2)(3) Control limiting is currently active using limit PV1(2)(3) and limit SP 1(2)(3).
Output	The current output demand in percent. Normally wired to Modulator.In or FiringOP.In
PAOP	Applies only to Burst Firing control modes. If this parameter is wired to Firing.limitIn, the power module will deliver bursts of phase angle firing depending both on the Main Setpoint and on the Limit Setpoint.

Control Alarm disable menu

Allows each alarm of the control block to be disabled, individually.

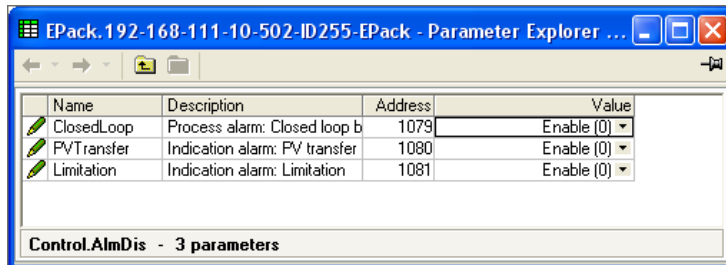

Figure 77 Alarm disable page

Parameters

Closed Loop	Select Enable (0) or Disable (1) for loop break alarm.
PV Transfer	As for Closed Loop, but for the 'Transfer active' alarm.
Limitation	As for Closed Loop, but for the 'Control limit active' alarm.

Control Alarm Detection Parameters

Indicates whether each alarm has been detected and whether or not it is currently active.

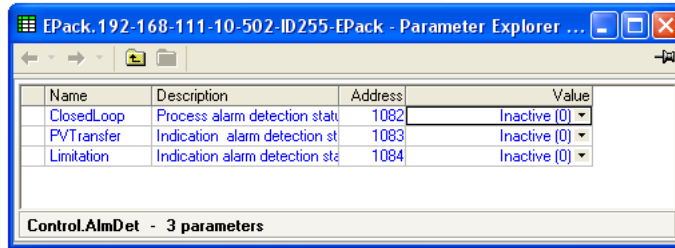

Figure 78 Control Alarm detection page

Parameters

- Closed Loop Displays whether or not the closed loop alarm is currently active.
- PV Transfer As for Closed Loop, but for the 'Transfer Active' alarm.
- Limitation As for Closed Loop, but for the 'Control limit active' alarm.

Control Alarm signalling parameters

Signals that an alarm has occurred and has been latched (if so configured in 'Alarm Latch' (page 119). If it is required that an alarm is to be assigned to a relay (for example), then the appropriate alarm signalling parameter should be used.

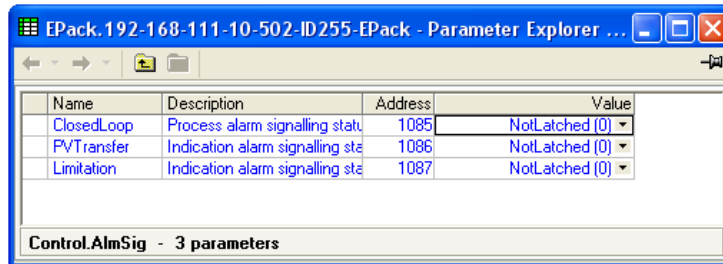

Figure 79 Control Alarm Signalling page

Parameters

- Closed Loop Indicates whether the closed loop break alarm is currently active.
- PV Transfer As for Closed Loop, but for the 'Transfer Active' alarm.
- Limitation As for Closed Loop, but for the 'Control limit active' alarm.

Control Alarm Latch parameters

Allows each alarm to be configured as latching or not latching.

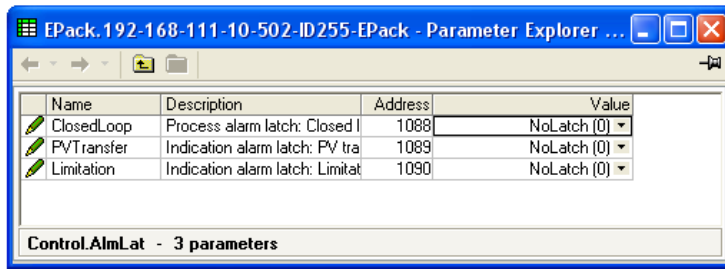

Figure 80 Control Alarm latching page

Parameters

- Closed Loop Set the latching status of the alarm.
- PV Transfer As for Closed Loop, but for the 'Transfer Active' alarm.
- Limitation As for Closed Loop, but for the 'Control limit active' alarm.

Control Alarm Acknowledgement parameters

This menu allows individual alarms to be acknowledged. On acknowledgement, the related Signalling parameter is cleared. The Acknowledge parameters automatically clear after being written.

If the alarm is still active (as shown by the Alarm Detection display) it cannot be acknowledged.

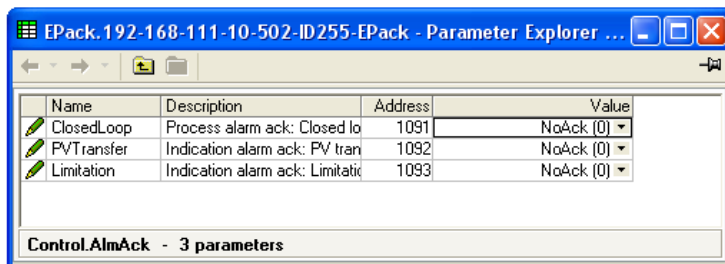

Figure 81 Control Alarm Acknowledge page

Parameters

- Closed Loop Displays whether the closed loop alarm has been acknowledged or not.
- PV Transfer As for Closed Loop, but for the 'Transfer Active' alarm.
- Limitation As for Closed Loop, but for the 'Control limit active' alarm.

Control Alarm Stop parameters

Allows individual channels to be configured such that it will stop the associated power channel from firing whilst the alarm is active. This feature is activated by the signalling parameters, so the alarm stop may be latching.

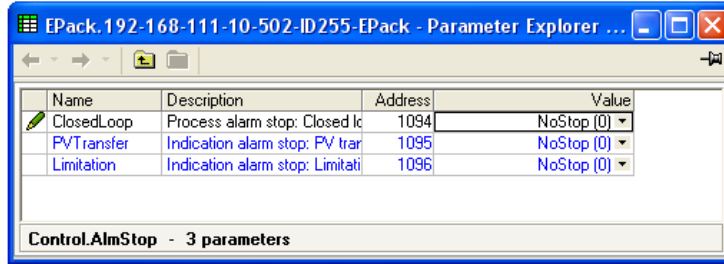

Figure 82 iTools Control Alarm Stop page

Parameters

- Closed Loop** Shows whether the closed loop alarm has been configured to disable firing or not.
- PV Transfer** As for Closed Loop, but for the 'Transfer Active' alarm.
- Limitation** As for Closed Loop, but for the 'Control limit active' alarm.

AlmRelay, Control Alarm Relay

Allows each individual alarm to be configured, so the alarm relay is de-energised (or not), whilst the alarm is active.

NOTE: When utilising Almrelay function ensure FaultDet/CustomAlarm parameter remains wired to IO.Relay/PV.

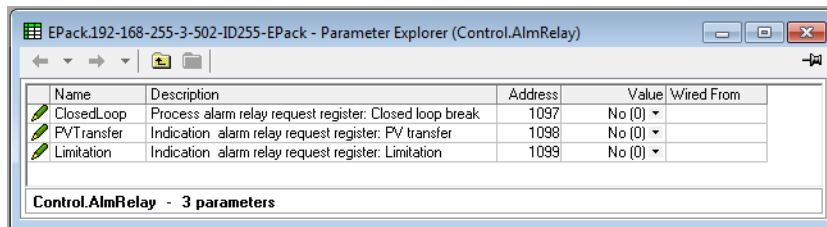

Figure 83 iTools Control Alarm Relay page

Parameters

- Closed Loop** Shows whether the closed loop alarm has been configured to de-energise alarm relay firing, or not.
- PV Transfer** As for Closed Loop, but for the 'Transfer Active' alarm.
- Limitation** As for Closed Loop, but for the 'Control limit active' alarm.

Counter Configuration

The counter output is a 32-bit integer the value of which is recalculated every sample period. When a clock state change from 0 (false) to 1 (true) is detected the counter value is incremented if the count direction is 'up' or decremented if the direction is 'down'.

At reset, the counter value is set to 0 for count up counters or to the 'Target' value for count down counters.

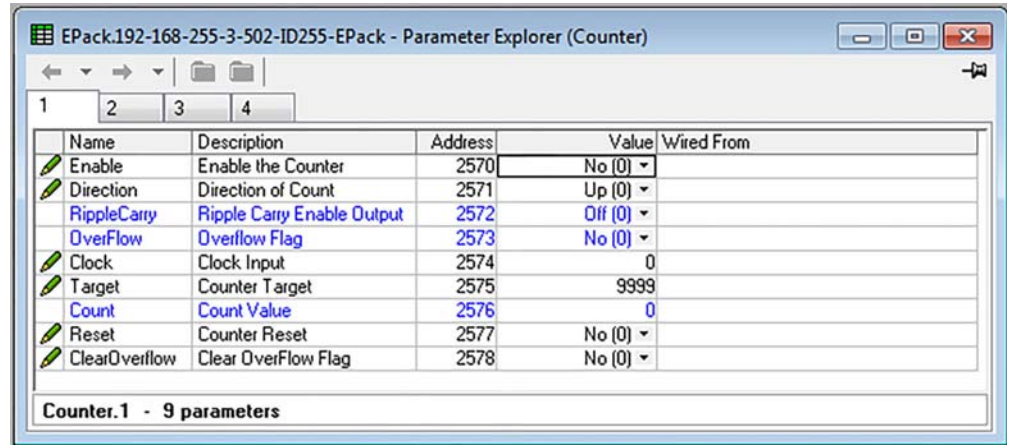

Figure 84 iTools Counter page

Parameters

- Enable** The counter responds to clock transitions when enabled; the count is frozen when disabled.
- Direction** Select up or down as the direction of count. Up counters start at (and are reset to) zero; down counters start from (and are reset to) the Target value (below)
- Ripple Carry** The Ripple carry output of one counter can act as the enabling input for the next counter in a cascade. Ripple carry is set 'true' when the counter is enabled and its value is either zero (for count down timers) or equal to the Target value (count up counters).
- Overflow** Overflow becomes 'true' when the value of the counter is either zero (for count down timers) or equal to the Target value (count up counters).
- Clock** The counter increments or decrements on a positive going edge (0 to 1; False to true).
- Target** Up counters: Start at zero and count towards the Target value. When this value is reached, Overflow and Ripple-carry are set true (value = 1).
Down counters: Start at the Target value and count towards zero. When zero is reached, Overflow and Ripple-carry are set true (value = 1).
- Count** The current value of the counter. This is a 32-bit integer which accumulates clock transitions. Minimum value is zero.
- Reset** Resets up-counters to zero or down-counters to the Target value. Reset also sets Overflow to False (i.e. Overflow = 0)
- Clear Overflow** Sets Overflow to False (i.e. Overflow = 0)

Cascading Counters

As implied above, it is possible to 'wire' counters in cascade mode. Details for an 'up' counter are shown in figure 85. Down counter configuration is similar.

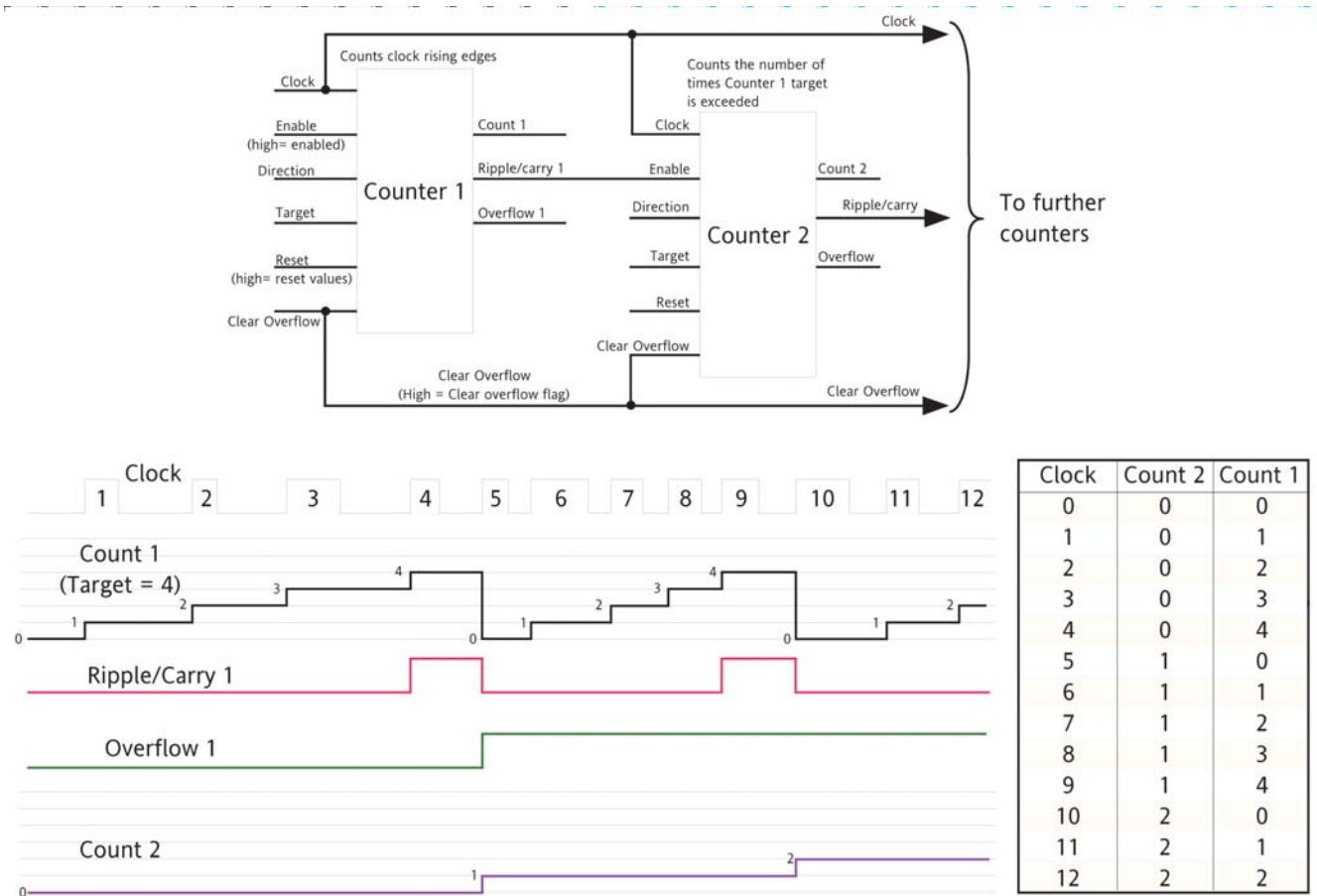

Figure 85 Cascading up counters

NOTE: Note: Counter 2 above counts the number of times that Counter 1 target is exceeded. By permanently enabling counter 2, and wiring counter 1 'Ripple Carry' output to counter 2 'Clock' input (replacing the connection to the clock pulse stream), counter 2 will indicate the number of times counter 1 target is reached, rather than exceeded.

Energy Configuration

Provides a number of energy counters to totalise consumed energy. The power consumed can be displayed in one of number of units, ranging from W to GW.

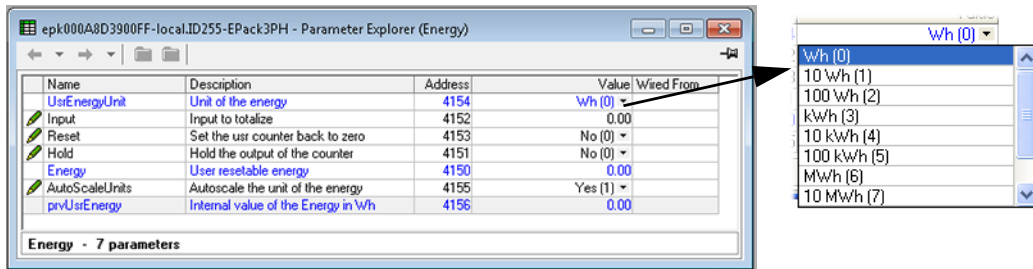

Figure 86 Energy configuration page

Parameters

- UsrEnergyUnit** Allows a scaling units value to be entered for the energy display. Selectable as '1Wh', '10Wh', '100Wh', '1kWh', '10kWh', '100kWh', '1MWh', '10MWh', '100MWh' or '1GWh'.
- Input** Shows the instantaneous power input from the measuring source. Normally wired to the Meas.P output of the block.
- Reset** 1 = Energy counter output goes to zero and immediately starts accumulating.
0 = Energy counter not reset.
- Hold** 1 = Hold output value. This freezes the output value for the block at the current value. The input continues to be totalised, so when the Hold input returns to 0, the output value is instantaneously updated to the new current value.
0 = output value is not held, and represents the current accumulated Energy value.
- Energy** Shows the current value for the selected Energy Counter block.
- Autoscale** No = Use UsrUnit setting.
Yes = Autoscale power value display (table 4).

Power range (Watt-hours)	Scaler value
0 to 65535	1
65,535 to 65,535,000	1k
65,535,000 to 655,350,000	10k
655,350,000 to 6,553,500,000	100k
6,553,500,000 to 65,535,000,000	1M
65,535,000,000 to 655,350,000,000	10M
655,350,000,000 to 6,553,500,000,000	100M
6,553,500,000,000 upwards	1G

Table 4: Scaler values

Resolution

The resolution of the stored energy value varies according to the totalised value, as shown in table below. For example, for stored values between 33,554,432 watt-hours and 67,108,863 watt-hours, the value increases in 4 watt-hour increments.

Power range (Watt-hours)	Resolution (W-h)	Power range (Watt-hours)	Resolution (W-h)
0 to 16,777,215	1	17,179,869,184 to 34,359,738,367	2048
16,777,216 to 33,554,431	2	34,359,738,368 to 68,719,476,736	4096
33,554,432 to 67,108,863	4	68,719,476,736 to 137,438,953,471	8192
67,108,864 to 134,217,727	8	137,438,953,472 to 274,877,906,943	16384
134,217,728 to 268,435,455	16	274,877,906,944 to 549,755,813,887	32768
268,435,456 to 536,870,911	32	549,755,813,888 to 1,099,511,627,776	65536
536,870,912 to 1,073,741,823	64	1,099,511,627,776 to 2,199,023,255,551	131072
1,073,741,824 to 2,147,483,647	128	2,199,023,255,552 to 4,398,046,511,103	262144
2,147,483,648 to 4,294,967,295	256	4,398,046,511,104 to 8,796,093,022,207	524288
4,294,967,296 to 8,589,934,591	512	8,796,093,022,208 to 17,592,186,044,415	1048576
8,589,934,592 to 17,179,869,183	1024		

Table 5: Energy counter resolution

Fault Detection Menu

This manages Alarm logging and provides an interface for the General Alarm Acknowledgement.

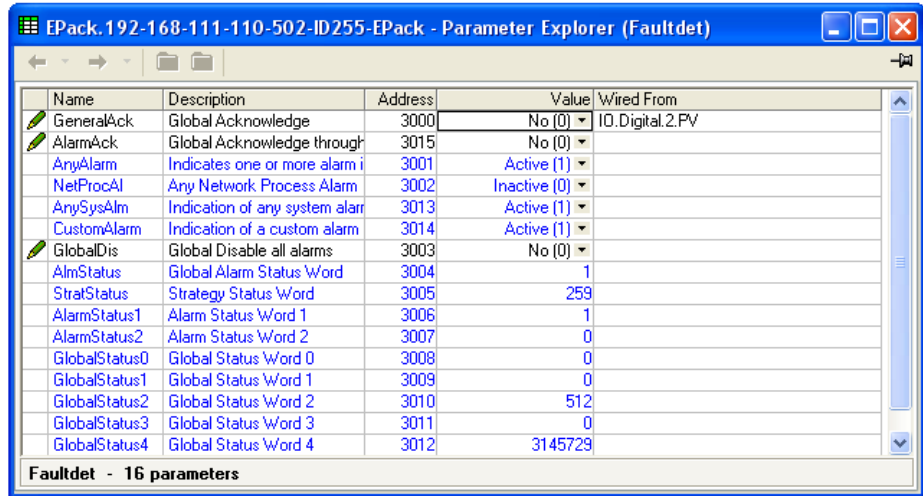

Figure 87 Fault detection menu page

Parameters

- General Ack** Performs a global acknowledgement of alarms. Latched alarms are cleared if their trigger sources are no longer in an alarm state. Wired by default from Digital input 2.
- AlarmAck** Enables global alarm acknowledgement from front fascia.
- Any Alarm** ‘Active’ indicates that there is one or more System, Process or ‘Chop Off’ alarm active. If the relevant alarms are enabled, System alarms and Chop Off alarms always cause the power module to stop firing. Process alarms can also be configured to prevent firing in ‘Alarm stop’.
- NetProcAl** Indicates that a process alarm has occurred in the power network.
- AnySysAlm** Indicates that a systems alarm is active. By default, this is wired to Custom Alarm, see below.
- Custom Alarm** Indicates that an alarm using rules defined by user, is active. By default, this is wired to IO Relay.PV.
(See [AlmRelay tab](#) in corresponding function block)
- Global Disable** Allows the user to disable/enable all alarms.

StratStatus A coded status word giving strategy information as shown in table 6.

Bit	Value	Description
0	1	Not firing
1	2	Not synchronising
2	4	Reserved
3	8	Reserved
4	16	Reserved
5	32	Reserved
6	64	Reserved
7	128	Strategy in standby mode
8	256	Strategy in Telemetry mode
9	512	Reserved
10	1024	Reserved
11	2048	Reserved
12	4096	Reserved
13	8192	Reserved
14	16384	Reserved
15	32768	Reserved

Table 6: Strategy status

Alarm Status 1(2) Two 16-bit words containing alarm status information as shown in table 7.

Bit	Value	Description	Bit	Value	Description
0	1	Missing mains	0	1	Closed loop
1	2	Thyristor short circuit	1	2	Transfer active
2	4	Over temp*	2	4	Limit active
3	8	Dips	3	8	Reserved
4	16	Frequency fault	4	16	Reserved
5	32	Total Load Failure	5	32	Reserved
6	64	Chop off	6	64	Reserved
7	128	Partial load failure	7	128	Reserved
8	256	Partial load unbalance	8	256	Any bit in Global Status 0
9	512	Over voltage	9	512	Any bit in Global Status 1
10	1024	Under voltage	10	1024	Any bit in Global Status 2
11	2048	Pre temp*	11	2048	Any bit in Global Status 3
12	4096	Over current	12	4096	Reserved
13	8192	Reserved	13	8192	Reserved
14	16384	Analogue input over C	14	16384	Reserved
15	32768	External input	15	32768	Reserved

Table 7: Alarm status word 1

Alarm status word 2

NOTE: * These alarms not applicable at this release but are reserved for future development.

Firing Output Menu

This forms the link between the control strategy and the physical load. This block also supplies Phase-Angle Ramp (Soft start) and Safety Ramp.

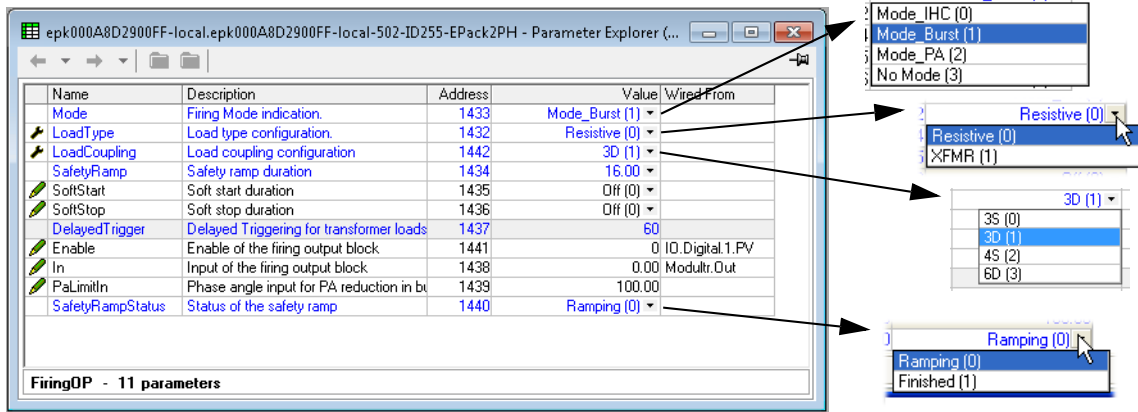

Figure 88 iTools configuration firing output page

- Mode** Displays the current firing mode as Intelligent half cycle (IHC), Burst firing, Phase angle firing or no mode. Configured in the 'Modultr', menu described below.
- Load Type** Allows the load type to be selected as 'Resistive' or 'Transformer'. For Load type = Resistive, the load must be connected directly to the power module and only resistive loads may be so connected. For Load Type = Transformer, the load is connected to the power module via a transformer, and may be resistive or reactive.
- Load Coupling** For 2 phase systems, this allows the user to select one of the following wiring configurations:
3 Delta (3D) or 3 Star (3S)
- Safety Ramp** Displays the safety ramp duration, in supply voltage cycles (0 to 255), to be applied at startup. The ramp is either a phase angle ramp from zero to the requested target phase angle or, for Burst Firing, from 0 to 100%. See Figures 89. Safety Ramp is not applicable to Half cycle Mode.
- Soft Start** For Burst Firing only, this is the soft start duration, in supply voltage cycles, applying a phase angle ramp at the beginning of each on period (Figures 90).
- Soft Stop** In Burst Firing, the soft stop duration, in supply voltage cycles, applying a phase angle ramp at the end of each on period.
- Delayed Trigger** Appears only if Mode = Burst, Soft Start = Off, and Load Type = TxFormer. Delayed Trigger specifies the triggering delay, in phase angle, when delivering power into a transformer load. Used to minimise inrush current. the value is configurable between 0 and 90 degrees inclusive (Figures 91).
- Enable** Enables/disables firing. Must be wired to a non-zero value to enable firing (typically a digital input).
- In** Displays the input power demand value that the power module is to deliver.
- PA Limit** Phase angle limit. This is a phase angle reduction factor used in Burst Firing. If lower than 100% the power module will deliver a burst of phase angle firing. Used, typically, to perform threshold current limiting in Burst Firing.
- Ramp Status** Displays the safety ramp status as 'Ramping' or 'Finished'.

Examples

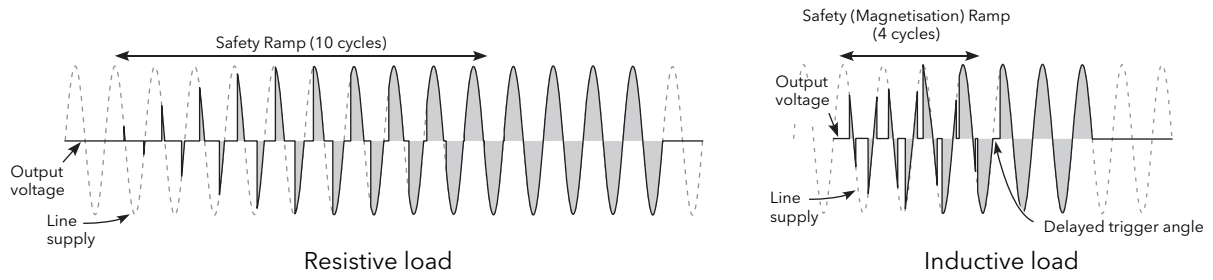

Figure 89 Safety ramp (burst firing) examples

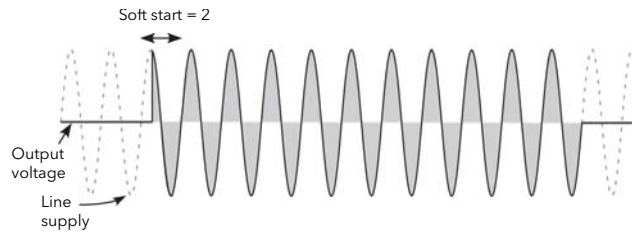

Figure 90 Soft start example

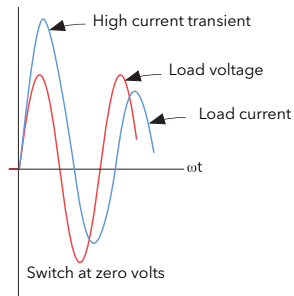

Figure 91 Delayed trigger definition

NOTE: Waveforms have been idealised for clarity.

Input/Output (IO) Configuration

This area of configuration allows the user to configure the analogue and digital inputs and to view the status of the Relay output. The configuration is separated into the following areas:

- "Analogue Input configuration" on page 130
- "Digital Input configuration" on page 132
- "Relay status" on page 133

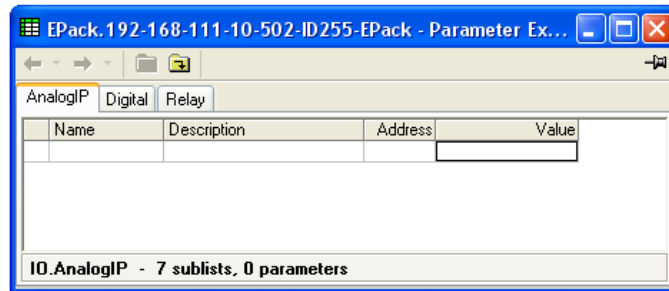

Figure 92 Top level IO menu

Analogue Input configuration

The configuration for the analogue input is divided into a number of areas:

- Ai Main,
- AlmDis,
- AlmDet,
- AlmSig,
- AlmLat,
- AlmAck,
- AlmStop
- AlmRelay

Ai Main

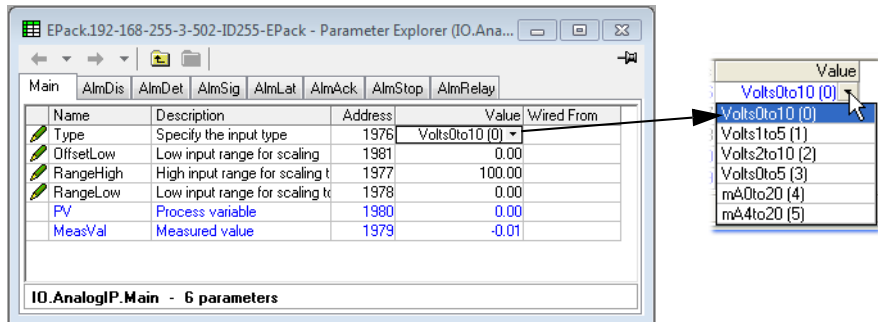

Figure 93 iTools analogue input page

Parameters

- Type** Allows the type of input to be set as one of: 0 to 10V, 1 to 5V, 2 to 10V, 0 to 5V, 0 to 20mA, 4 to 20mA. For pinout details, see [Figure 13](#).
- OffsetLow** An offset, which is used to adjust measured value. The parameter value can be set from -1 to 1 in electrical units (depending on input type) and is added to MeasVal. This can be used to compensate for any errors or noise on the analog input.
- RangeHigh** High range of input for scaling from measurement units to process units. PV is clipped to range high if input goes over range.
- RangeLow** Low range of input for scaling from measurement units to process units. PV is clipped to range low if input goes under range.
- PV** The scaled value in process units. Clipped to the Range High or Range Low value if the signal goes over range or under range respectively.
- MeasVal** The value at the instrument terminals, including the OffsetLow parameter value in electrical units.

AlmDis

Allows the user to enable or disable alarms individually

Example

The figure below shows an iTools page for AlmDis. Pages for the other Alm parameters are similar.

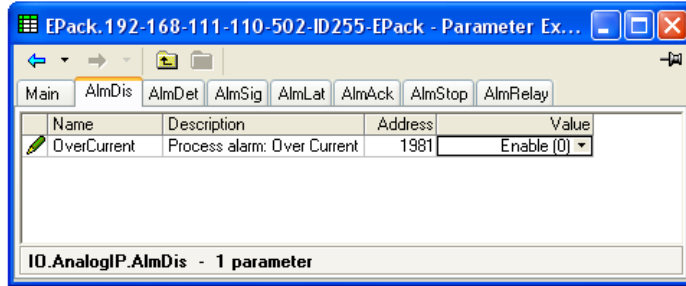

Figure 94 AlmDis example

AlmDet

Indicates whether each individual alarm has been detected and is currently active. This alarm becomes active if the input current goes higher than 25mA, in this case the Analogue Input type is automatically switched to 0-10V to avoid damage.

AlmSig

Signals that an alarm has occurred, and whether or not it is a latched. If the user wishes to assign an alarm to for example a relay then the appropriate signalling parameter should be wired.

AlmLat

Allows each individual alarm to be configured as latching, the latched state is shown in the alarm signalling parameter

AlmAck

Allows each individual alarm to be acknowledged. On an alarm being acknowledged the related signalling parameter (Almsig) is cleared. If the alarm is still active as shown by the detection parameter (Almdet) the alarm may not be acknowledged. The acknowledge parameters automatically clear after being written.

AlmStop

Allows each individual alarm type to be configured to stop the power channel firing. ALMSTOP is activated by the signalling parameter (Almsig) and may be latching or not according to the AlmLat setting for the alarm.

AlmRelay

Causes the relay to be controlled by this alarm

NOTE: When utilising Almrelay function ensure FaultDet/CustomAlarm parameter remains wired to IO.Relay/PV.

Digital Input configuration

This allows the user to configure each of the digital inputs.

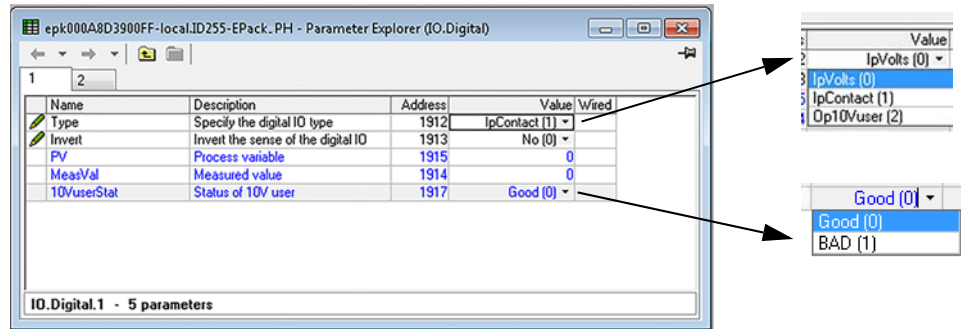

Figure 95 iTools Digital Input configuration page, (digital input 2 displayed)

Parameters

- Type

Select to configure the Logic Input type:
 0 = IpVolts.
 1 = IpContact.
 2 = Op10Vuser.
- Invert

For pinout details, see [figure 12](#).
 Sets the inversion status to 'No' or 'Yes'.
 When set to 'No', there is no inversion (e.g. if MeasVal = 0 then PV = 0).
 When set to 'Yes', an inversion takes place (e.g. if MeasVal = 0 then PV = 1)
- PV

The current state of the input, after any inversion has been applied.
- MeasVal

For inputs, this shows the value measured at the instrument terminals, in electrical units.
- 10VuserStat

Displays the 10V user inputs status;
 Good (0) = No issue can deliver 10V
 BAD (1) = No 10V output, possible short circuit or excessive current requirement.

Example: The 10V user input would typically be used to connect a potentiometer located on a cabinets front fascia, which would be used to adjust setpoint values via digital input 1.

NOTE: The 10V user input is available using digital input 2.

Relay status

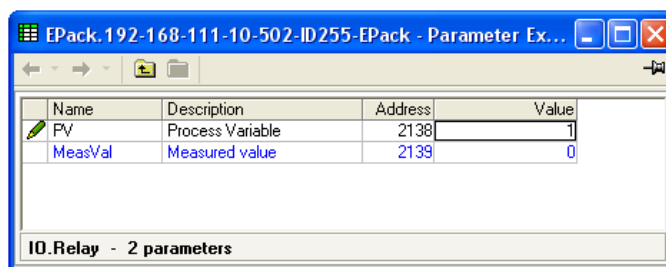

Name	Description	Address	Value
PV	Process Variable	2138	1
MeasVal	Measured value	2139	0

IO.Relay - 2 parameters

Figure 96 iTools relay status page

Parameters

PV	This shows the status of the input to the relay as either 'On' (True) or 'Off' (False).
Meas Val	Shows the current state of the relay coil. 1 = energised; 0 = de-energised, where 'energised' is 'off' and 'de-energised' is 'on'. For pinout details, see figure 13 . For specification, see Relay Specification (page 206) .

Instrument Configuration Menu

Instrument configuration is divided into the following sections:

- "Instrument Display configuration" on page 134
- "Instrument Config configuration" on page 135
- "Instrument configuration" on page 136
- "Scaling Factor" on page 137

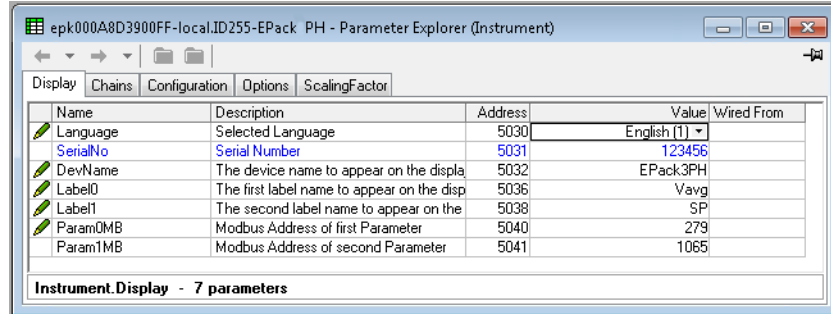

Figure 97 Top level instrument configuration page

Instrument Display configuration

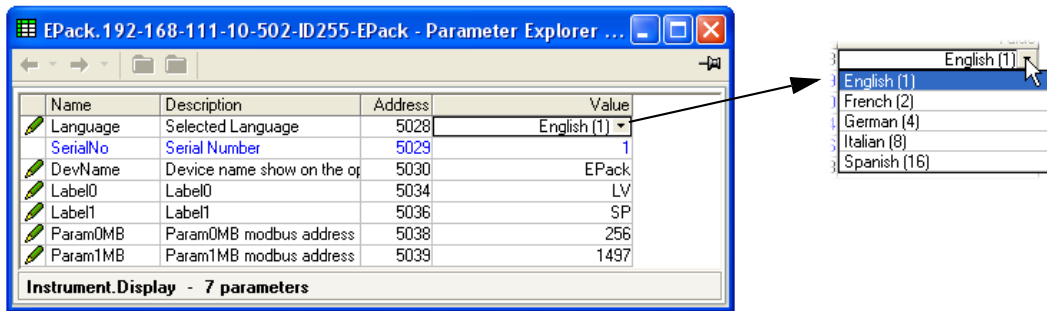

Figure 98 Instrument display configuration page

Parameters

- Language** Select required language for subsequent displays.
- Serial No** Read only. Displays the factory-set Serial number of the unit.
- Dev Name** The device name as it appears at the user display.
- Label 0(1)** The text that appears on the home page for the two parameters defined by the addresses listed in Param0 and Param1. User-definable 3 characters (maximum).
- Param0(1)MB** This is the modbus address of the first (second) parameter to be displayed in the home screen of the instrument.

Instrument Config configuration

The current hardware configuration

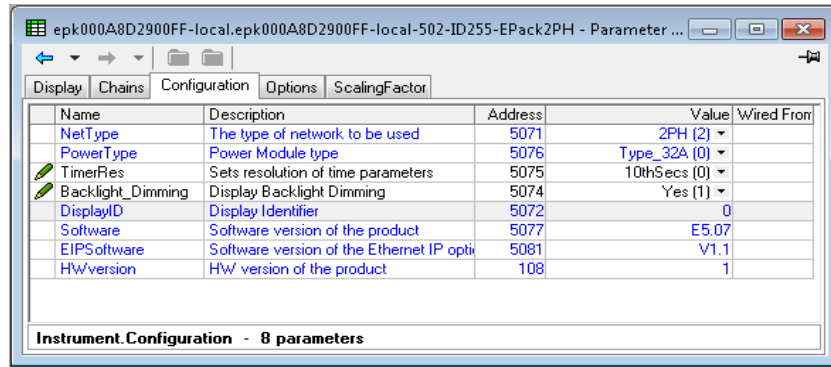

Figure 99 Instrument configuration.

Parameters

- Net Type** Network type. This is set at the factory and cannot be changed by the user.
 0 = 3 phase
 1 = Single phase
 2 = 2 phase
- Power Type** This is set at the factory and cannot be changed by the user, (0 = 32A, 1 = 63A, 2 = 100A, 3 = 125A)
- Timer Res** Resolution of time parameters
 0 = 10ths of seconds (100ms); 1 = 10ths of minutes (6 seconds)
- Backlight_Dimming** Option to control the displays backlight by switching dimming on to reduce power consumption:
 0 = No (deactivate dimming)
 1 = Yes (activates dimming)
- DisplayID** Displays details of the manufacturer display (screen) type:
 0 = Tianma
 1 = Densitron
- Software** Software version of the product.
- EIPSoftware** Software version of the EtherNet/IP option.
- HWversion** Displays product hardware version set at factory (read only parameter).

Instrument configuration

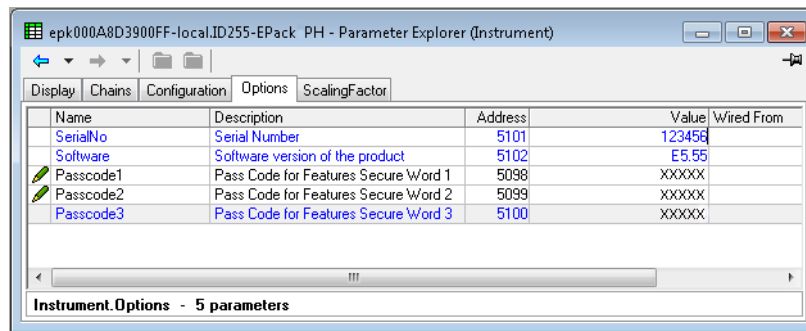

Figure 100 Instrument configuration page

Parameters

SerialNo	The instrument serial number.
Software	The version of software running on this instrument
Passcode1 (2)(3)	Pass Code for Features Secure Word 1(2)(3).

Scaling Factor

Allows scaling factors to be entered for a number of parameters. In iTools, the scaling factors are arranged in 'tabs' of which, for the sake of clarity, this document depicts only one (SetProv).

These scaling factors are applied in modbus transactions when access to relevant parameters is made using low range address (i.e. not the IEEE region).

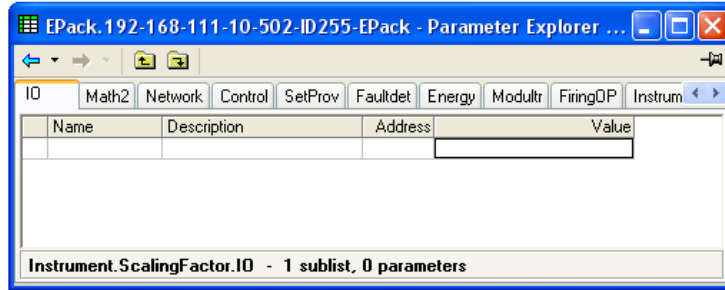
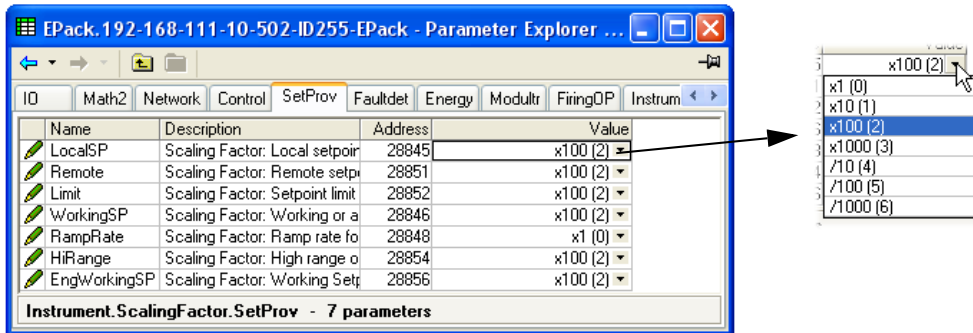

Figure 101 Scaling factor top level menu.

SetProv Example



In the above example it can be seen that all the Set point provider parameters are scaled x100, except for Ramp Rate which is not scaled (i.e. the scaling factor = 1). As can also be seen, the scaling factors available are x1, x10, x100, x1000, ÷10, ÷100, ÷1000.

If the LocalSP, for example, has a scaling factor of x100, as above, then a value of say 5000 means in fact that the real value is 50.00.

NOTES:

1. The above example shows the default scaling formats set - they are User configurable.
2. Values are rounded up/down.

IP Monitor Configuration

This monitors a wired parameter and records its maximum value, minimum value and the cumulative time that its value spends above a configurable threshold. An alarm can be set up to become active when the time-over-threshold exceeds a further threshold.

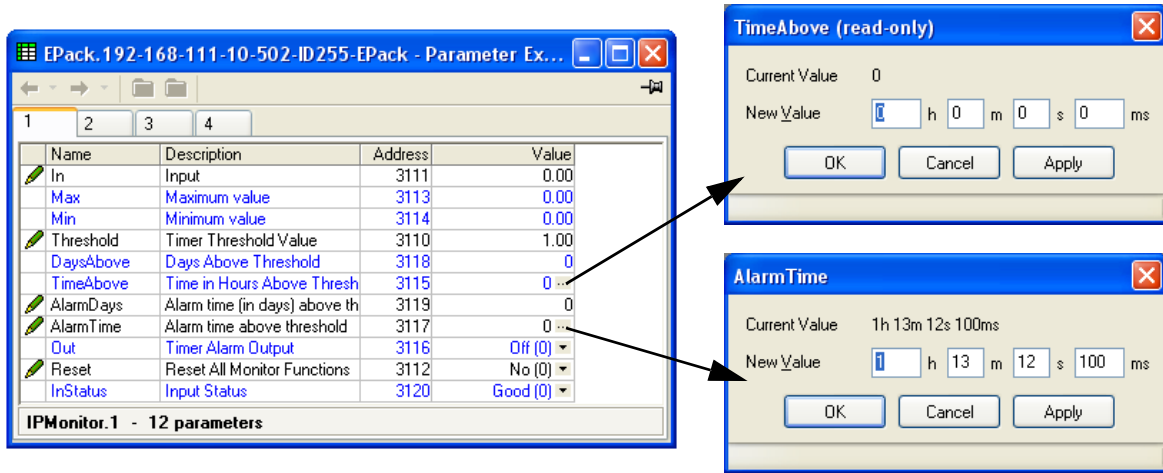

Figure 102 iTools input monitor page (IPMon1)

Parameters

- In** The parameter to be monitored. Normally wired (using iTools) to a parameter, but a numeric entry can be made for testing purposes.
- Max** The maximum value reached by the parameter since last reset.
- Min** The minimum value reached by the parameter since last reset.
- Threshold** This value acts as a trigger for the 'Time Above' measurement.
- Days above** Shows how many complete days the parameter value has spent above the Threshold value (continuously or intermittently) since last reset. The 'Time Above' value should be added to 'Days Above' in order to find the total time.
- Time Above** Shows how many hours, minutes and tenths of minutes that the parameter value has spent above the threshold value (continuously or intermittently) since last reset, or since the last complete day. (once the value exceeds 23:59.9, the 'Days Above' value is incremented and 'Time Above' is reset to 00:00.0.) The 'Time Above' value should be added to 'Days Above' in order to find the total time.
- Alarm Days** Together with 'Alarm Time' this defines a 'total time above threshold' value, which, when exceeded, sets the Alarm out parameter 'On'.
- Alarm Time** See 'Alarm Days' above.
- Reset** Resetting causes the Max. and Min. values to be set to the current value, sets the 'Days Above' value to zero, and the 'Time Above' value to 00:00.0.
- Status** Shows the status of the input parameter as either 'Good' or 'Bad'.

Lgc2 (Two Input Logic Operator) Menu

This logic operator block provides a number of two-input logic operations. The output is always a 'Boolean' (logic 0 or 1) no matter whether the inputs are analogue or digital. For analogue inputs, any value below 0.5 is deemed to be logic 0 (off). A value equal to or greater than 0.5 is treated as a logic 1 (on).

Either input can be 'inverted' as a part of the configuration (that is, a high input is treated as a low input and *vice-versa*.)

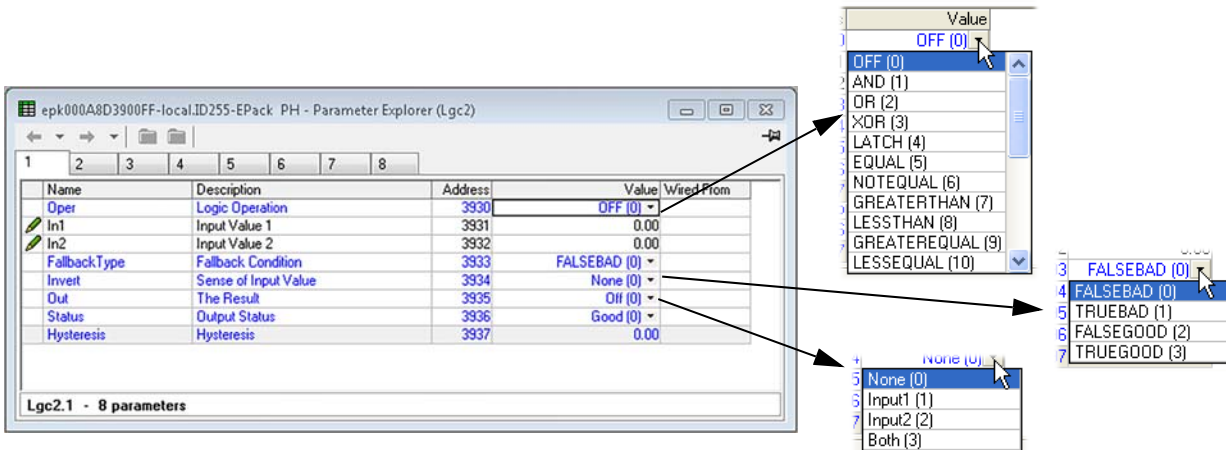

Figure 103 Lgc2 page (Lgc2 1)

Lgc2 Parameters

Oper

Allows the user to select a logic operation for the block. The descriptions below assume neither input is inverted. High = 1 or on; Low = 0 or off.

Off No logic operation selected.

AND Out is high if both inputs high, otherwise Out is low.

OR Out is high if either or both inputs high, otherwise Out is low.

XOR Output high if either (but not both) inputs high. Low if neither or both inputs are high.

Latch If In2 low, Out latches next transition of In1. Value remains latched until In2 goes low, when Out = In1 (see figure 104).

Equal Out high if both inputs are equal, otherwise output is low.

Not Equal Out is high if inputs are unequal. Out is low if inputs are equal.

Greater than Out is high if In1 value greater than In2 value, otherwise Out is low.

Less than Out is high if In1 value less than In2 value, otherwise Out is low.

GreaterEqual Out is high if In1 value is equal to or greater than In2 value, otherwise Out is low.

LessEqual Out is high if In1 value is less than or equal to In2 value, otherwise Out is low.

In1

If wired, shows the value of In1; if not, allows the user to enter a value.

In2	If wired, shows the value of In2; if not, allows the user to enter a value.
Fallback type	Allows a fallback type to be selected. This defines the output value and status displays if the status of one or both inputs is 'bad'. FalseBad Output value displays 'False' ; Status displays 'Bad' TrueBad Output value displays 'True' ; Status displays 'Bad' FalseGood Output value displays 'False' ; Status displays 'Good' TrueGood Output value displays 'True' ; Status displays 'Good'.
Invert	Allows none, either or both inputs to be inverted.
Out	Shows the current output value
Status	Shows the status of the output ('Good' or 'Bad').
Hysteresis	For comparison operators only (e.g. Greater than) this allows a hysteresis value to be entered. For example, if the operator is 'Greater than' and hysteresis is H, then the output goes high when In1 exceeds In2, and remains high until In1 falls to a value less than (In2 - H). Not applicable to the 'Equal' function.

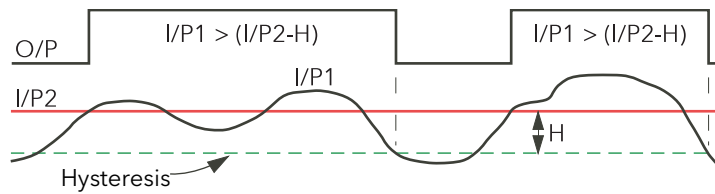
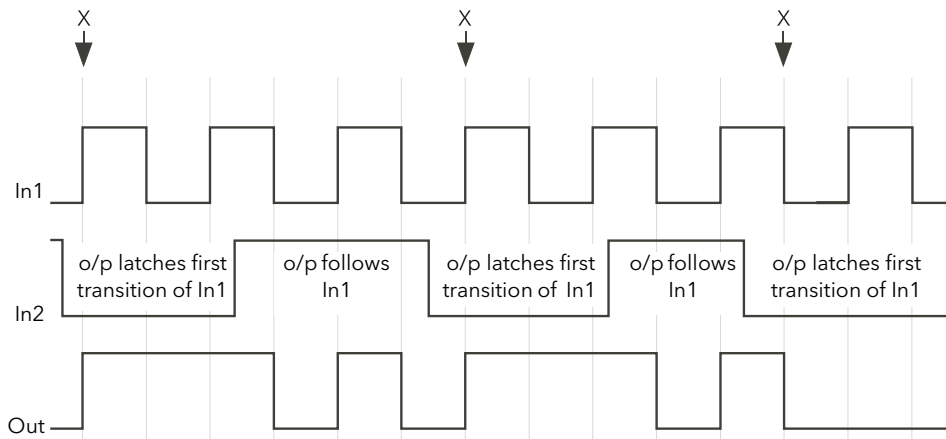

Figure 104 Hysteresis



When In2 goes low, Out follows the next positive or negative transition of In1 (points 'X') and latches at this value until In2 goes high. When In2 is high, Out follows In1.

Figure 105 Latch operation

Lgc8 (Eight-input Logic Operator) Configuration

This allows between 2 and 8 inputs to be combined using an AND, OR or Exclusive OR (EXOR) logic function. The inputs may be individually inverted, and the output can also be inverted, thus allowing the full range of logic functions to be implemented.

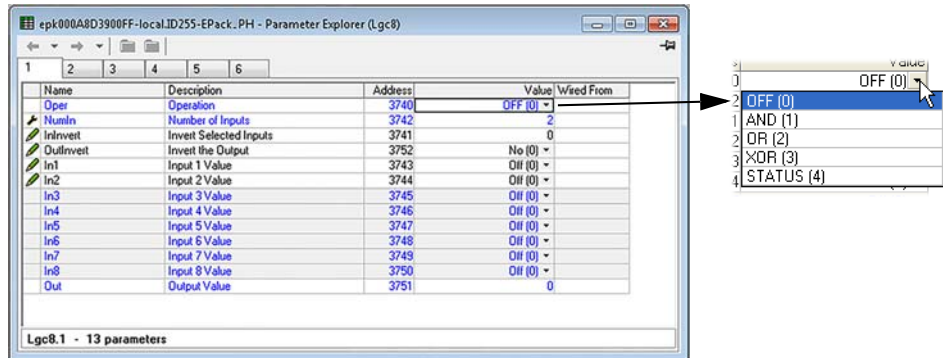

Figure 106 Lgc8 configuration page

Parameters

- Oper** Allows selection of AND, OR or Exclusive OR functions (or OFF).
 AND = output is high only if all inputs are high
 OR = output is high if any or all inputs are high
 XOR = output is high if an odd number of inputs are high, and low if an even number of inputs are high. Logically, a cascaded XOR function: $(((((In1 \oplus In2) \oplus In3) \oplus In4) \dots \oplus In8)$
 Status = Bit to bit OR of the inputs concatenated into a word.
- NumIn** Set the number of inputs to between two and eight inclusive. This number defines how many invert keys appear in 'Invert', and how many Input value pages appear.
- InInvert** Allows the user to invert individual inputs, as described below.
- Out Invert** No = normal output; 'Yes' means that the output is inverted, allowing NAND and NOR functions to be implemented.
- In1** The state (on or off) of the first input
- In2 onwards** The state of the remaining inputs
- Out** The Output value of the function (i.e. On or Off)

Inversion schematic

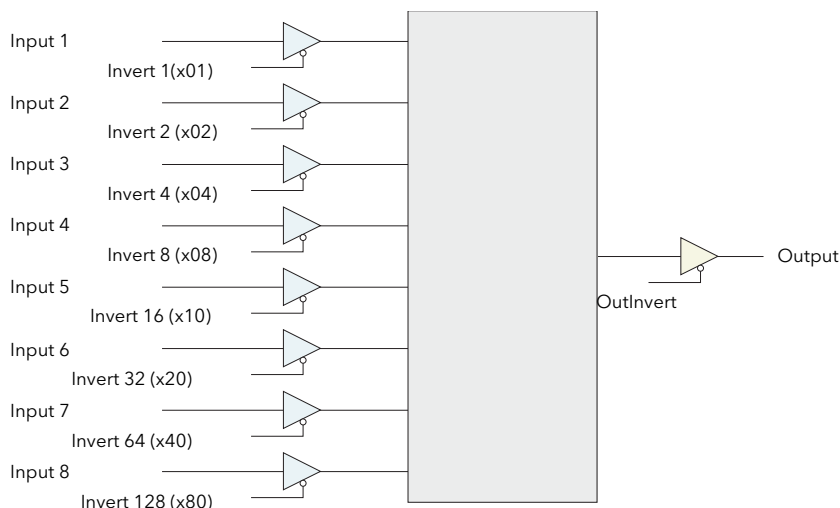

Figure 107 LGC8 inversion Schematic

Math2 Menu

This feature allows a range of two-input mathematical functions to be performed. The available functions are listed below.

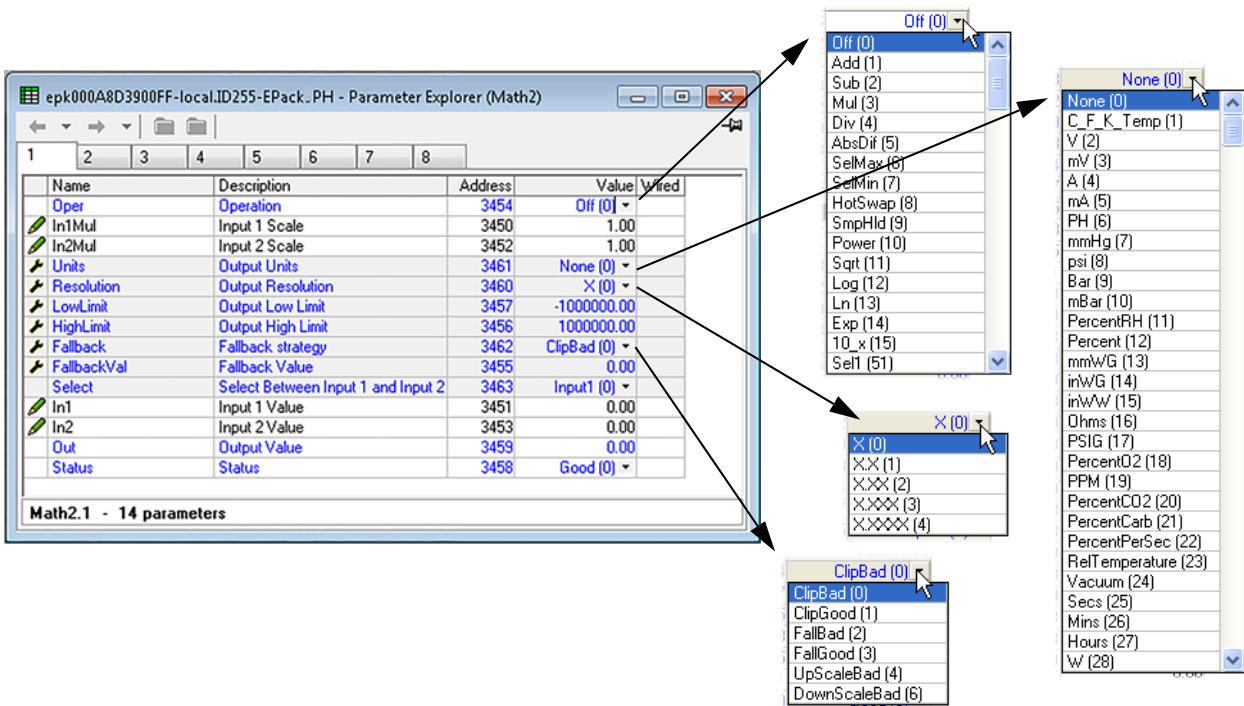

Figure 108 Maths2 configuration page

Math2 Parameters

NOTE: For the sake of this description, 'High', '1' and 'True' are synonymous, as are 'Low', '0' and 'False'.

Oper	Defines the mathematical function to be applied to the inputs
None	No operation.
Add	Adds input one to input two.
Sub	Subtracts input two from input one.
Mul	Multiplies inputs one and two together.
Div	Divides input one by input two.
AbsDif	The difference in value between inputs one and two, ignoring sign.
SelMax	Output = the higher of inputs one and two.
SelMin	Output = the lower of inputs one and two.
HotSwap	Input one appears as the output for as long as input one is 'good'. If input one status is bad, input two appears as the output instead.
SmpHld	Sample and Hold. The output follows input one, for as long as input two is high (sample). When input two goes low (hold), the output is held, at the value current when the output went low, until input two goes high again. Input two is normally a digital value (low = 0 or high = 1); when it is an analogue value, then any positive non-zero value is interpreted as a high.
Power	Output = Input one raised to the power of input two ($In1^{In2}$). For example if input one has the value 4.2, and the value of input two is 3, then output = $4.2^3 = 74.09$ (approx.).
Sqrt	The output is the square root of input one. Input two is not used.

	Log	Log base 10: Output = $\{\text{Log}_{10}(\text{In } 1)\}$. Input two is not used.	
Oper (Cont.)	Ln	Log base e: Output = $\{\text{Log}_n(\text{In } 1)\}$. Input two is not used.	
	Exp	Output = $e^{(\text{input one})}$. Input two is not used.	
	10_x	Output = $10^{(\text{input one})}$. Input two is not used.	
	Sel1	If the Select input is high, input two appears at the output; if the Select input is low, input one appears at the output.	
In1(2) Mul	The scaling factor to be applied to input one (two).		
Units	Allows the user to choose units for the output (see figure 108).		
Resolution	Use the up and down arrows to position the decimal point as required.		
Low Limit	The low limit for all inputs to the function and for the fallback value.		
High Limit	The high limit for all inputs to the function and for the fallback value.		
Fallback	The fallback strategy comes into play if the status of the input value is 'Bad', or if its value lies outside the range (High limit- Low limit).		
	Clip Bad	The output is set to the high or low limit as appropriate; output status is set to 'Bad'.	
	Clip Good	The output is set to the high or low limit as appropriate; output status is set to 'Good'.	
	Fall Bad	The output is set to the fallback value (below); output status is set to 'Bad'.	
	Fall Good	The output is set to the fallback value (below); output status is set to 'Good'.	
	Upscale Bad	The output is set to the high limit and Status is set to 'Bad'.	
	Downscale Bad	The output is set to the low limit and Status is set to 'Bad'.	
	Fallback value	Allows the user to enter the value to which the output is set for Fallback = Fall Good, or Fall Bad.	
	Select	Editable only if Oper = Select. Allows input one or input two to be selected for output.	
In1	Input one value		
In2	Input two value		
Out	The output value resulting from the configured mathematical operation. If either input is 'Bad', or if the result is out of range, the fallback strategy is adopted.		
Status	Indicates the status of the operation as 'Good' or 'Bad'. Used to flag error conditions and can be used as an interlock for other operations.		

Modulator Configuration

This function implements the modulation type firing modes such as fixed and variable period modulation.

NOTE: For the sake of completeness, all Modulator parameters are shown in the figure below. Normally, for the sake of clarity, non-relevant (shaded) parameters should be hidden using the '>Parameter Availability Settings...>Hide Parameters and Lists when Not Relevant' menu item.

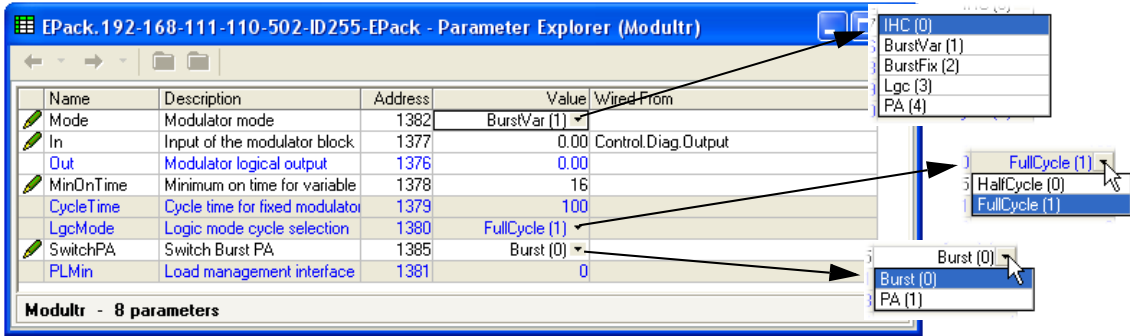

Figure 109 Modulator menu page

Modulator parameters

- Mode** Select the required firing mode from 'Logic', 'PA' (Phase angle) 'Half cycle', 'BurstVar' (Burst firing - minimum on time) or 'Burst-Fix' (Burst firing - cycle time).
- In** This is the value that the modulator is required to deliver.
- Out** The output logic signal controlling the power module on and off times, normally wired to the input of the firing block. For Mode = Phase angle, this is a phase angle demand.
- Min On Time** For Variable Period Modulation, this sets the minimum on time in supply voltage periods. At 50% demand from the modulator, Ton = Toff = Minimum on time, and Cycle time is 2 x Minimum on time = Modulation period. The minimum off time is equal to 'Min on time'.
- Cycle Time** For Fixed Period Modulation, this is the cycle time in supply voltage periods.
- Logic Mode** For Logic Firing Modulation, Half cycle sets firing stop to the next zero crossing; Full cycle sets firing stop at the zero crossing of the next full cycle. Only available in Star with Neutral and Open Delta couplings see [Load Configurations \(page 34\)](#).
- Switch PA** Allows the user to impose Phase Angle firing, overriding the configured Burst Mode as displayed in 'Mode', above.
- PLMin** Not applicable to this software release.

Network Configuration

This identifies the type of electrical network to be controlled, and this, in turn defines how the network's electrical measurements are presented. The configuration is divided into a number of areas:

- Meas
- Setup
- AlmDis
- AlmDet
- AlmSig
- AlmLat,
- AlmAck,
- AlmStop
- AlmRelay

Network Meas Menu

Name	Description	Address	Value	Wired Fron
Frequency	Frequency of the line	267	0.00	
Vline	Line voltage measurement	256	0.00	
Vline2	Line voltage measurement	270	0.00	
Vline3	Line voltage measurement	271	0.00	
I	Irms of the load	257	0.00	
I2	Irms2 of the load	272	0.00	
I3	Irms3 of the load	273	0.00	
Iavg	Average value of Irms	278	0.00	
IsqBurst	Average square value of load current in	258	0.00	
Isq	Square value of the load current	259	0.00	
IsqMax	Maximum squared current in a 3 phase	280	0.00	
IrmsMax	Maximum rms current in a 3 phase netw	282	0.00	
V	Vrms of the load	260	0.00	
V2	Vrms2 of the load	274	0.00	
V3	Vrms3 of the load	275	0.00	
Vavg	Average value of Vrms	279	0.00	
VsqBurst	Average square value of the load voltag	268	0.00	
Vsq	Square value of load voltage	261	0.00	
VsqMax	Maximum squared voltages in the 3 pha	281	0.00	
VrmsMax	Maximum rms voltages in the 3 phase n	283	0.00	
PBurst	True Power measurement in burst firing	262	0.00	
P	True power measurement.	263	0.00	
S	Apparent power measurement	264	0.00	
PF	Power Factor	265	0.00	
Z	Load impedance	266	0.00	
Z2	Load impedance2	276	0.00	
Z3	Load impedance3	277	0.00	
HtSinkTemp	Heatsink 1 temperature	269	0.00	

Network.Meas - 28 parameters

Figure 110 Network, Meas configuration panel

Parameters

This submenu presents power network measurements, according to the network type. All available measurements are listed below, but which values actually appear depends on the network configuration.

- Frequency Displays the calculated frequency of the supply voltage of the power channel associated with this network.
 - Vline Displays 1st phase supply line voltage.
 - Vline2 Displays 2nd phase supply line voltage.
 - Vline3 Displays 3rd phase supply line voltage.
 - I Displays 1st phase load RMS current.
 - I2 Displays 2nd phase load RMS current.
 - I3 Displays 3rd phase load RMS current.
- The time base measurement is the main period in Phase Angle, and the modulation period in Burst Mode.

Iavg	This displays the average current for all three phases; $I_{RMSAvg} = (I_{RMS1} + I_{RMS2} + I_{RMS3})/3$
IsqBurst	Average square value of load current in burst firing. The average Isq in burst firing, the average is taken over the duration of the burst period. This is typically used for monitoring and alarming over the burst period.
Isq	Square value of load current over the mains period in Burst and Phase Angle modes.
IsqMax	The maximum value out of I^2 , I_2^2 , I_3^2 . Used in current limiting and alarm strategies.
IrmsMax	Displays the RMS value of I^2Max measured over the mains period. Typically used for current limiting or current transfer in 3 phase networks, in phase angle mode.
V1	Displays 1st phase load voltage (V_{RMS}).
V2	Displays 2nd phase load voltage (V_{RMS}).
V3	Displays 3rd phase load voltage (V_{RMS}).
	The time base measurement is the main period in phase angle, and the modulation period in burst mode.
Vavg	Displays the average voltage (V_{RMS}), for multi-phase systems.
VsqBurst	Average square value of load voltage in burst firing taken over the duration of the burst period. Typically used for monitoring and alarm strategies over the burst period.
Vsq	Square value of load voltage over the mains period in Burst and Phase Angle modes. Typically used for V^2 control.
VsqMax	Displays the maximum value out of $V1^2$, $V2^2$, $V3^2$. Used in current limiting and alarm strategies.
VrmsMax	The RMS value of V^2 maximum over the mains period. Used for voltage limiting or voltage transfer.
P Burst	Measurement of true power on the network. This is calculated over the modulation period in Burst Firing mode. Typically used for monitoring and alarm strategy.
P	True power measurement over the mains period in Burst and Phase Angle modes. Typically used for true power control.
S	Apparent power measurement. For phase angle firing $S=V_{line} \times I_{RMS}$; for burst firing $S=V_{RMS} \times I_{RMS}$
PF	Calculation of power factor. Defined as Power Factor = True Power / Apparent Power. In phase angle this is $PF=P/S$; in burst firing $PF = PBurst/S = \cos\phi(Load)$
Z1	Displays 1st phase load impedance.
Z2	Displays 2nd phase load impedance.
Z3	Displays 3rd phase load impedance.
	Defined as: $Z=V_{rms}/I_{rms}$. Measurement uses line current and load voltage.
HSink Temp	Reserved for future development.

Network Setup configuration

This displays the setup of the network and associated functions.

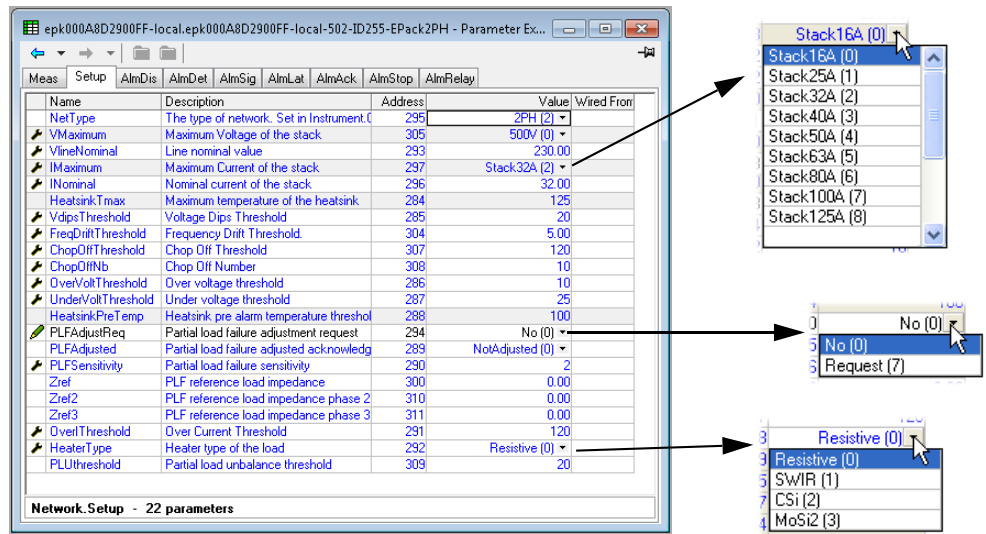

Figure 111 Network setup menu page

Parameters

- NetType** The type of network to which the unit can be connected. This is set at the factory and cannot be changed
- VMaximum** Indicates the maximum voltage (physical rating) of the stack (500V)
- Vline Nominal** Line voltage nominal value (Line to neutral)
- IMaximum** Indicates the maximum current of the stack (16A, 25A, 40A, 63A, 100A, 125A). Further values are reserved for future development.
- INominal** Nominal current supplied to the load (limited by IMaximum).
- VLoadType** Defines the computation method for load voltage (Vload).
 0: Vload = Vline as long as I > Ithreshold (internal definition)
 1: Compute Vload using the formula $V^2load = P^2 / I^2$.
- Heatsink Tmax** Reserved for future development.
- VdipsThreshold** Voltage dips threshold. This is a percentage difference (relative to Vline Nominal) between 2 consecutive half cycles. Each half cycle voltage measurement is integrated and at the end of each half cycle the last two voltage integrals are compared.
- FreqDriftThold** The supply frequency is checked every half cycle, and if the percentage change between 1/2 cycles exceeds this threshold value, a Mains Frequency System Alarm is generated. The threshold may be set to a maximum of 5% to cater for the effects of heavily inductive networks.
- ChopOffThreshold** The 'Chop-off' alarm becomes active if load current exceeds this threshold for more than a pre-defined number of mains periods (Number Chop Off parameter). Threshold values lie between 100% and 400% of the unit's nominal current (INominal).
- NumberChopOff** Definition of the number of mains periods in which Chop Off events can occur before a Chop Off alarm is enabled. Only used with Chop Off Threshold .
- OverVoltThreshold** The threshold for detecting an over voltage condition as a percentage of VLineNominal. If Vline rises above the threshold an OverVolt alarm is set.
- UnderVoltThreshold** This is the threshold for detecting an under voltage condition as a percentage of VLineNominal. If Vline falls below the threshold an UnderVolt alarm is set

Heatsink PreTemp	Reserved for future development.
PLFAdjustReq	Partial load failure adjustment request. To make the Partial Load Failure (PLF) alarm operate correctly, the normal steady-state condition must be known to the instrument. This is done by activating the PLF Adjust Req once the controlled process has achieved a steady state condition. This causes a load impedance measurement to be made which is used as a reference for detecting a partial load failure. If the load impedance measurement is successful PLFAdjusted (below) is set. The measurement fails if the load voltage (V) is below 30% of (VNominal) or the current (I) is below 30% of (INominal). The PLF alarm becomes active as setup in 'PLF Sensitivity', below.
PLFAdjusted	Partial load failure adjusted acknowledge. Indicates that the user requested a PLF adjustment and that the adjustment was successful.
PLFSensitivity	Partial load failure sensitivity. This defines how sensitive the partial load failure detection is to be as the ratio between the load impedance for a PLFadjusted load and the current impedance measurement. For example for a load of N parallel, identical elements, if the PLF Sensitivity (s) is set to 2, then a PLF alarm will occur if N/2, or more elements are broken (i.e. open circuit). If PLF Sensitivity is set to 3, then a PLF alarm occurs if N/3 or more elements are broken. If (N/s) is non-integer, then the sensitivity is rounded up. E.G. if N = 6 and s= 4, then the alarm is triggered if 2 or more elements are broken.
Zref	Reference load impedance, as measured when PLF adjust is requested.
OverIThreshold	The threshold for detecting an over current condition as a percentage of INominal. If I is above the threshold a Mains Current Alarm occurs (DetoverCurrent).
HeaterType	Shows the type of heater used in the load as: 'Resistive', 'SWIR' (Short wave infra-red), 'CSi' (Silicon Carbide), 'MoSi2' (Molybdenum Disilicide).
PLUthreshold	Partial load unbalance threshold. Defines the threshold for detecting a partial load unbalance condition. This is only applicable to a three phase system. This occurs when the difference between the maximum and minimum current of the three phase system exceeds the threshold as a percentage of INominal. The alarm can be detected between 5 and 50%.

Network Alarms

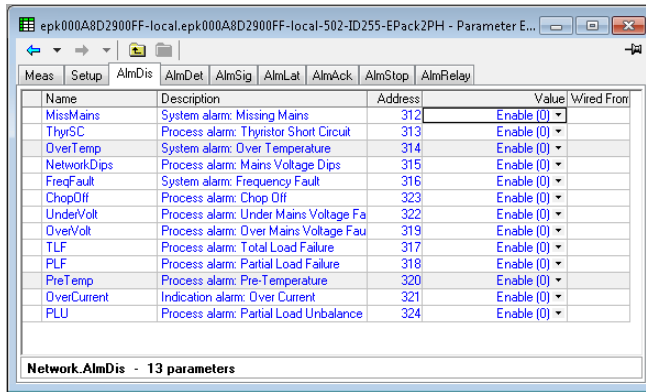

Figure 112 Network alarms page

AlmDis

This menu allows individual network block alarms (listed below) to be enabled/disabled.

- | | | |
|-------------------------------|-----------------------|------------------------------|
| Missing Mains | Mains frequency fault | Total load failure |
| Thyristor short circuit | Chop Off | Partial load failure |
| Over-temperature ¹ | Under voltage | Pre-temperature ¹ |
| Mains voltage (Network) dips | Over voltage | Over current |
| PLU (Partial Load Unbalance) | | |

1. Reserved for future development

Network AlmDet Submenu

As for 'Alarm Disable', above, but this Alarm detect submenu indicates whether any of the network alarms has been detected and is currently active.

Network Almsig Submenu

These displays show whether an alarm has occurred and also contains latching information. The relevant AlarmSig parameter is used when wiring (to a relay for example). The alarm list is as given above.

Network AlmLat Submenu

As for 'Alarm Disable', above, but this Alarm Latch submenu allows each individual network block alarm to be defined as latching or non-latching.

Network AlmAck Submenu

As for 'Alarm Disable', above, but this Alarm Acknowledge submenu allows each individual network block alarm to be acknowledged. Once acknowledged, the associated signalling parameter is cleared. Acknowledge parameters automatically clear after being written.

NOTE: Alarms may not be acknowledged whilst the trigger source is still active.

Network Almstop Submenu

Allows each individual alarm type to be configured to stop the related power module from firing. Activated by the related Signalling parameter. The alarm list is as given above.

Network Almrelay Submenu

Allows each individual alarm to be selected to activate (or not) the relay.

NOTE: When utilising Almrelay function ensure FaultDet/CustomAlarm parameter remains wired to IO.Relay/PV.

Qcode

Quick code parameters, settable when in Quickcode configuration mode as well as here.

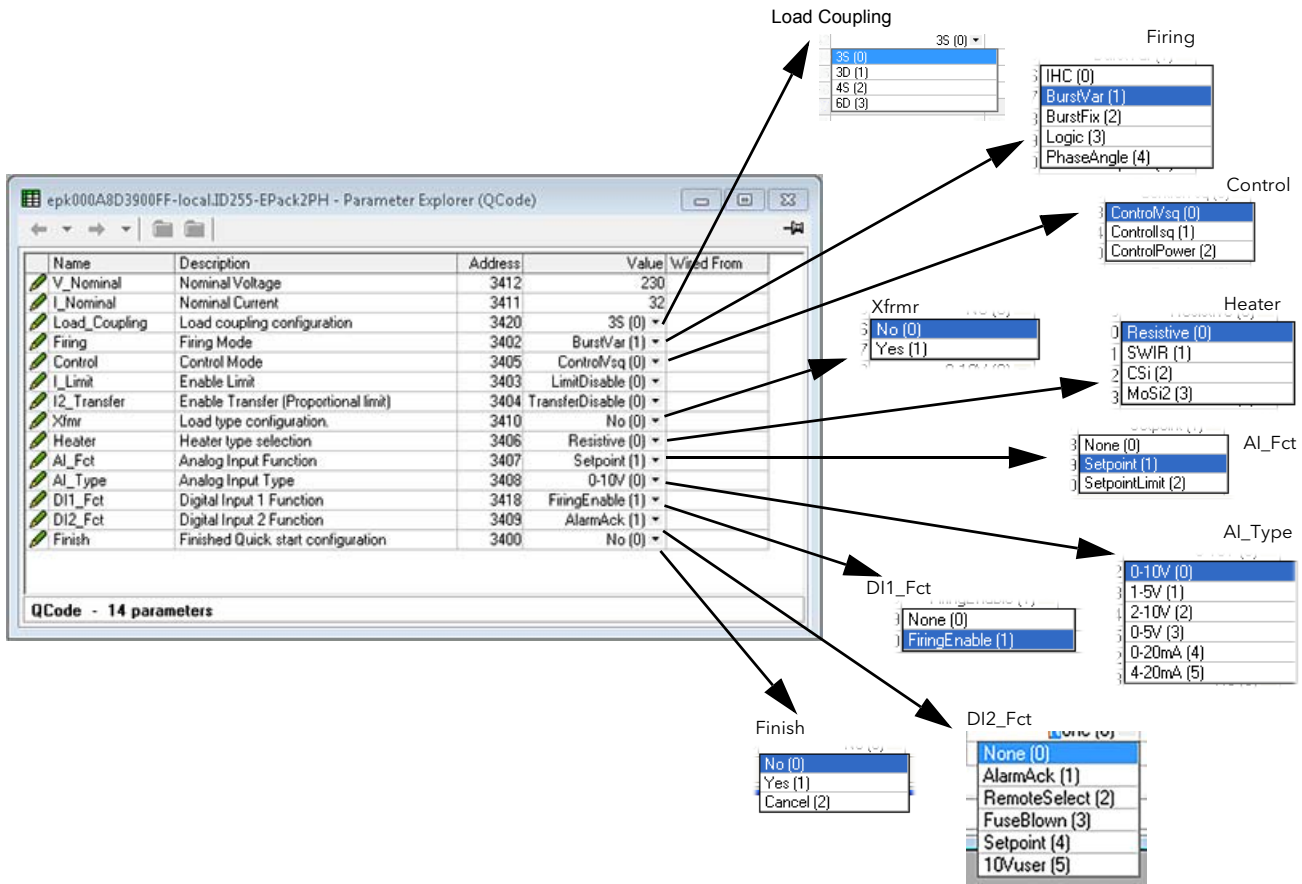

Figure 113 Quick code parameters

Parameters

- V_Nominal The nominal output voltage to be supplied.
- I_Nominal The nominal output current expected to be drawn.
- Firing Select firing mode from IHC (Intelligent half cycle), Burst firing (fixed or variable), Logic or Phase angle.
- Load Coupling For two phase systems only, this allows the user to select one of the following wiring configurations:
3 Delta (3D) or 3 Star (3S)
- Control Select 'Vsq' (V²), 'Isq' (I²), or 'Power' as the control mode.
- I_Limit Enable or disable threshold limit. (By default the current limit function is enabled).
- I2_Transfer Enable or disable transfer (Proportional limit).
- XFmr Select output as suitable for resistive loads (No) or for transformer primary loads (Yes).
- Heater Select Resistive, Short wave infra red (SWIR), Silicon carbide (CSi) or Molybdenum disilicide (MoSi2) as the heating element type.
- AI_Fct Select the Analogue Input function as 'None', 'Setpoint' or 'Setpoint limit'.
- AI_Type Select the required Volt or mA range (as shown above) for the analogue input.
- DI1_Fct Select the funtion of Digital Input 1 as 'None' or 'Firing Enable'.
- DI2_Fct Select the funtion of Digital Input 2 as;

	'None', Alarm acknowledge ('AlarmAck'), Select remote setpoint ('RemoteSelect') or Fuse Blown ('FuseBlown), or Setpoint, providing Firing is set too 'Logic', and AI_Type is not set too 'Setpoint', or a configurable User Input ('10Vuser').
Finish	Yes = quit quick code (after confirmation) and restart the unit with the new configuration; No = continue configuration editing; Cancel = ignore all changes and restart the unit with the previous (unedited) configuration.
Refresh	Refresh quick code parameters.

Setprov Configuration Menu

The Setpoint provider supplies one local and two remote setpoints. It also allows users to manage a setpoint ramp, a setpoint limit (re-linearization) and the possibility to select between percentage and engineering for setpoint unit.

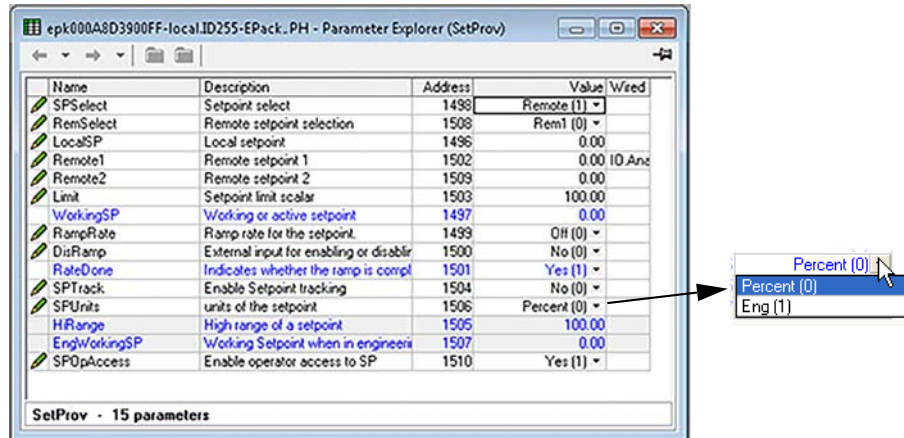

Figure 114 SetProv configuration page

Setpoint provider parameters

- SPSelect** Allows the user to select between Remote or Local as the setpoint source.
- RemSelect** Select Remote1 or Remote2 as the remote setpoint.
- LocalSP** Allows entry of a setpoint value to be used when SPSelect (above) is set to 'Local'.
- Remote1** The Remote setpoint value (normally wired from an analogue input) for use when SPSelect = Remote and RemSelect = Remote1.
- Remote2** The Remote setpoint value (normally wired from an analogue input) for use when SPSelect = Remote and RemSelect = Remote2.
- Limit** Allows the target setpoint to be scaled such that 'scaled target SP' = (target SP x limit)/100. Thus, when limit = 100, the setpoint is unscaled.
- WorkingSP** The active value being provided as a setpoint output. This might be the current target setpoint or the rate-limited target setpoint.
- RampRate** This applies a rate limit to the working setpoint, until the target setpoint has been achieved. The 'RateDone' parameter (below) is set to 'No' for the duration of the rate limiting, then set to 'Yes' when rate limiting is complete.
- DisRamp** This is an external control used to enable/disable ramp rate limiting and to write the target setpoint directly to the working setpoint. The 'RateDone' parameter (below) is set to 'Yes' when DisRamp is 'Yes'.
- RateDone** Set to 'No' if ramp rate limiting (above) is in operation. Otherwise set to 'Yes'.
- SPTrack** If enabled ('Yes') the local setpoint tracks the remote setpoints, so that if the setpoint is subsequently set to 'Local', the local setpoint will be the same as the last known value of the remote setpoint, thus ensuring a bumpless transfer.
- SPOpAccess** The SetPoint operational access parameter is used to allow or hide access to a local setpoint.
 Yes (1) = Enables access.
 No (0) = Disables (hides) access.
 Setpoint remains adjustable from a remote input whatever value of this parameter

SPUnits	Allows the user to select % or 'Eng' (Engineering units) as Setpoint units. If 'Eng' is selected, 'HiRange' and 'Eng workingSP' appear at the user interface.
HiRange	Appears only if SP units set to 'Eng'. This value is the high range of the setpoint used to scale the setpoint into % of High Range.
EngWorkingSP	Appears only if SP units set to 'Eng'. This value is an indication of the working setpoint in Engineering units. The parameter must not be used for control because control loops accept setpoints only as % values.

Timer Configuration

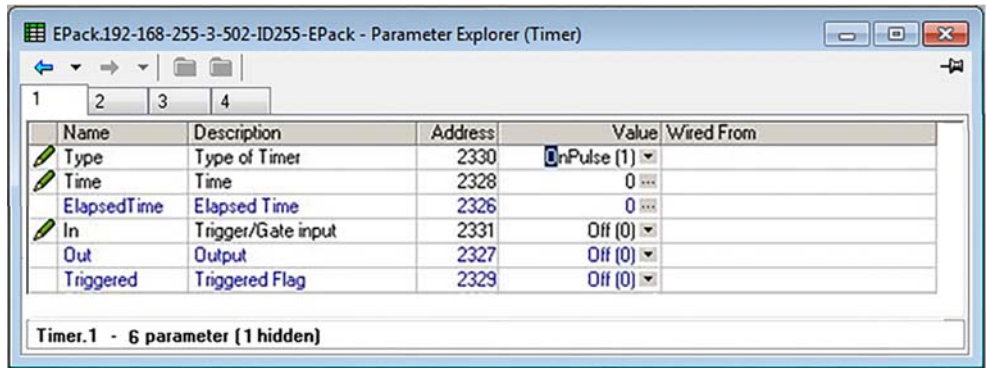

Figure 115 iTools Timer configuration

Parameters

Type	Allows the user to select the required timer type as follows:
Off	Timer is off
On Pulse	The timer output switches on when 'In' changes from Off to On, and it remains on until the time period ('Time' - see below) has elapsed. If the input is re-triggered before 'Time' has elapsed, the timer re-starts. 'Triggered' (below) follows the state of the output.
On delay	After the input changes from Off to On, the timer output remains off until the time period defined in 'Time' (below) has elapsed. Once this period has elapsed, if the input is still on, the output switches on and remains on until the input goes Off. Elapsed time is set to zero when the input goes off. 'Triggered' follows the state of the input.
One Shot	If the input is On, then as soon as a value is entered into the 'Time' parameter (below) the output goes on, and remains on until the Time period has elapsed, or the input goes off. If the input is off, the output is set off and the time count-down is inhibited until input goes on again. 'Triggered' goes On as soon as the time value is edited, and remains on until the output goes Off. The Time value may be edited whilst active. Once the time period has elapsed, the Time value must be re-edited in order to re-start the timer.
Min On	The output remains 'On' as long as the Input is on, plus the 'Time' period (below). If the input returns to the on state before the time period has elapsed, the elapsed time is reset to zero, so that the full time period is added to the On period when the input switches off again. 'Triggered' is On whilst the elapsed time is greater than zero.
Time	Allows the user to set a time period for use as described in 'Type' above. Initially, the display is in the form Minutes:seconds.10ths of seconds, but as the input value increases the format changes first to Hours:Mins:Secs, then to Hrs:Mins. (Holding the up arrow key continuously operated causes the speed at which the value increments to increase. Minimum entry is 0.1 seconds; maximum is 500 hours.
Elapsed Time	Shows how much of the time period has passed so far.
In	The timer trigger input. The function of this input varies according to timer type, as described above.
Out	Shows the timer on/off status.
Triggered	Function depends on timer type, as described above.

Timer examples

Figure 116 shows some timing examples for the different types of timer available.

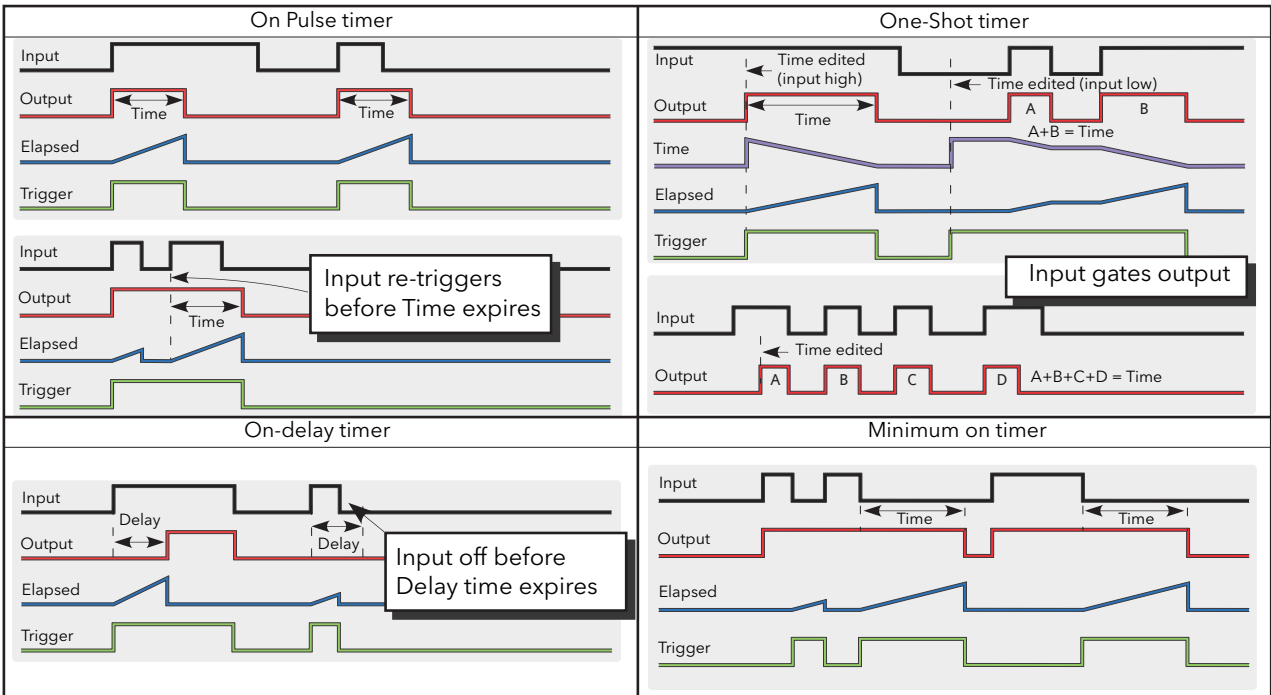

Figure 116 Timer examples

Totaliser Configuration

The totaliser is an instrument function used to calculate a total quantity by integrating a flow rate input over time. The maximum value of the totaliser is +/- 99999. The outputs from a totaliser are its integrated value, and an alarm state.

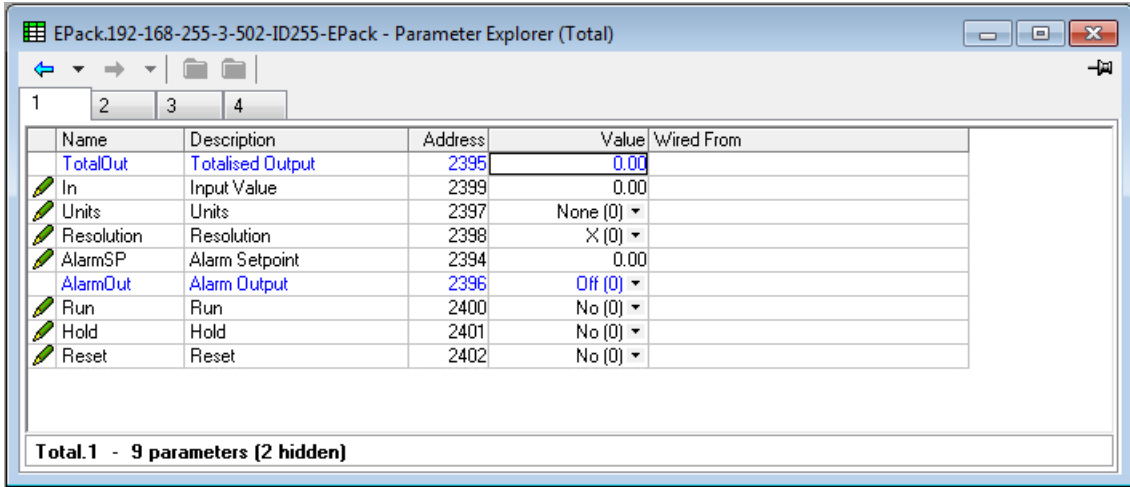

Figure 117 iTools Totaliser page

Parameters

- Total Out The integrated total between -10¹⁰ and +10¹⁰ (i.e. ± 10,000,000,000)
- In The parameter to be totalised.
- Units Units of the totalised measurement.
- Resolution Set the number of decimal places for the totaliser value.
- AlarmSP Totaliser alarm setpoint. This threshold is applied to the totalised measurement. When totalising positive values, a positive AlarmSP value must be entered; the totaliser alarm being triggered when the totaliser value reaches or exceeds AlarmSP. When totalising negative values, a negative value must be entered; the totaliser alarm being triggered when the totaliser value reaches or goes more negative than AlarmSP. If set to zero, the alarm is disabled.
- AlarmOut The on/off status of the totaliser alarm.
- Run Yes initiates integration; No inhibits integration.
- Hold Yes suspends integration; No restarts integration.
- Reset Yes resets the totaliser value to zero and resets the totaliser alarm.

User Value Configuration Menu

This provides storage for up to four user-defined constants. Typical uses are as a sources for maths functions, or as storage for values written over the communications link.

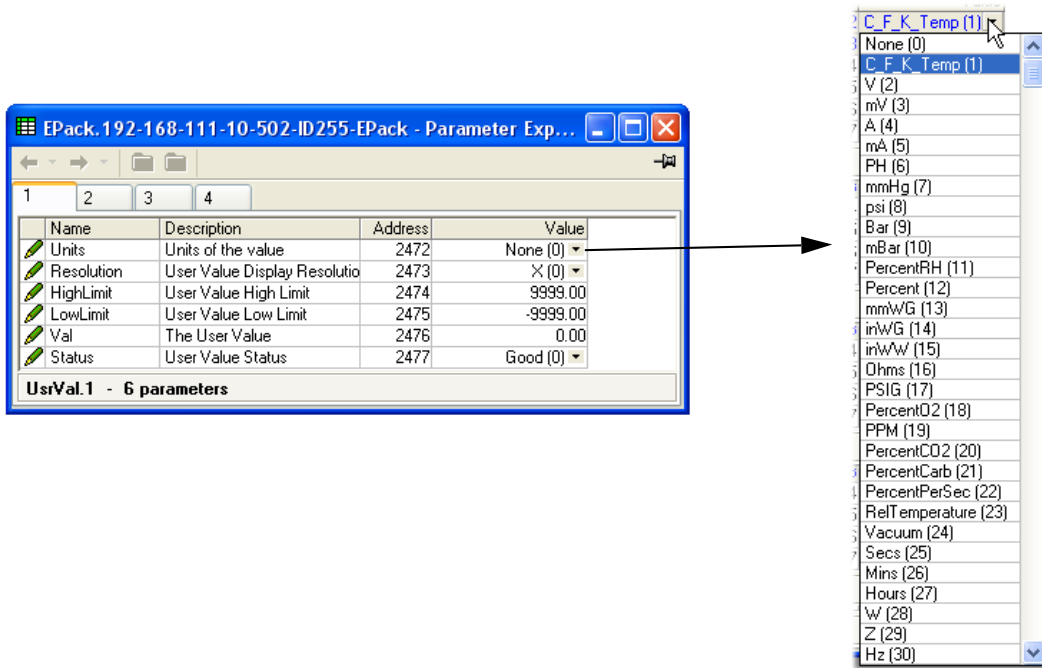

Figure 118 Top level UseVal page

User Value parameters

- Units** Allows the selection of User value units.
- Resolution** Set the number of decimal places for the User Value value.
- High/Low Limit** Allows the user to set limits to prevent the user value from being set out-of-bounds.
- Value** Allows the user to enter a value, or the value if wired to a suitable parameter.
- Status** If this parameter is wired, it can be used to force a Good or Bad status onto the User Value for test purposes (e.g. fallback strategy). If not wired, it reflects the status of the Value input if this input is wired.

Using iTools

iTools software running on a pc allows quick and easy access to the configuration of the unit. The parameters used are the same as those described in "Configuration using iTools" on page 106, with the addition of various diagnostic parameters.

iTools also gives the user the ability to create software wiring between function blocks, something that is not possible from the operator interface. Such wiring is carried out using the Graphical wiring Editor feature.

In addition to the guidance given here, there are two on-line Help systems available within iTools: Parameter help and iTools help. Parameter help is accessed by clicking on 'Help' in the toolbar (opens the complete parameter help system), by right-clicking on a parameter and selecting 'Parameter Help' from the resulting context menu, or by clicking on the Help menu and selecting 'Device Help'. iTools help is accessed by clicking on the Help menu, and selecting 'Contents'. iTools help is also available in manual format under part number HA028838, either as a physical manual or as a pdf file.

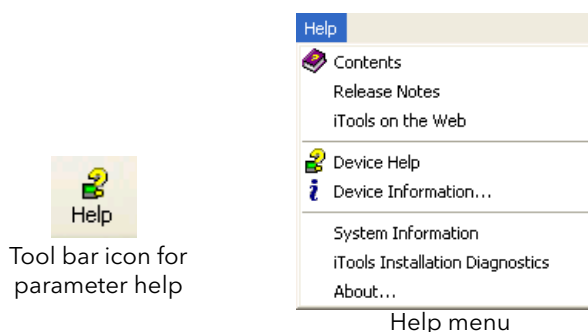

Figure 119 Help access

iTools connection

Automatic detection

The following descriptions assume that the latest version iTools software has been correctly installed on the pc.

For EPack units only (at time of publication), if the desktop/laptop and EPack are IP compatible (same subnet mask) then, Plug & Play allows easy connection as follows.

1. Set correct IP mode and or IP address to the instrument and Personal Computer.
2. Launch iTools, click on the button 'Add' a popup window appears showing you all EPack instruments on the network.
3. Double click on one or more units to add them to iTools.

NOTE: 'Eurotherm discovery' mechanism is based on 'Zero Configuration Networking' which is generic name used to group protocols together in order to create communication networks automatically (Plug & Play)

Alternatively, if there is a mix of EPack and other instruments on the network, the following procedure can be used.

Ethernet (Modbus TCP) communications

NOTE: The following description is based on windows XP. Windows 'Vista' is similar.

It is first necessary to determine the IP address of the unit, as described in "Communications Configuration" on page 110. This can be done from either the Config or Quickcode menu.

Once the Ethernet link has been correctly installed, carry out the following actions at the pc:

1. Click on 'Start'
2. Click on 'Control Panel'. (If Control Panel opens in 'Category View' select 'Classic View' instead.)
3. Double-click on 'iTools'.
4. Click on the TCP/IP tab in the Registry settings configuration.
5. Click on Add... The 'New TCP/IP Port' dialogue box opens.
6. Type-in a name for the port, then click Add...
7. Type the IP address of the unit in the 'Edit Host' box which appears. Click OK.
8. Check the details in the 'New TCP/IP Port' box, then click on 'OK'.
9. Click on 'OK' in the 'Registry settings' box to confirm the new port.)

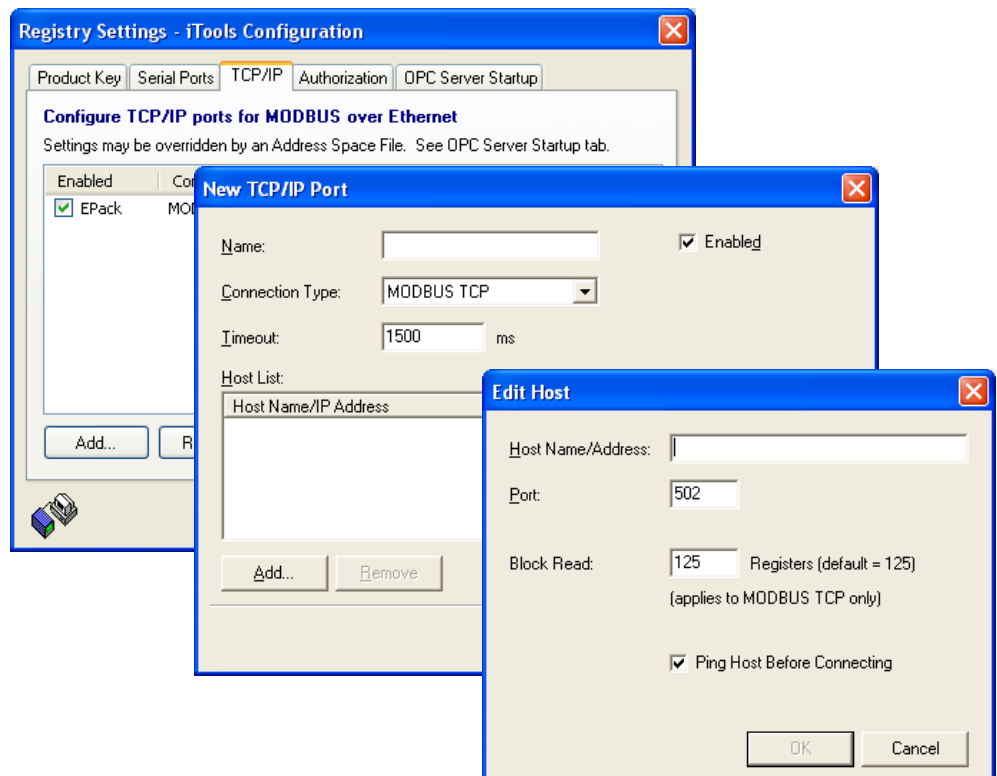

Figure 120 Adding a new Ethernet port

To check that the pc can now communicate with the instrument, Click 'Start', 'All Programs', 'Accessories', 'Command Prompt', when the Command Prompt box appears, type in : Ping<Space>IP1.IP2.IP3.IP4<Enter> (where IP1 to IP4 are the IP address of the instrument).

If the Ethernet link to the instrument is operating correctly, the 'successful' reply arrives. Otherwise, the 'failed' reply arrives, in which case, the Ethernet link, IP address, and pc port details should be verified.

```
CA Command Prompt
Microsoft Windows XP [Version 5.1.2600]
(C) Copyright 1985-2001 Microsoft Corp.

C:\Documents and Settings\richardne>Ping 123.123.123.1

Pinging 123.456.789.0 with 32 bytes of data:

Reply from 123.123.123.1: bytes=32 time=1ms TTL=64
Reply from 123.123.123.1: bytes=32 time=1ms TTL=64
Reply from 123.123.123.1: bytes=32 time=1ms TTL=64
Reply from 123.123.123.1: bytes=32 time=1ms TTL=64

Ping statistics for 123.123.123.1:
    Packets: Sent = 4, Received = 4, Lost = 0 (0% loss),
    Approximate round trip times in milli-seconds:
        Minimum = 0ms, Maximum = 1ms, Average = 0ms

C:\Documents and Settings\richardne>
```

```
CA Command Prompt
Microsoft Windows XP [Version 5.1.2600]
(C) Copyright 1985-2001 Microsoft Corp.

C:\Documents and Settings\richardne>Ping 123.123.123.1
Ping request could not find host 123.123.123.1. Please check the name and try again.

C:\Documents and Settings\richardne>_
```

Figure 121 Command prompt 'Ping' screens (typical)

Once the Ethernet link to the instrument has been verified, iTools can be started (or shut down and restarted), and the Scan toolbar icon used, to 'find' the instrument. The scan can be stopped at any time by clicking on the Scan icon a second time.



See "Scanning for Instruments" on page 166 for more details of the scan procedure.

Direct Connection

This section describes how to connect a pc directly to a Driver Module which, for this purpose, must be fitted with the Ethernet communications option.

WIRING

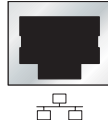

PC Ethernet connector.

Connection is made from the Ethernet connector on the front of the Driver Module to an Ethernet RJ45 connector, usually located at the rear of the pc.

Once wired correctly, and powered up, it is necessary to enter a suitable IP address and subnet mask into the Comms configuration. This information can be found as follows:

1. At the pc, click 'Start'. 'All Programs', 'Accessories', 'Command Prompt'
2. When the Command Prompt box appears, type in :IPConfig<Enter>
3. The response is a display, such as that shown below, giving the IP address and Subnet mask of the pc.
Choose an address in the range covered by these two values.
4. A subnet mask element of 255 means that the equivalent element of the IP address must be used unchanged. A subnet mask element of 0 means that the equivalent element of the IP address may take any value between 1 and 255 (0 is not allowed). In the example below, the range of IP addresses which may be chosen for the Driver Module is 123.123.123.2 to 123.123.123.255. (123.123.123.0 is not allowed and 123.123.123.1 is the same as the pc's address, and may therefore not be used.)

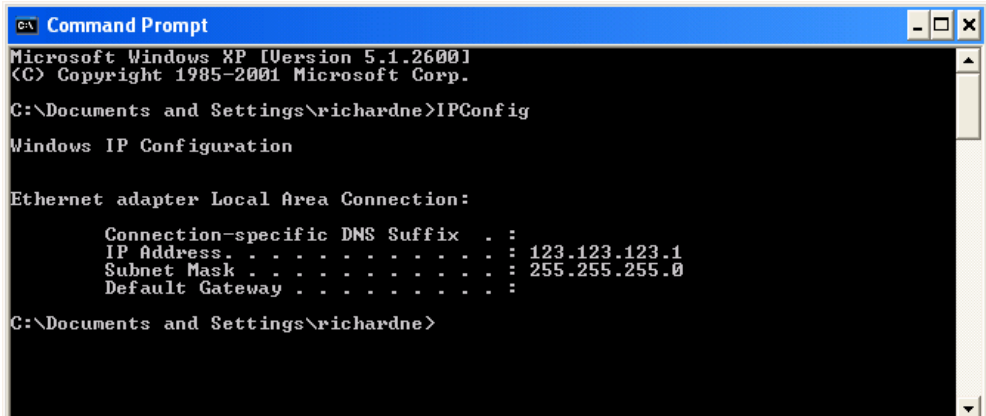

Figure 122 IP Config command

5. In Comms configuration (see page 110), enter the selected IP address and the subnet mask (as it appears in the command prompt window) in the relevant parts of the configuration menu.
6. Check communications by 'pinging' as described in Ethernet (Modbus TCP) communications (page 162), above.

Once the link to the instrument has been verified, iTools can be started (or shut down and re-started), and the 'Add' button used to add the instrument. Alternatively, the Scan toolbar icon can be used, to 'find' the instrument. The scan can be stopped at any time by clicking on the Scan icon a second time.



See [Scanning for Instruments \(page 166\)](#), for more details of the scan procedure.

Subnet Masks and IP addresses.

Subnet Masks are most readily understood when looked at in binary format. For example, a mask of 255.255.240.10 can be re-written as: 11111111.11111111.11110000.00001010. In such a case, IP addresses 11111111.11111111.1111xxx.xxx1x1x would be recognised (where x can be either a 0 or a 1).

Subnet mask	1	1	1	1	1	1	1	1	1	1	1	1	1	1	1	1	1	1	1	1	0	0	0	0	0	0	0	1	0	1	0
IP addresses (Binary)	1	1	1	1	1	1	1	1	1	1	1	1	1	1	1	1	1	1	1	1	x	x	x	x	x	x	x	1	x	1	x
IP addresses (decimal)	255							255							240 to 255				10, 11, 14, 15, 26, 27, 30, 31, 42, 43, 46, 47 etc.												

Scanning for Instruments

Clicking on the 'Scan' toolbar icon causes a dialogue box (shown below) to appear. This allows the user to define a search range of addresses.

NOTES:

1. Scanning is necessary only when the 'Plug & Play' is not available for the instrument type being searched for.
2. E-Pack units with software version 2.03 onwards, answer to any request made to their IP addresses independently of any Modbus address setting.
3. The default selection (Scan all device addresses...) will detect any instrument on the serial link, which has a valid address. The 'Scan for Eurotherm devices only' and 'Terminate Scan when first device found' tick boxes can be used to modify the scan process.

As the search progresses, any instruments detected by the scan appear as thumbnails (faceplates) in the 'Panel Views' area, normally located at the bottom of the iTools screen. (options/Panel Views position allows this area to be moved to the top of the window, or the Close icon  can be used to close it. Once closed it can be re-opened by clicking on 'Panel Views' in the 'View' menu.)

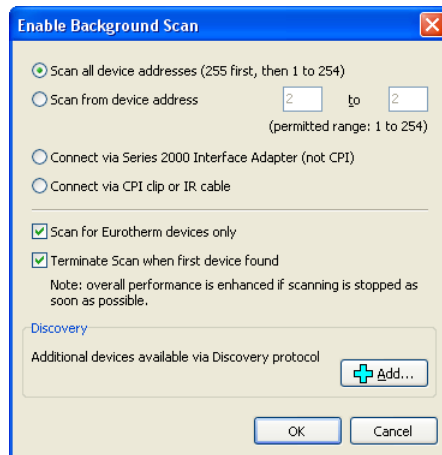

Figure 123 Scan range enable

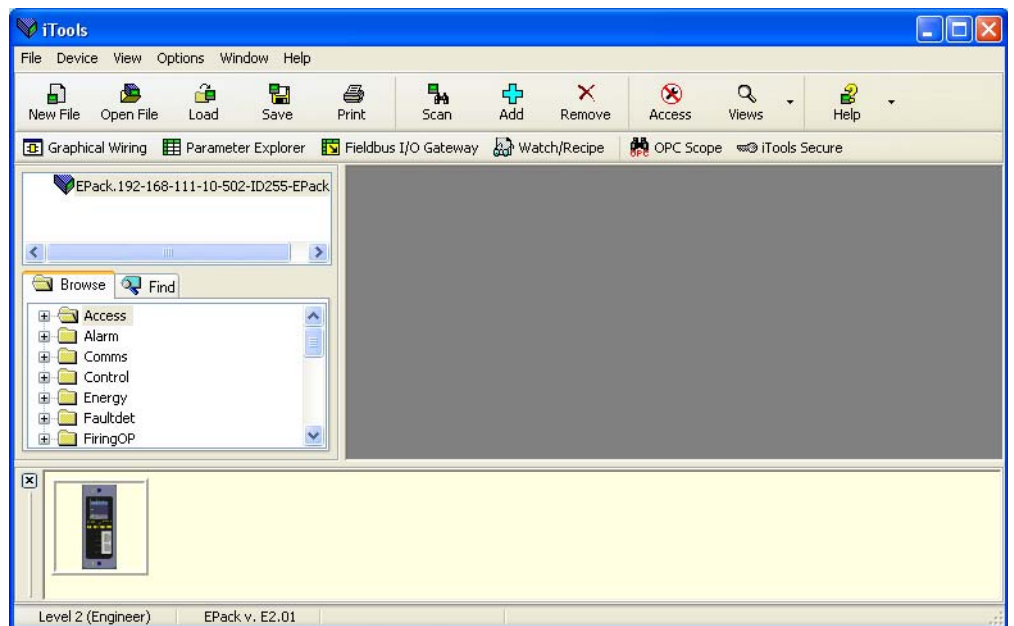

Figure 124 iTools initial window with one instrument detected

Graphical Wiring Editor Graphical Wiring

NOTE: The Graphical wiring editor is a chargeable option, and the toolbar icon appears only if the option has been purchased and is enabled.

Clicking on the Graphical Wiring Editor (GWE) toolbar icon causes the Graphical wiring window for the current instrument configuration to open. Initially, this reflects the preset factory default block wiring.

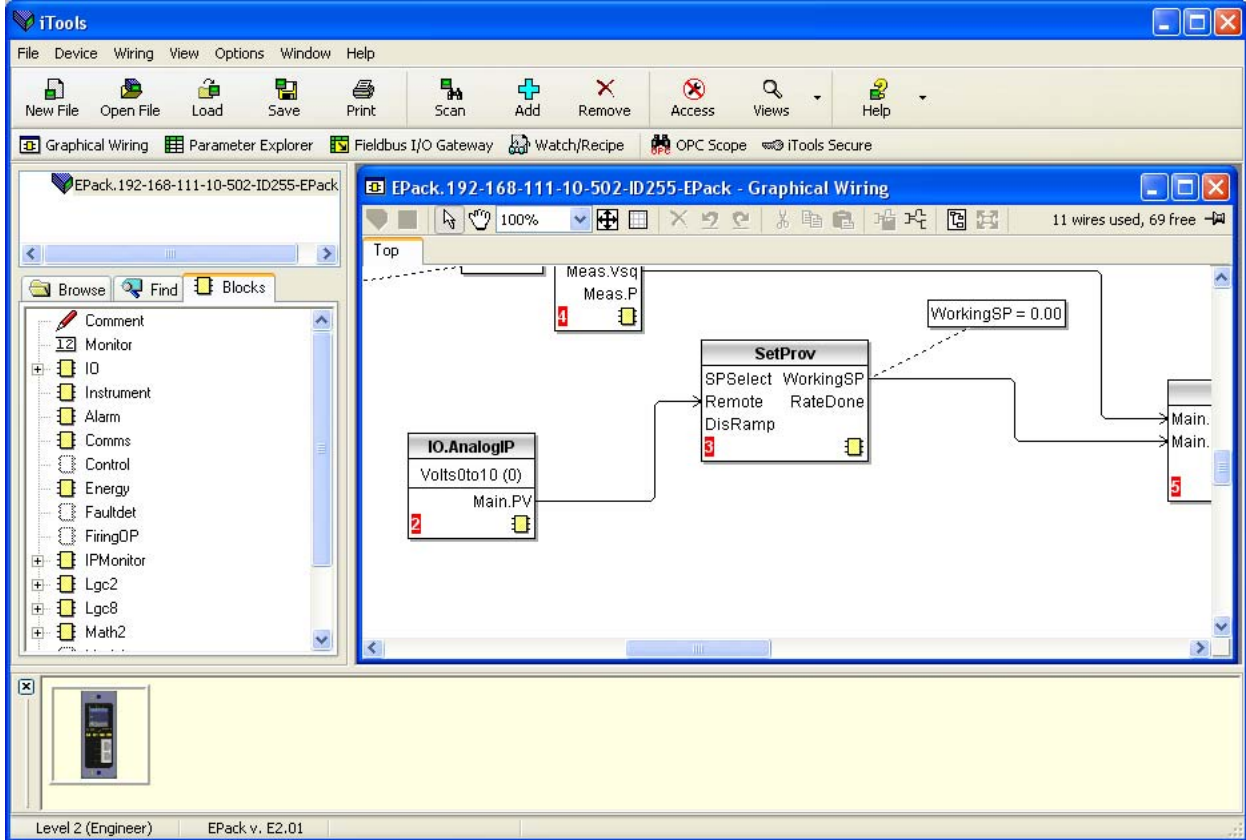
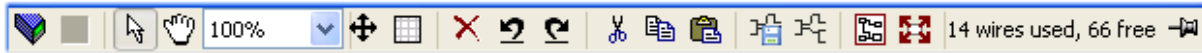

Figure 125 Graphical wiring Editor

The graphical wiring editor allows:

1. Function blocks, notes, comments etc. to be 'drag and dropped' into the wiring diagram from the tree list (left pane).
2. Parameters to be wired to one another by clicking on the output, the clicking on the required input.
3. Viewing and/or editing of parameter values by right-clicking on a function block and selecting 'Function Block View'.
4. The user to select parameter lists and to switch between parameter and wiring editors.
5. Completed wiring to be downloaded to the instrument (function blocks and wiring items with dashed outlines are new, or have been edited since the last download).

Toolbar



	Download wiring to Instrument.
	Mouse Select. Select normal mouse operation. Mutually exclusive with 'Pan', below.
	Mouse Pan. When active, this causes the mouse cursor to become a hand-shaped icon. Allows the graphical wiring diagram to be click-dragged within the GWE window aperture.
	Zoom. Allows the magnification of the wiring diagram to be edited.
	Pan tool. Whilst left-clicked, the cursor appears as a rectangle, representing the position of GWE window aperture over the whole wiring diagram. Click dragging allows this aperture to be moved freely about the diagram. Rectangle size depends on Zoom (magnification) factor.
	Show/Hide grid. This icon toggles a background alignment grid on and off.
	Undo, Redo. Allows the user to undo the last action, or once an undo action has taken place, to undo the undo. Short cuts are <Ctrl>+<Z> for undo; <Ctrl>+<R> for re-do.
	Cut, Copy, Paste. Normal Cut (copy and delete), Copy (copy without delete) and Paste (insert into) functions. Short cuts are <Ctrl>+<X> for cut; <Ctrl>+<C> for copy and <Ctrl>+<V> for Paste.
	Copy diagram fragment; Paste diagram fragment. Allows a part of the wiring diagram to be selected, named and saved to file. The fragment may then be pasted into any wiring diagram, including the source diagram.
	Create compound; Flatten compound. These two icons allow compounds to be created and 'uncreated' respectively.

Wiring editor operating details

Component Selection

Single wires are shown with boxes at 'corners' when selected. When more than one wire is selected, as part of a group, the wire colour changes to magenta. All other items have a dashed line drawn round them when selected.

Clicking on a single item selects it. An Item can be added to the selection by holding down the control key (ctrl) whilst clicking on the item. (A selected item can be deselected in the same way.) If a block is selected, then all its associated wires are also selected.

Alternatively, the mouse can be click-dragged on the background to create a 'rubber band' round the relevant area; anything within this area being selected when the mouse is released.

<Ctrl>+<A> selects all items on the active diagram.

Block Execution Order

The order in which the blocks are executed by the instrument depends on the way in which they are wired. The order is automatically worked out so that the blocks use the most recent data. Each block displays its place in its sequence in a coloured square in the bottom left-hand corner (figure 126).

Function Blocks

A Function Block is an algorithm which may be wired to and from other function blocks to make a control strategy. Each function block has inputs and outputs. Any parameter may be wired from, but only parameters that are alterable in Operator Mode may we wired to. A function block includes any parameters that are needed to configure or operate the algorithm. The inputs and outputs which are considered to be of most use are always shown. In most cases all of these need to be wired before the block can perform a useful task.

If a function block is not faded in the tree (left hand pane) it can be dragged onto the diagram. The block can be dragged around the diagram using the mouse.

A Maths block is shown below as an example. When block type information is alterable (as in this case) click on the box with the down arrow in it to display a dialogue box allowing the value to be edited.

If it is required to wire from a parameter, which is not shown as a recommended output, click on the 'Click to Select Output' icon in the bottom right hand corner to display a full list of parameters in the block (figure 128, below). Click on one of these to start a wire.

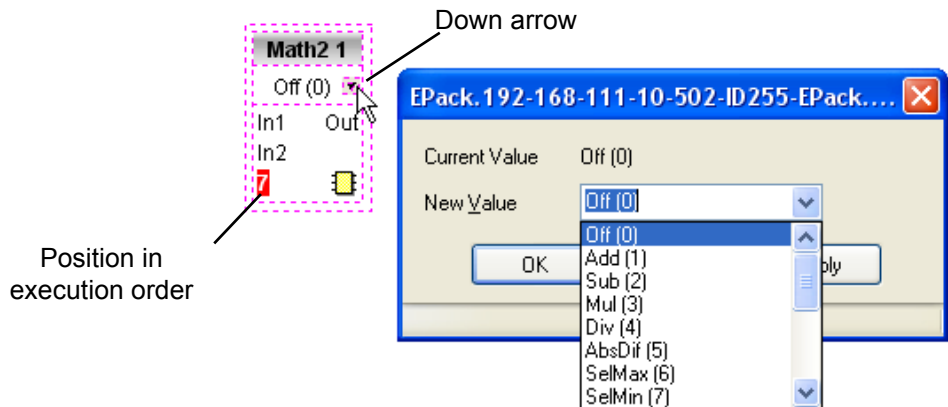

Figure 126 Function block example

Function Block context menu

Right click in the function block to display the context menu.

Function block View Displays a list of parameters associated with the function block. 'Hidden' parameters can be displayed by de-selecting 'Hide Parameters and Lists when not Relevant' in the Options menu 'Parameter availability Settings...' item.

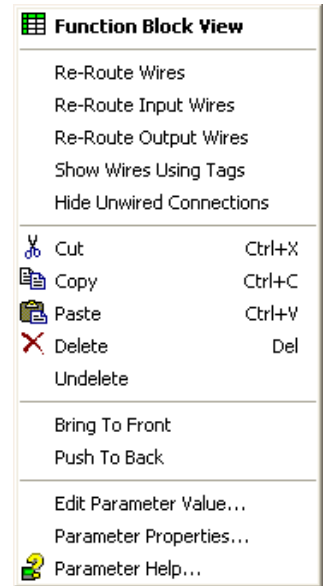
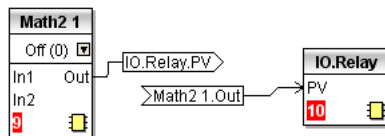

Figure 127 Function block context menu

Re-Route wires Redraws all wiring associated with the function block.
Re-Route Input wires Redraws all Input wiring associated with the function block.
Re-Route Output wires Redraws all Output wiring associated with the function block.
Show Wires Using Tags Wires are not drawn, but their Start and End destinations are indicated by tags instead. Reduces wire 'clutter' in diagrams, where source and destination are widely separated.



Hide Unwired Connections

Displays only those parameters which are wired.

Cut Allows one or more selected items to be moved to the Clipboard ready for pasting into another diagram or compound, or for use in a Watch window, or OPC scope. The original items are greyed out, and function blocks and wires are shown dashed until next download, after which they are removed from the diagram. Short cut = <ctrl>+<X>. Cut operations carried out since the last download can be 'undone' by using the 'Undo' toolbar icon, by selecting 'Undelete' or by using the short cut <ctrl>+<Z>.

Copy Allows one or more selected items to be copied to the Clipboard ready for pasting into another diagram or compound, or for use in a Watch window, or OPC scope. The original items remain in the current wiring diagram. Short cut = <ctrl>+<C>. If items are pasted to the same diagram from which they were copied, the items will be replicated with different block instances. Should this result in more instances of a block than are available, an error display appears showing details of which items couldn't be copied.

Paste Copies items from the Clipboard to the current wiring diagram. <Ctrl>+<V>. If items are pasted to the same diagram from which they were copied, the items will be replicated with different block instances. Should this result in more instances of a block than are available, a Paste error display appears showing details of which items couldn't be copied.

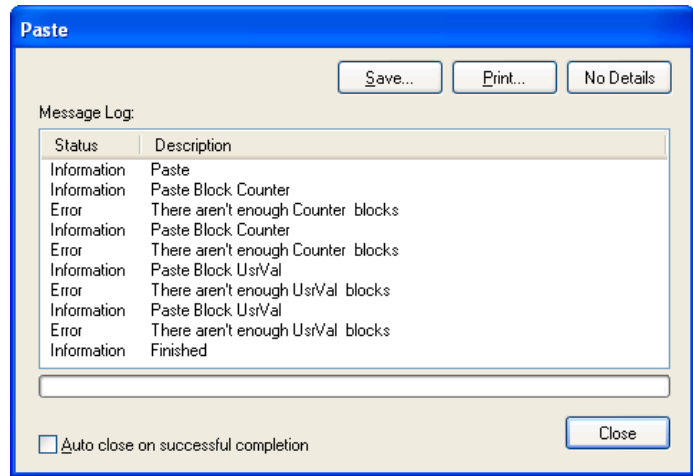

Delete Marks all selected items for deletion. Such items are shown dashed until next download, after which they are removed from the diagram. Short cut = .

Undelete Reverses 'Delete' and 'Cut' operations carried out on selected item(s) since the last download.

Bring To Front Brings selected items to the front of the diagram.

Push To back Sends the selected items to the back of the diagram.

Edit Parameter Value...

This menu item is active if the cursor is hovering over an editable parameter. Selecting this menu item causes a pop-up window to appear, which allows the user to edit the parameter value.

Parameter Properties...

This menu item is active if the cursor is hovering over an editable parameter. Selecting this menu item causes a pop-up window to appear, which allows the user to view the parameter properties, and also, to view the parameter Help (by clicking on the 'Help' tab).

Parameter Help... Produces Parameter Properties and Help information for the selected function block or parameter, depending on the hover position of the cursor, when the right-click occurs.

Wires

To make a wire

1. Drag two (or more) blocks onto the diagram from the function block tree.
2. Start a wire by either clicking on a recommended output or clicking on the 'Click to Select output' icon at the bottom right corner of the block to bring up the connection dialogue, and clicking on the required parameter. Recommended connections are shown with a green plug symbol; other parameters which are available being shown in yellow. Clicking on the red button causes all parameters to be shown. To dismiss the connection dialogue either press the escape key on the keyboard, or click the cross at the bottom left of the dialogue box.
3. Once the wire has started a dashed wire is drawn from the output to the current mouse position. To complete the wire click on the required destination parameter.
4. Wires remain dashed until they are downloaded

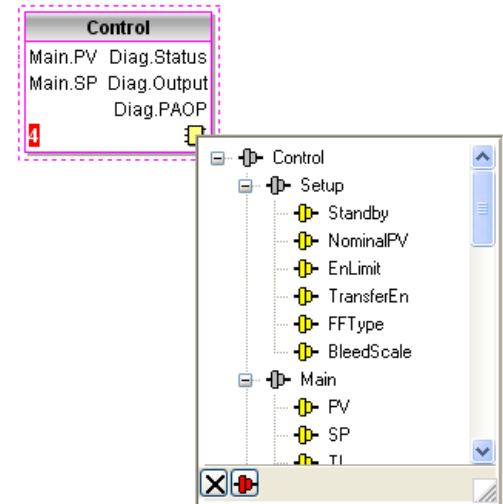

Figure 128 Output selection dialogue box



Routing wires

When a wire is placed it is auto-routed. The auto routing algorithm searches for a clear path between the two blocks. A wire can be auto-routed again using the context menus or by double clicking the wire. A wire segment can be edited manually by click-dragging. If the block to which it is connected is moved, the end of the wire moves with it, retaining as much of the path as possible.

If a wire is selected by clicking on it, it is drawn with small boxes on its corners.

Wire Context Menu

Right click on a wire to display the wire block context menu:

Force Exec Break	When wires form a loop, a break point must be introduced, where the value written to the block comes from a source which was last executed during the previous cycle. A break is automatically placed by iTools, and appears in red.  Force Exec Break allows the user to define where a break must be placed. Surplus breaks appear in black. 
Re-Route wire	Replaces the current wire route with a new route generated from scratch.
Use Tags	Toggles between wire and tag mode between parameters. Tag mode is useful for sources and destinations which are widely separated.
Find Start	Goes to the source of the wire.
Find End	Goes to the destination of the wire.
Cut, Copy, Paste	Not used in this context.
Delete	Marks the wire for deletion. The wire is redrawn as a dashed line (or dashed tags) until next download. Operation can be reversed until after next download.
Undelete	Reverses the effect of the Delete operation up until the next download, after which, Undelete is disabled.
Bring to Front	Brings the wire to the front of the diagram.
Push to Back	Sends the wire to the back of the diagram.

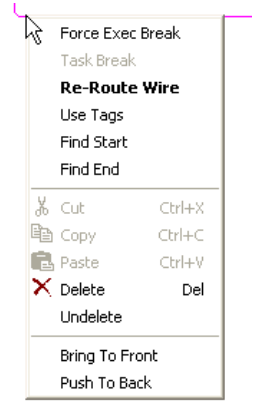

Figure 129 Wire context menu

Wire Colours

Black	Normal functioning wire
Red	The wire is connected to a non-changeable parameter. Values are rejected by the destination block.
Magenta	A normal functioning wire is being hovered-over by the mouse cursor.
Purple	A red wire is being hovered-over by the mouse cursor.
Green	New Wire (dashed green wire changes to solid black after being downloaded.)

Thick Wires

When attempting to wire between blocks which are located in different tasks, if no task break is inserted, then all the affected wires are highlighted by being drawn with a much thicker line than usual. Thick wires still execute, but the results are unpredictable, as the unit cannot resolve the strategy.

Comments

Comments are added to a wiring diagram by click-dragging them from the Function Block tree onto the diagram. As soon as the mouse is released, a dialogue box opens to allow the comment text to be entered.

Carriage returns are used to control the width of the comment. Once text entry is complete, 'OK' causes the comment to appear on the diagram. There are no restrictions on the size of a comment. Comments are saved to the instrument along with the diagram layout information.

Comments can be linked to function blocks and wires by clicking on the chain icon at the bottom right-hand corner of the comment box and then clicking again on the required block or wire. A dashed line is drawn to the top of the block or to the selected wire segment (figure 131).

NOTE: Once the comment has been linked, the Chain icon disappears. It re-appears when the mouse cursor is hovered over the bottom right-hand corner of the comment box, see figure 131.

Comment Context Menu

Edit	Opens the Comment dialogue box to allow the comment text to be edited.
Unlink	Deletes the current link from the comment.
Cut	Moves the comment to the Clipboard, ready to be pasted elsewhere. Short cut = <ctrl>+<X>.
Copy	Copies the comment from the wiring diagram to the Clipboard, ready to be pasted elsewhere. Short cut = <ctrl>+<C>.
Paste	Copies a comment from the Clipboard to the wiring diagram. Short cut = <ctrl>+<V>.
Delete	Marks the comment for deletion at next download.
Undelete	Undoes the Delete command if download has not taken place since.

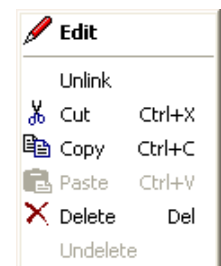

Figure 130 Comment context menu

MONITORS

Monitor points are added to a wiring diagram by click-dragging them from the Function Block tree onto the diagram. A monitor shows the current value (updated at the iTools parameter list update rate) of the parameter to which it is linked. By default the name of the parameter is shown. To hide the parameter name either double click on the monitor box or 'Show Names' in the context (right-click) menu can be used to toggle the parameter name on and off.

Monitors are linked to function blocks and wires by clicking on the chain icon at the bottom right-hand corner of the box and then clicking again on the required parameter. A dashed line is drawn to the top of the block or the selected wire segment.

NOTE: Once the monitor has been linked, the Chain icon disappears. It re-appears when the mouse cursor is hovered over the bottom right-hand corner of the monitor box

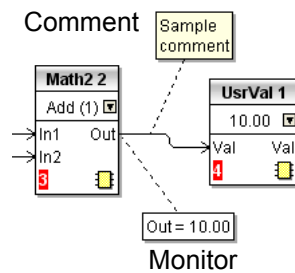

Figure 131 Comment and Monitor appearance

Monitor Context Menu

Show names	Toggles parameter names on and off in the monitor box.
Unlink	Deletes the current link from the monitor.
Cut	Moves the monitor to the Clipboard, ready to be pasted elsewhere. Short cut = <ctrl>+<X>.
Copy	Copies the monitor from the wiring diagram to the Clipboard, ready to be pasted elsewhere. Short cut = <ctrl>+<C>.
Paste	Copies a monitor from the Clipboard to the wiring diagram. Short cut = <ctrl>+<V>.
Delete	Marks the monitor for deletion at next download.
Undelete	Undoes the Delete command if download has not taken place since.
Bring to Front	Moves the item to the 'top' layer of the diagram.
Push to Back	Moves the item to the 'bottom' layer of the diagram.
Parameter Help	Shows parameter help for the item.

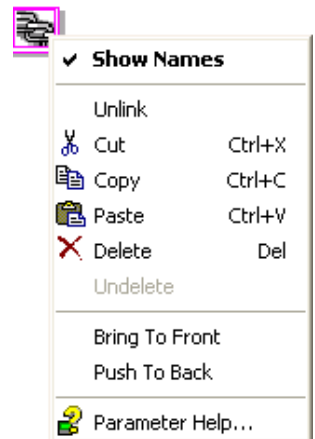

Figure 132 Monitor context menu

Downloading

When the wiring editor is opened the current wiring and diagram layout is read from the instrument. No changes are made to the instrument function block execution or wiring until the download button is pressed. Any changes made using the operator interface after the editor is opened are lost on download.

When a block is dropped onto the diagram, instrument parameters are changed to make the parameters for that block available. If changes are made and the editor is closed without saving them there is a delay while the editor clears these parameters.

During download, the wiring is written to the instrument which then calculates the block execution order and starts executing the blocks. The diagram layout including comments and monitors is then written into instrument flash memory along with the current editor settings. When the editor is reopened, the diagram is shown positioned as it was when it was last downloaded.

Colours

Items on the diagram are coloured as follows:

Red	Items which totally or partially obscure other items and items which are totally or partially obscured by other items. Wires that are connected to unalterable or non-available parameters. Execution breaks. Block execution orders for Task 1.
Blue	Non-available parameters in function blocks. Block execution orders for Task 4. Task breaks.
Green	Items added to the diagram since last download are shown as green dashed lines. Block execution orders for Task 2.
Magenta	All selected items, or any item over which the cursor is hovering.
Purple	Red wires when being hovered over by the mouse cursor.
Black	All items added to the diagram before the last download. Block execution orders for Task 3. Redundant execution breaks. Monitor and comment text.

Diagram context menu

Cut	Active only when the right click occurs within the bounding rectangle which appears when more than one item is selected. Moves the selection off the diagram to the Clipboard. Short cut = <ctrl>+<X>.	
Copy	As for 'Cut', but the selection is copied, leaving the original on the diagram. Short cut = <ctrl>+<C>.	
Paste	Copies the contents of the Clipboard to the diagram. Short cut = <ctrl>+<V>.	
Re-Route wires	Reroutes all selected wires. If no wires are selected, all wires are re-routed.	
Align Tops	Aligns the tops of all blocks in the selected area.	
Align Lefts	Aligns the left edges of all blocks in the selected area.	
Space Evenly	Spaces selected items such that their top left corners are spaced evenly across the width of the diagram. Click on the item which is to be the left-most item, then <ctrl>+<left click> the remaining items in the order in which they are to appear.	
Delete	Marks the item for deletion at next download time. Can be 'Undeleted' up until download occurs.	
Undelete	Reverses the action of 'Delete' on the selected item.	
Select All	Selects all items on the current diagram.	
Create Compound	Active only when the right click occurs, in the top level diagram, within the bounding rectangle which appears when more than one item is selected. Creates a new wiring diagram as described in 'Compound', below.	
Rename	Allows a new name to be entered for the current wiring diagram. This name appears in the relevant tab.	
Copy Graphic	Copies the selected items (or the whole diagram if no items are selected) to the clipboard as a Windows metafile, suitable for pasting into a documentation application. Wiring entering/leaving the selection (if any) are drawn in tag mode.	
Save Graphic...	As for 'Copy Graphic' above, but saves to a user-specified file location instead of the clipboard.	
Copy Fragment To File...	Copies selected items to a user-named file in folder 'My iTools Wiring Fragments' located in 'My Documents'.	
Paste Fragment From File	Allows the user to select a stored fragment for inclusion in the wiring diagram.	
Centre	Places the display window at the centre of the selected items. If 'Select All' has previously been clicked-on, then the display widow is placed over the centre of the diagram.	

Figure 133 Diagram context menu

Compounds

Compounds are used to simplify the top level wiring diagram, by allowing the placing of any number of function blocks within one 'box', the inputs and outputs of which operate in the same way as those of a normal function block.

Each time a compound is created, a new tab appears at the top of the wiring diagram. Initially compounds and their tabs are named 'Compound 1', 'Compound 2', etc. but they can be renamed by right clicking either on the compound in the top level diagram, or anywhere within an open Compound, selecting 'Rename' and typing in the required text string (16 characters max.).

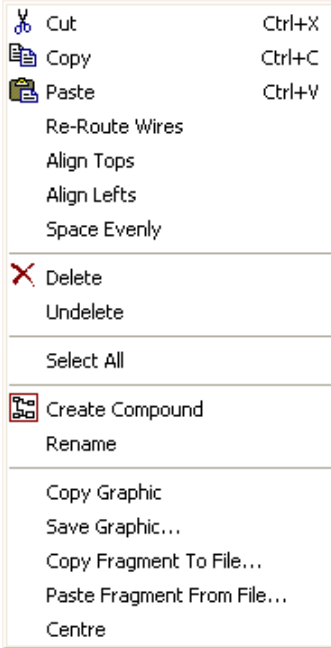
Compounds cannot contain other compounds (i.e. they can be created only in the top level diagram).

Compound creation

1. Empty compounds are created within the top level diagram by clicking on the 'Create Compound' toolbar icon.
2. Compounds can also be created by highlighting one or more function blocks in the top level diagram and then clicking on the 'Create Compound' toolbar icon. The highlighted items are moved from the top level diagram into a new compound.
3. Compounds are 'uncreated' (flattened), by highlighting the relevant item in the top level menu and then clicking on the 'Flatten Compound' toolbar icon. All the items previously contained within the compound appear on the top level diagram.
4. Wiring between top level and compound parameters is carried out by clicking on the source parameter, then clicking on the compound (or the compound tab) and then clicking on the destination parameter. Wiring from a compound parameter to a top level parameter or from compound to compound is carried out in similar manner.
5. Unused function blocks can be moved into compounds by dragging from the tree view. Existing blocks can be dragged from the top level diagram, or from another compound, onto the tab associated with the destination compound. Blocks are moved out of compounds to the top level diagram or to another compound in a similar way. Function blocks can also be 'cut and pasted'.
6. Default compound names (e.g. 'Compound 2') are used only once, so that if, for example, Compounds 1 and 2 have been created, and Compound 2 is subsequently deleted, then the next compound to be created will be named 'Compound 3'.
7. Top level elements can be click-dragged into compounds.

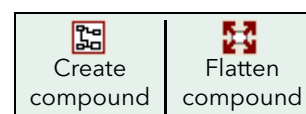

Tool Tips

Hovering the cursor over the block displays 'tooltips' describing that part of the block beneath the cursor. For function block parameters the tooltip shows the parameter description, its OPC name, and, if downloaded, its value. Similar tooltips are shown when hovering over inputs, outputs and over many other items on the iTools screen.

A Function Block is enabled by dragging the block onto the diagram, wiring it, and finally downloading it to the instrument. Initially blocks and associated wires are drawn with dashed lines, and when in this state the parameter list for the block is enabled but the block is not executed by the instrument.

The block is added to the instrument function block execution list when the 'Download' icon is operated and the items are redrawn using solid lines.

If a block which has been downloaded is deleted, it is shown on the diagram in a ghosted form until the download button is pressed. (This is because it and any wires to/from it are still being executed in the instrument. On download it will be removed from the instrument execution list and the diagram.) A ghosted block can be 'undeleted' as described in 'Context menu', above.

When a dashed block is deleted it is removed immediately.

Parameter Explorer

This view is displayed:

1. by clicking on the 'Parameter Explorer' toolbar icon,  Parameter Explorer
2. by double clicking on the relevant block in the tree pane or in the graphical wiring editor
3. by selecting 'Function Block View' from the Function block context menu in the Graphical wiring Editor.
4. by selecting 'parameter Explorer from the 'View' menu
5. by using the short cut <Alt>+<Enter>

In each case the function block parameters appear in the iTools window in tabular form, such as the example in [figure 134](#).

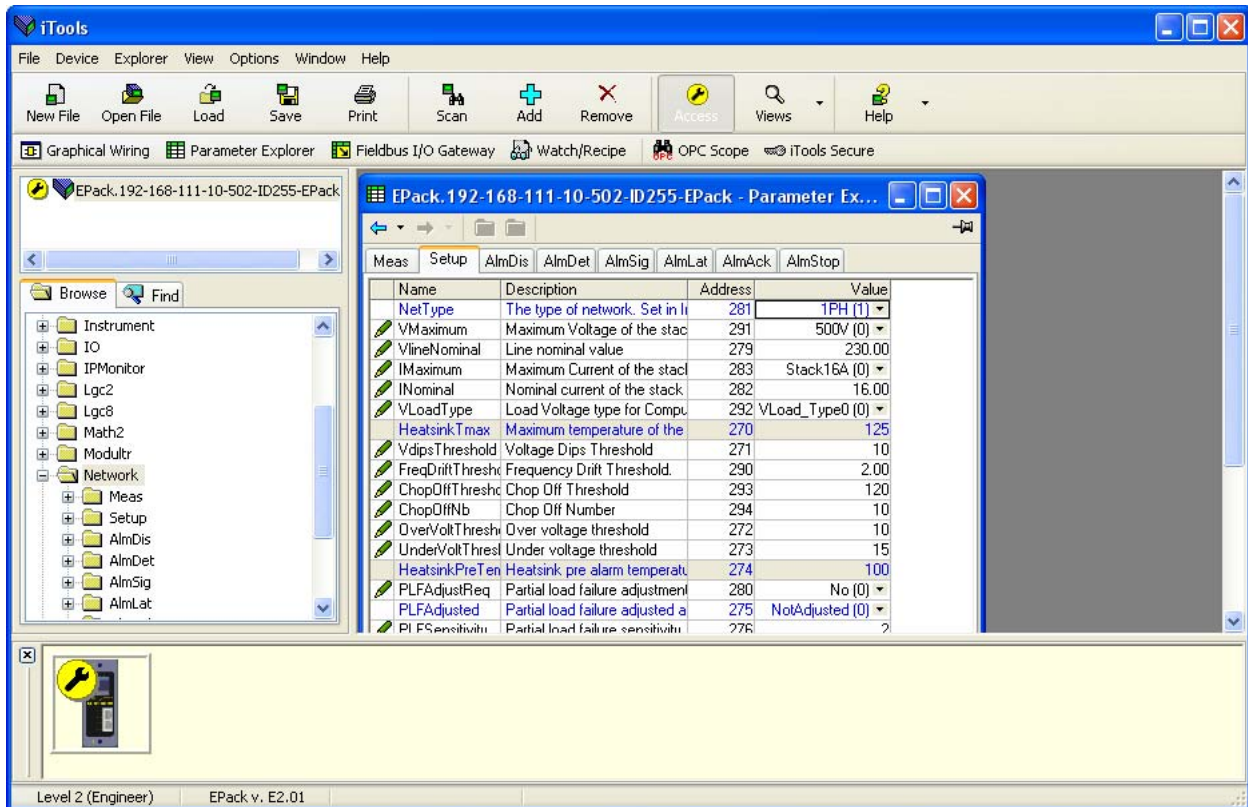

Figure 134 Parameter table example

The figure above shows the default table layout. Columns can be added/deleted from the view using the 'Columns' item of the Explorer or context menus (Figures 135).

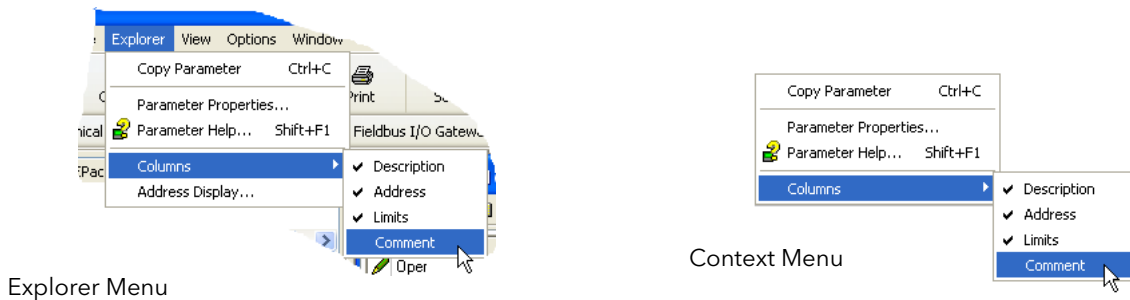

Figure 135 Column enable/disable

Parameter explorer detail

Figure 136 shows a typical parameter table. This particular parameter has a number of subfolders associated with it, and each of these is represented by a 'tab' across the top of the table.

Name	Description	Address	Value	Low Limit	High Limit
Frequency	Frequency of the line	267	0.00	-10000000000.00	10000000000.00
Vline	Line voltage measurement	256	0.00	-10000000000.00	10000000000.00
I	Irms of the load	257	0.00	-10000000000.00	10000000000.00
IsqBurst	Average square value of load	258	0.00	-10000000000.00	10000000000.00
Isq	Square value of the load curri	259	0.00	-10000000000.00	10000000000.00
V	Vrms of the load	260	0.00	-10000000000.00	10000000000.00
VsqBurst	Average square value of the	268	0.00	-10000000000.00	10000000000.00
Vsq	Square value of load voltage	261	0.00	-10000000000.00	10000000000.00
PBurst	True Power measurement in	262	0.00	-10000000000.00	10000000000.00
P	True power measurement.	263	0.00	-10000000000.00	10000000000.00
S	Apparent power measuremer	264	0.00	-10000000000.00	10000000000.00
PF	Power Factor	265	0.00	-10000000000.00	10000000000.00
Z	Load impedance	266	0.00	-10000000000.00	10000000000.00
HtSink Temp	Heatsink 1 temperature	269	0.00	-10000000000.00	10000000000.00

Figure 136 Typical parameter table

NOTES:

- Parameters in blue are non-editable (Read only). In the example above all the parameters are read only. Read/write parameters are in black and have a 'pencil' symbol in the 'read/Write access column at the left edge of the table. A number of such items are shown in figure 134, above.
- Columns. The default explorer window (figure 134) contains the columns 'Name', 'Description', 'Address' and 'Value'. As can be seen from figure 137, above, the columns to be displayed can be selected, to a certain extent, using either the 'Explorer' menu or the context menu. 'Limits' have been enabled for the example above.
- Hidden Parameters. By default, iTools hides parameters which are considered irrelevant in the current context. Such hidden parameters can be shown in the table using the 'Parameter availability' settings item of the options menu (figure 137). Such items are displayed with a shaded background.
- The full pathname for the displayed parameter list is shown at the bottom left hand corner of the window.

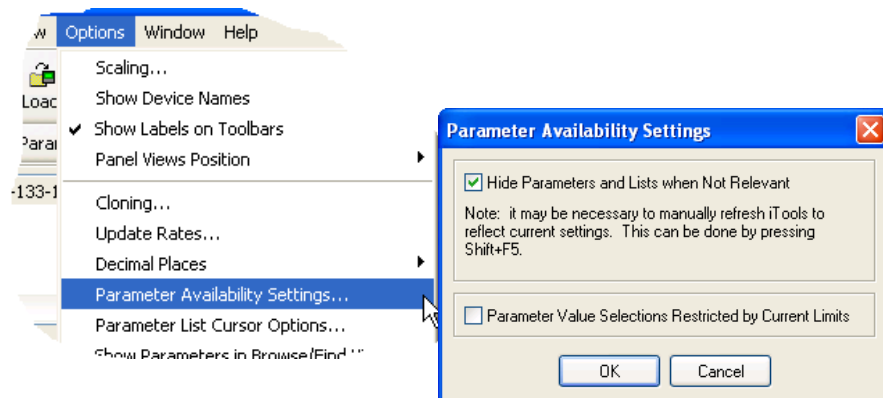





Figure 137 Show/Hide parameters

Explorer tools

A number of tool icons appear above the parameter list:

- 

Back to: and Forward to:
The parameter explorer contains a history buffer of up to 10 lists that have been browsed in the current instance of the window. The 'Back to: (list name)' and 'Forward to: (list name)' icons allow easy retracing or repeating of the parameter list view sequence. If the mouse cursor is hovered over the tool icon, the name of the parameter list which will appear if the icon is clicked-on appears. Clicking on the arrow head displays a pick list of up to 10 previously visited lists which the user can select. Short cut = <ctrl>+ for 'Back to' or <ctrl>+<F> for 'Forward to'.
- 

Go Up a Level, Go Down a Level. For nested parameters, these buttons allow the user to navigate 'vertically' between levels. Short cut = <ctrl>+<U> for 'Go Up a Level' or <ctrl>+<D> for 'Go Down a Level'.
- 

Push pin to give the window global scope. Clicking on this icon causes the current parameter list to be permanently displayed, even if another instrument becomes the 'current device'.

Context Menu

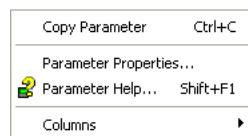

/ Parameter	Copies the clicked-on parameter to the clipboard
meter properties	Displays parameter properties for the clicked-on parameter
meter Help...	Displays help information for the clicked-on parameter
mns	Allows the user to enable/disable a number of parameter table columns (figure 135).

Fieldbus Gateway Fieldbus I/O Gateway

E-Pack controller units contain a great number of parameters, so it is necessary for the user to define which Input and Output parameters are to be available for block read and write. The Input/Output definitions are configured using the 'Fieldbus I/O Gateway'.

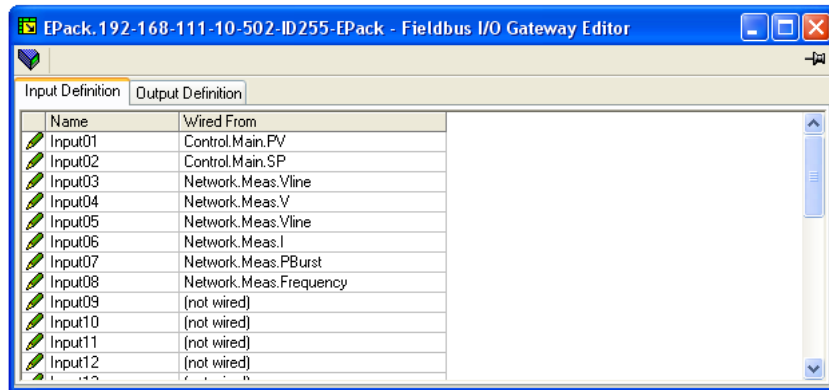

Figure 138 Typical Fieldbus Gateway Parameter list

As shown in figure 138, there are two tabs within the editor, called 'Input definition' and 'Output definition'. 'Inputs' are values sent from the controller to the Profibus master. 'Outputs' are values received from the master and used by the controller, (e.g. set points written from the master).

The procedure for selecting variables is the same for both input and output definition tabs:

1. Double click the next available position in the input or output data table and select the variable to assign to it. A pop-up (figure 139) provides a browser from which a list of parameters can be opened.
2. Double click the parameter to assign it to the input definition.

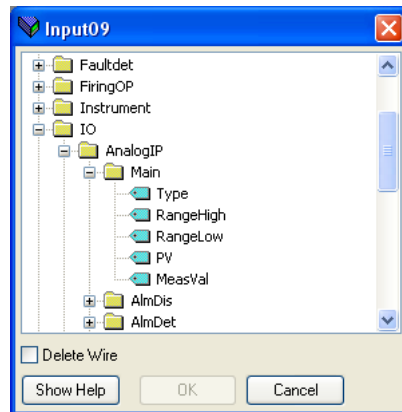

Figure 139 Browser window

NOTES:

1. By setting the same parameter contiguously (e.g. main.sp for inputs 2 and 3) the data will be sent in IEEE format.
2. The Master must request the same number of parameters as there are in the table.
3. The tables are saved to Flash memory when the user quits configuration mode and returns to Operator mode.

When all the required parameters have been added to the lists, notes of how many 'wired' entries are included in the input and output areas should be made as this information is needed when setting up the Master.

NOTES:

1. A maximum of 32 input and 16 output parameters may be set using the Gateway Editor.
2. No checks are made that output variables are writeable, and if a read only variable is included in the output list any values sent to it will be ignored with no error indication.
3. For Modbus only:

As shown in figure 140, 'Block Read' and 'Block Write' requests both access the same memory location (Dec:4744; hex:1288), which 'points' to the relevant input definition table or output definition table according to whether the instruction is a read or a write. The value for a parameter in the input table may differ from the value of the same parameter in the output table.

Once the changes have been made to the Input and Output definition lists, they must be downloaded to the controller unit. This is done (for both tables simultaneously) by clicking on the 'Update device Flash Memory' button on the top left of the Fieldbus Gateway Editor window. The controller performs a restart after this operation.

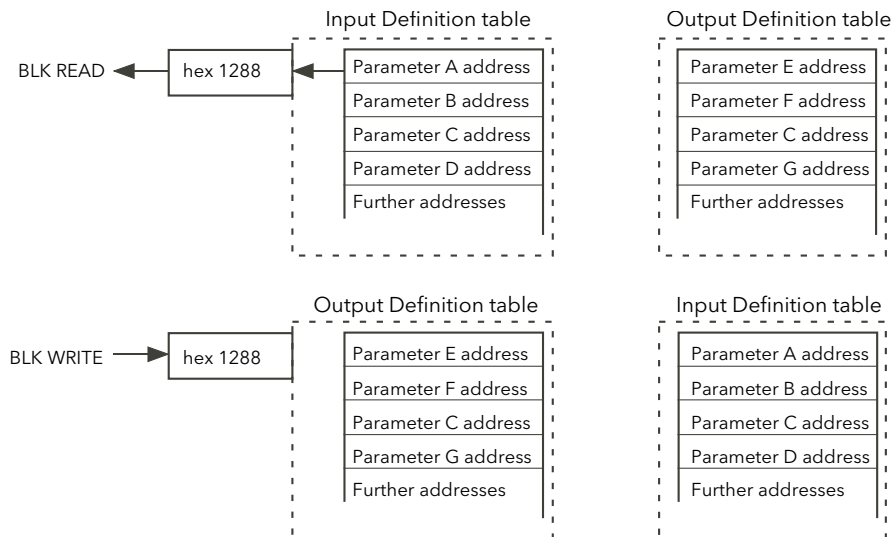

Figure 140 Block read and block write (note 3)

Watch/Recipe Editor Watch/Recipe

The watch/recipe editor is opened by clicking on the Watch/Recipe tool icon, by selecting 'Watch/Recipe' in the 'Views' menu or by using the short cut <ctrl>+<A>. The window is in two parts: the left part containing the watch list; the right-hand part containing one or more data sets, initially empty and unnamed.

The Watch/Recipe window is used:

1. To monitor a list of parameters. This list can contain parameters from many different, and otherwise unrelated parameter lists within the same device. It cannot contain parameters from different devices.
2. To create 'data sets' of parameter values which can be selected and downloaded to the device in the sequence defined in the recipe. The same parameter may be used more than once in a recipe.

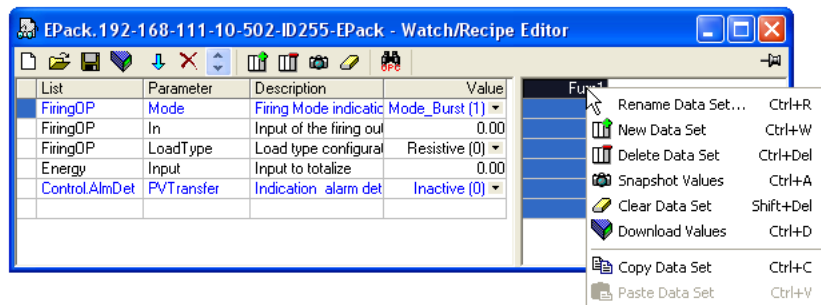



Figure 141 Watch/Recipe Editor window (with context menu)

Creating a Watch List

After opening the window, parameters can be added to it as described below. The values of the parameters update in real-time, allowing the user to monitor a number of values simultaneously.

Adding parameters to the Watch List

1. Parameters can be click-dragged into the watch list from another area of the iTools window (for example, the parameter explorer window, the graphical wiring editor, the browse tree). The parameter is placed either in an empty row at the bottom of the list, or if it is dragged on top of an already existing parameter, it is inserted above this parameter, with the remaining parameters being moved down one place.
2. Parameters can be dragged from one position in the list to another. In such a case, a copy of the parameter is produced, the source parameter remaining in its original position.
3. Parameters can be copied <ctrl>+<C> and pasted <ctrl>+<V> either within the list, or from a source external to it, for example the parameter browse window or the graphical wiring editor.
4. The 'Insert item...' tool button  the 'Insert Parameter' item in the Recipe or context menu or the short cut <Insert> can be used to open a browse window from which a parameter is selected for insertion above the currently selected parameter.

Data Set Creation

Once all the required parameters have been added to the list, select the empty data set by clicking on the column header. Fill the data set with current values using one of the following methods:

1. Clicking on the 'Capture current values into a data set' tool icon  (also known as the 'Snapshot Values' tool).
2. Selecting 'Snapshot Values' from the Recipe or Context (right-click) menu.
3. Using the short cut <ctrl>+<A>.

Individual data values can now be edited by typing directly into the grid cells. Data values can be left blank or cleared, in which case, no values will be written for those parameters at download. Data values are cleared by deleting all the characters in the cell then either moving to a different cell or typing <Enter>.

The set is called 'Set 1' by default, but it can be renamed by either by using the 'Rename data set...' item in the Recipe or context menus, or by using the short cut <ctrl>+<R>.













New, empty data sets can be added using one of the following:

1. Clicking on the 'Create a new empty data set' toolbar icon. 
2. Selecting 'New Data Set' in the Recipe or context menus
3. Using the short cut <ctrl>+<W>

Once created, the data sets are edited as described above.

Finally, once all the required data sets have been created, edited and saved, they can be downloaded the instrument, one at a time, using the Download tool, the 'Download Values' item in the Recipe or context menus, or the short cut <ctrl>+<D>. 

Watch Recipe toolbar icons

-  Create a new watch/recipe list. Creates a new list by clearing out all parameters and data sets from an open window. If the current list has not been saved, confirmation is requested. Short cut <ctrl>+<N>
-  Open an existing watch/recipe file. If the current list or data set has not been saved, confirmation is requested. A file dialogue box then opens allowing the user to select a file to be opened. Short cut <ctrl>+<O>
-  Save the current watch/recipe list. Allows the current set to be saved to a user specified location. Short cut <ctrl>+<S>.
-  Download the selected data set to the device. Short cut <ctrl>+<D>
-  Insert item ahead of selected item. Short cut <Insert>.
-  Remove recipe parameter. Short cut <ctrl>+<Delete>.
-  Move selected item. Up arrow moves selected parameter up the list; down arrow move the selected parameter down the list.
-  Create a new empty data set. Short cut <ctrl>+<w>.
-  Delete an empty data set. Short cut <ctrl>+<Delete>
-  Capture current values into a data set. Fills the selected data set with values. Short cut <ctrl>+<A>.
-  Clear the selected data set. Removes values from the selected data set. Short cut <Shift>+<Delete>.
-  Open OPC Scope. Opens a separate utility that allows trending, data logging and Dynamic Data Exchange (DDE). OPC Scope is an OPC explorer program that can connect to any OPC server that is in the windows registry. (OPC is an acronym for 'OLE for Process Control, where OLE stands for 'Object Linking and Embedding'.)

Watch/Recipe Context Menu

The Watch/Recipe Context menu items have the same functions as described above for toolbar items.

Parameter Addresses (Modbus)

Introduction

The iTools address fields display each parameter's Modbus address to be used when addressing integer values over the serial communications link. In order to access these values as IEEE floating point values, the calculation: IEEE address = {(Modbus address x 2) + hex 8000} should be used.

NOTES:

1. Certain parameters may have values which exceed the maximum value that can be read from or written to using a 16-bit integer communications. Such parameters have a scaling factor applied to them as described in section .
2. When using 16-bit scaled integer modbus addressing, time parameters can be read from or written to in 10ths of minutes, or in 10ths of seconds as defined in the parameter [Instrument.config.TimerRes](#).

Parameter Types

The following parameter types are used:

bool	Boolean
uint8	Unsigned 8-bit integer
int16	Signed 16-bit integer
uint16	Unsigned 16-bit integer
int32	Signed 32-bit integer
uint32	Unsigned 32-bit integer
time32	Unsigned 32-bit integer (time in milliseconds)
float32	IEEE 32-bit floating point
string	String - an array of unsigned 8-bit integers.

Parameter Scaling

Some parameters might have values which exceed the maximum value (32767) that can be read/written via 16-bit scaled integer comms. Such parameters are assigned a scaling factor as described in [Scaling Factor \(page 137\)](#).

Parameter List

The full list of parameters available via the communications link is to be found in the SCADA table supplied as a part of the iTools help system. Individual parameter addresses also appear in each iTools configuration page along with 'enumerations' showing all the possible values that the parameter can take.

To display the parameters list load the Parameter Help file (*Phelp_Epack_Vx.xx.chm*) from the iTools menu;

1. Select Help, Device Help from the iTools menu bar.
2. The Parameter Help file will display.
3. Select the topic Scada from the Content tab.
4. Scroll to the heading List of Parameters in the main window, click EPack parameters.

The EPack Parameters table will display.

Alarms

System Alarms

System alarms are considered to be 'Major Events' which prevent proper operation of the system, and the unit is placed in standby mode.

The following subsections describe each of the possible system alarms.

Missing mains

Supply power is missing.

Thyristor short circuit

A thyristor short circuit leads to current flow even when not firing.

Over temperature

Reserved for future development.

Network dips

This detects a reduction in supply voltage, and if this reduction exceeds a configurable measured value (VdipsThreshold), firing will be inhibited until the supply voltage returns to a suitable value. VdipsThreshold represents a percentage change in supply voltage between successive half cycles, and can be defined by the user in the Network.Setup menu, as described in "[Network Setup configuration](#)" on [page 149](#).

Mains frequency fault

Triggered if the supply voltage frequency strays out of the range 47 to 63 Hz, or if the mains frequency changes, for one cycle to the next, by more than the threshold defined in the Network.Setup menu described in "[Network Setup configuration](#)" on [page 149](#).

The value can be adjusted between 0.9% and 5%, the default value is 2%.

Chop Off alarm

Chop-off alarm will be active when a current threshold is exceeded for more than a pre-defined number of mains periods. This current threshold is user- adjustable from 100% to 400% of unit's nominal current. (to be found in the Network.setup area of configuration ("[Network Setup configuration](#)" on [page 149](#)).

Process Alarms

Process Alarms are related to the application and can be configured either to stop the unit firing (Standby Mode) or to allow operation to continue. Process alarms can also be configured to be latched and if so, they have to be acknowledged before the alarm is considered to be non-active. Alarms cannot be acknowledged until the trigger source has returned to a non-active state.

Total Load Failure (TLF)

No load is connected.

Closed Loop alarm

Closed loop break alarm is currently active.

Alarm input

The alarm input associated with the alarm block is active.

Over current detection

The analogue input over current detection alarm is active.

Over Voltage Alarm

An 'OverVoltThreshold' can be configured in the Network.Setup area of configuration ("[Network Setup configuration](#)" on page 149) as a percentage of VLineNominal. If the VLine voltage rises above this threshold the OverVoltage alarm is set.

NOTE: This Alarm is returned FALSE if the MissingMains Alarm is set.

Under Voltage Alarm

An 'UnderVoltThreshold' can be configured in the Network.Setup area of configuration ("[Network Setup configuration](#)" on page 149) as a percentage of VLineNominal. If the VLine voltage falls below this threshold the UnderVoltage alarm is set.

NOTE: This Alarm is returned FALSE if the MissingMains Alarm is set.

Partial Load Failure (PLF)

This alarm detects a static increase in load impedance by comparing the reference load impedance (as configured by the user) with the actual measured load impedance over a mains cycle (for phase angle firing) and over the burst period (for burst and logic firing).

The sensitivity of the partial load failure measurement can be set to any value between 2 to 6 inclusive, where an entry of 2, for example, means that one half of the elements (or more) must be open circuit in order to trigger the alarm; an entry of 3 means that one third of the elements (or more) must be open circuit in order to trigger the alarm, and so on down to one sixth. All elements must have identical characteristics and identical impedance values and must be connected in parallel).

The relevant parameters (PLFAdjustReq, and PLFSensitivity) are both to be found in Network.Setup, as described in "[Network Setup configuration](#)" on page 149.

Partial Load Unbalance (PLU)

This alarm is applicable only to three-phase load configurations and indicates when the difference between highest and lowest current value reaches a threshold (PLUthreshold) configurable between 5% and 50% of the highest load current. PLUthreshold appears in Network.Setup, as described in "[Network Setup configuration](#)" on page 149.

Indication Alarms

Indication Alarms signal events for operator action if required. Indication alarms cannot be configured to stop power module firing, but they may be latched if required, and if latched, they must be acknowledged for the Signalling Status to return to the normal (non-alarm) state.

Process Value Transfer active

Indicates when a transfer control mode (e.g. $V^2 \leftrightarrow I^2$ P $\leftrightarrow I^2$ or $V^2 \leftrightarrow I^2$) is active.

Limitation active

Indicates when the internal firing control loop limits the firing output (I^2 or V^2) (in order not to exceed the adjusted maximum value)

Load Over-Current

Indicates when a configurable RMS load current threshold (OverIthreshold) is reached or exceeded. The parameter is found in the Network.Setup area of configuration ("[Network Setup configuration](#)" on page 149) and is configurable as 10% to 400% of Nominal Current.

Maintenance

Precautions

Branch-circuit Protection and Safety Overload Protection

This product does not contain any branch-circuit protection or internal safety overload protection. It is the responsibility of the user to add branch-circuit protection upstream of the unit. It is also the responsibility of the user to provide external or remote safety overload protection to the end installation. Such branch-circuit and safety overload protection must comply with applicable local regulations.

UL: The above mentioned branch-circuit protection is necessary for compliance with National Electric Code (NEC) requirements.

DANGER

1. The manufacturer shall not be held responsible for any damage, injury, losses or expenses caused by inappropriate use of the product or by failure to comply with the instructions in this manual. It is the responsibility of the user to check, before commissioning the unit, that all nominal characteristics correspond to the conditions under which it is to be installed and used.
2. The product must be commissioned and maintained by suitably qualified personnel, authorized to work in an industrial Low Voltage environment.
3. Voltage of over 500V RMS may exist in and around the units, even when they are not 'running'. Ensure that all sources of hazardous voltages are isolated from the units before carrying out any work on the units.
4. The heat sink becomes hot whilst the unit is running, and it can take up to 15 minutes to cool after the unit is shut down. Touching the heat sink, even briefly, must be avoided whilst the unit is operating.

Failure to follow these instructions will result in death, serious injury or equipment damage.

Preventive Maintenance

Please read the warnings above, before attempting to carry out any work on the unit(s).

1. Periodically check that all power and protective earth cable connections are correctly tightened see [Connection Details \(page 28\)](#). This check should include the protective earth ground connections to the cabinet.
2. To maintain maximum cooling efficiency, the Power Module heat-sink must be cleaned regularly. Periodicity depends on the local environment, but should not exceed six months.

Fusing

According to the CE and UL certifications, high speed fuses (supplemental fuses) are mandatory for compliant installation and protection of the EPack power controller against short circuit. The power circuit shall be protected by a supplementary fuse, which should be used in conjunction with suitable fuse holders (and contact kits, if required) as shown in table 8.

With a supplementary fuse (high speed fuse), EPack is suitable for use on a circuit capable of delivering not more than 100kA RMS symmetrical amperes, 500 Volts Maximum (coordination Type 2).

NOTE: Coordination Type 1 and Type 2 explanations.

Type 1: Type 1 coordination requires that, under short-circuit conditions, the device shall cause no danger to persons or to the installation and may not be suitable for further service without repair and replacement of parts.

Type 2: Type 2 coordination requires that, under short-circuit conditions, the device shall cause no danger to persons or to the installation and shall be suitable for further use.



DANGER

The EPack unit's rated short-circuit conditional current is 100kA for co-ordination type 2.

Nevertheless, if opening of either the protective branch circuit or the supplemental (high speed) fuses occurs, the product shall be examined by suitably qualified personnel and replaced if damaged.

Failure to follow these instructions will result in death, serious injury or equipment damage.

EPack nominal current	Required fuse rating	Blown fuse indicator?	Fuse body size (mm)	Eurotherm part numbers		
				Fuse	Fuse holder	Contact kit
≤ 25A	32A	no	10 × 38	CS031505U002	HUA43297	n/a
		yes	14 × 51	CS031506U002	HUA43298	CP177220
32A	40A	no	14 × 51	CS031507U002	HUA43298	n/a
		yes	14 × 51	CS031508U002	HUA43298	CP177220
40A	50A	no	14 × 51	CS031509U002	HUA43298	n/a
		yes	14 × 51	CS031510U002	HUA43298	CP177220
50A	63A	no	22 × 58	CS031511U002	HUA43300	n/a
		yes	22 × 58	CS031512U002	HUA43300	CP177221
63A	80A	no	22 × 58	HUA42588	HUA43300	n/a
		yes	22 × 58	HUA42589	HUA43300	CP177222
80A	200A	no	27 × 60	n/a	n/a	n/a
		yes	27 × 60	CS032166U002	HUA43303	CP177222
100A	200A	no	27 × 60	n/a	n/a	n/a
		yes	27 × 60	CS032166U002	HUA43303	CP177222
125A	200A	no	27 × 60	n/a	n/a	n/a
		yes	27 × 60	CS032166U002	HUA43303	CP177222

Table 8: Details of fuses, fuse holders and contact kits required for EPack

Fuse holder dimensions

Figures 142 to 143 show dimensional details for the various fuse holders listed in table 8 (not all shown to the same scale).

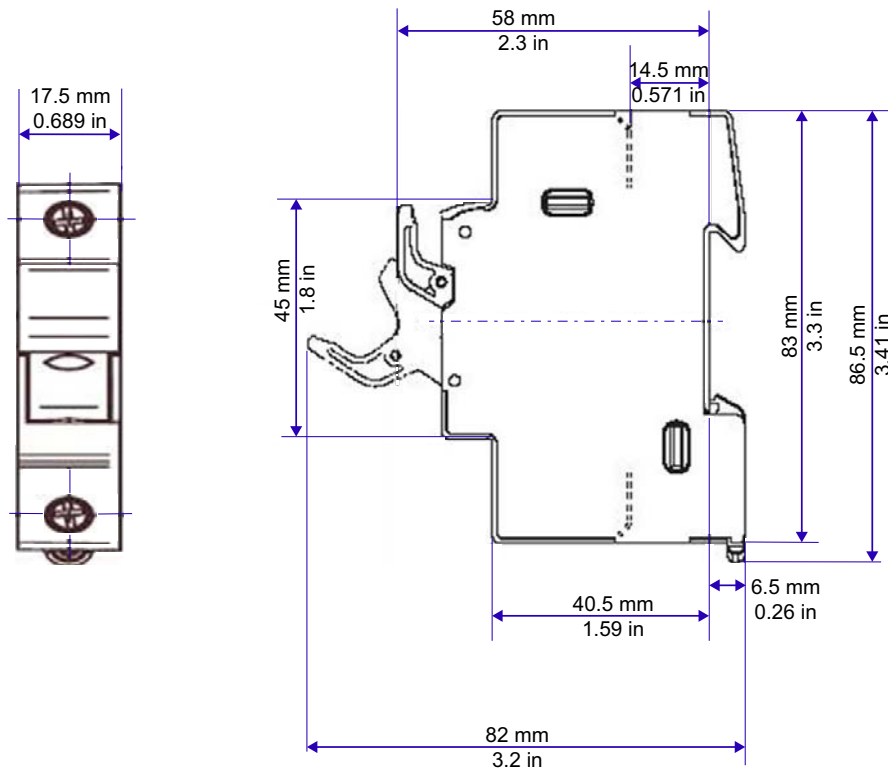

Figure 142 Fuse holder dimensions: HUA43297

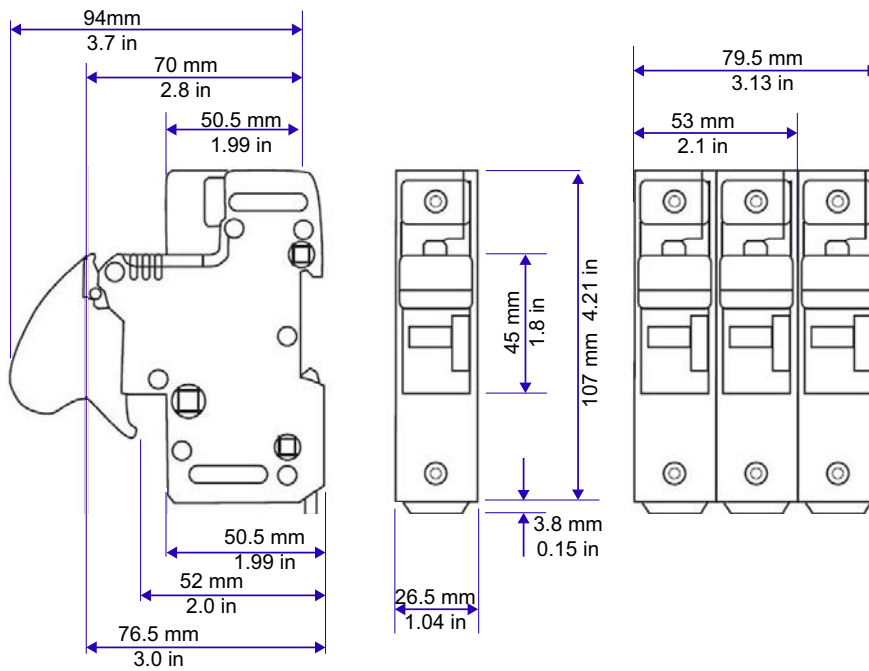

Figure 143 Fuse holder dimensions: HUA43298

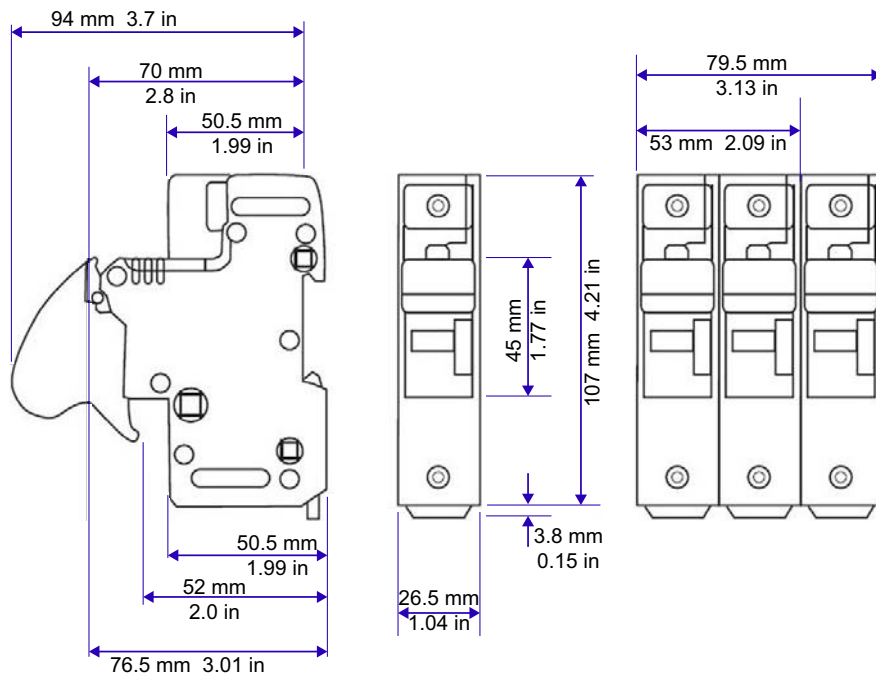

Figure 144 Fuse holder dimensions: HUA43300

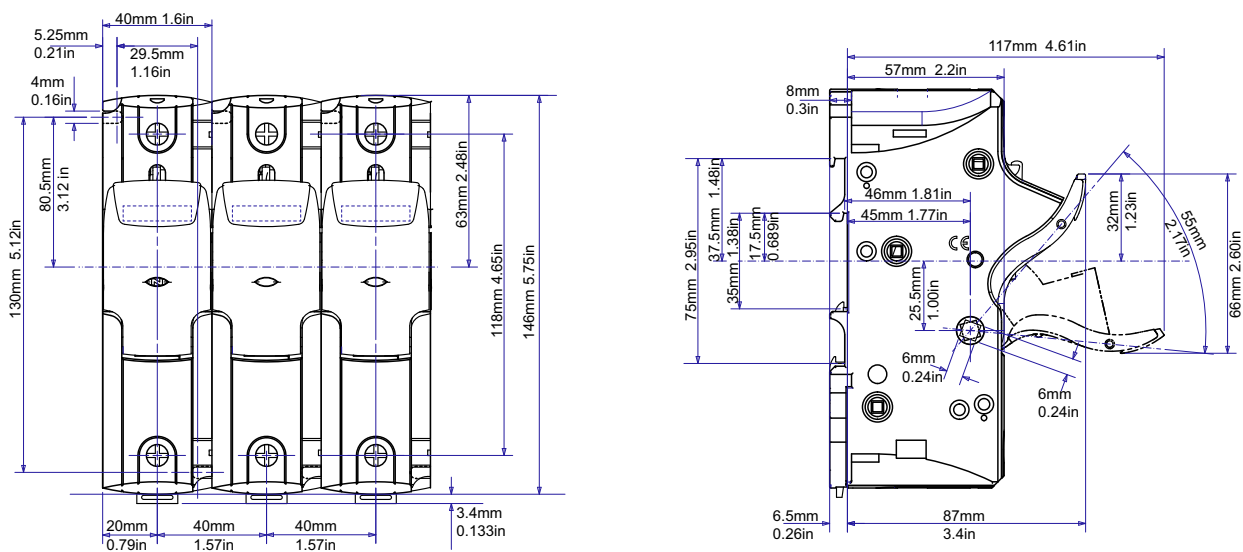

Figure 145 Fuse holder dimensions: HUA43303

Instrument upgrade

Instrument upgrade is done in three steps: upgrading iTools to the latest version, upgrading firmware and upgrading software.

iTools upgrade

On the www.Eurotherm.com website, locate the 'Downloads' section, and click the 'Quick search' button for ITOOLS. A list of the latest available iTools software and documentation is displayed. Click on the links to download and install the latest version.

The screenshot shows the Eurotherm website's 'Downloads' page. At the top, there is a navigation bar with 'Home', 'Latest Articles', 'Events', 'Training', 'Case Studies & Success', and 'Compare'. Below this is a green header with the Eurotherm logo and 'by Schneider Electric'. A search bar is present with the text 'Customer support Technical helpdesk' and a search icon. The main navigation menu includes 'PRODUCTS', 'INDUSTRIES', 'SYSTEMS', 'SUPPORT & SERVICES', 'DOWNLOADS' (highlighted), and 'CONTACT US'. The page title is 'Downloads'. Below the title, there is a 'Quick search:' section with buttons for 'SOFTWARE', 'ITOOLS', and '6000 TOOLS'. A search input field contains 'iTools' and has a search icon and a language dropdown set to 'English'. Below the search field, there is a 'Filter by' section with buttons for 'Brochure', 'User Guides', and 'Software'. A table displays search results:

File Name	Size	Added ^
Eurotherm iTools v9.67 (October 2016)	211.27MB	10/10/2016
iTools EuroMBus OPC Server Startup Registry Settings (TIS208)	164.18KB	01/04/2015

An arrow points from the text 'Click to download the latest version' to the link 'Eurotherm iTools v9.67 (October 2016)'. A yellow button labeled 'Ask a Question' is visible on the right side of the page.

Figure 146 Downloads section

Firmware upgrade

With the relevant instrument selected in iTunes, click on the Help menu and select 'Check for Updates...'.
Click on 'Firmware Upgrade Tool...' and follow the instructions.

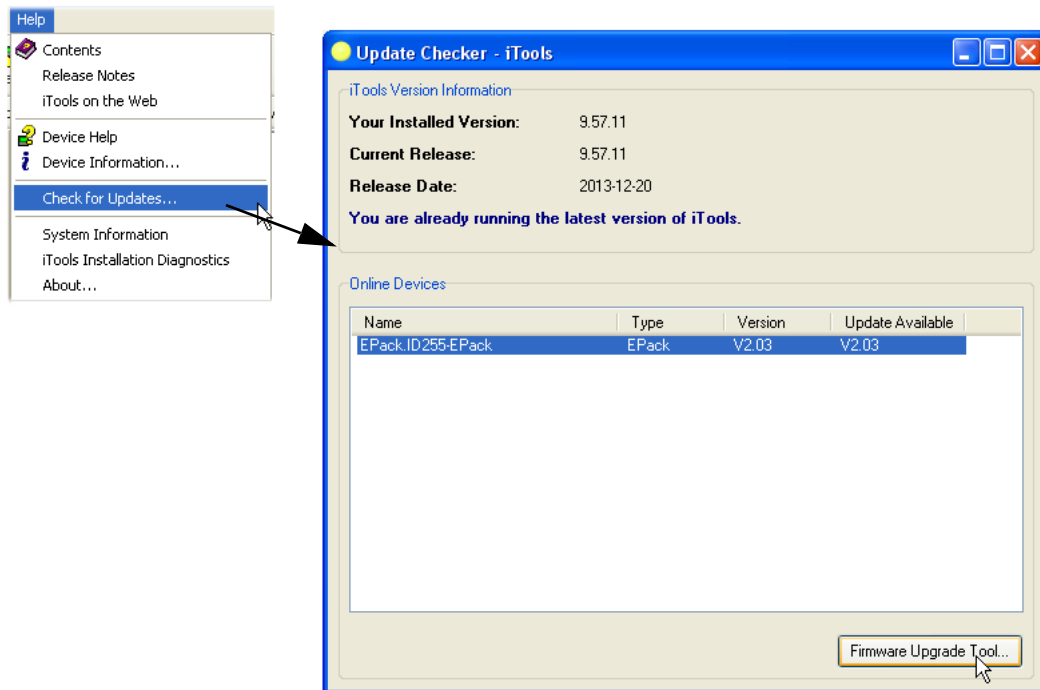
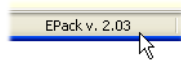

Figure 147 Check for updates

Software upgrade

Software upgrade can be carried out by one of two methods, as follows:

Obtaining a Passcode via Telephone



1. Telephone the local Eurotherm Sales/Service agent with the serial number of the instrument to be updated, and the current software version. The serial number is to be found on the side label of the instrument; the software version at the bottom of the iTools window, as shown.

2. Place an order for the required new functionality.
3. A new passcode will be provided which is to be entered in the Instrument Options configuration.

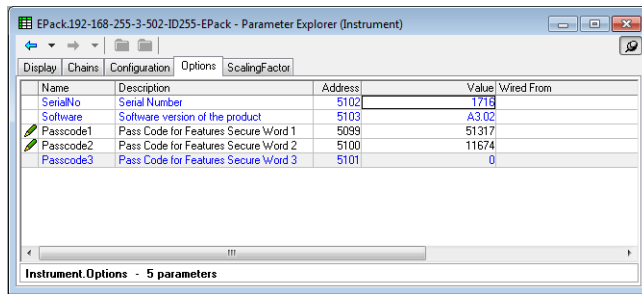
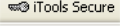

Figure 148 Instrument options configuration

Obtaining a Passcode via itools

1. Click on the 'iTools Secure' tool button .
2. Accept the warning.
3. Select the functions required from the displayed list (figure 149).
4. Click on 'Proceed...'. This sends an email requesting the option passcode. Follow the instructions.
5. Enter the new passcode as described in step three above.

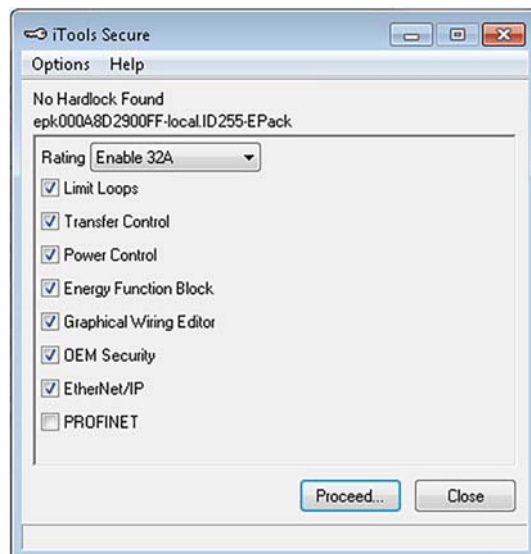

Figure 149 iTools secure

EPack Licence Notice

FreeRTOS

EPack is powered by an original FreeRTOS from version v7.1.0.

FreeRTOS is available at <http://www.freertos.org>

EtherNet/IP

EPack uses an embedded MOLEX Ethernet/IP stack.

PROFINET

EPack uses an embedded PROFINET PORT stack.

/* microutf8

Copyright © 2011 by Tomasz Konojacki

Permission is hereby granted, free of charge, to any person obtaining a copy of this software and associated documentation files (the "Software"), to deal in the Software without restriction, including without limitation the rights to use, copy, modify, merge, publish, distribute, sublicense, and/or sell copies of the Software, and to permit persons to whom the Software is furnished to do so, subject to the following conditions:

The above copyright notice and this permission notice shall be included in all copies or substantial portions of the Software.

THE SOFTWARE IS PROVIDED "AS IS", WITHOUT WARRANTY OF ANY KIND, EXPRESS OR IMPLIED, INCLUDING BUT NOT LIMITED TO THE WARRANTIES OF MERCHANTABILITY, FITNESS FOR A PARTICULAR PURPOSE AND NONINFRINGEMENT. IN NO EVENT SHALL THE AUTHORS OR COPYRIGHT HOLDERS BE LIABLE FOR ANY CLAIM, DAMAGES OR OTHER LIABILITY, WHETHER IN AN ACTION OF CONTRACT, TORT OR OTHERWISE, ARISING FROM, OUT OF OR IN CONNECTION WITH THE SOFTWARE OR THE USE OR OTHER DEALINGS IN THE SOFTWARE.

/*

lwip

/*

* Copyright © 2001, 2002 Swedish Institute of Computer Science.

* All rights reserved.

* Redistribution and use in source and binary forms, with or without modification, are permitted provided that the following conditions are met:

* 1. Redistributions of source code must retain the above copyright notice, this list of conditions and the following disclaimer.

* 2. Redistributions in binary form must reproduce the above copyright notice, this list of conditions and the following disclaimer in the documentation and/or other materials provided with the distribution.

* 3. The name of the author may not be used to endorse or promote products derived from this software without specific prior written permission.

Technical Specification

Standards

The product is designed and produced to comply with:

- EN60947-4-3:2014 (Low-voltage switchgear and controlgear — Part 4-3: Contactors and motor-starters — AC semiconductor controllers and contactors for non-motor loads (identical to IEC60947-4-3:2014
- UL60947-4-1 CAN/CSA C22.2 NO.60947-4-1-14 Low-Voltage Switchgear and Controlgear - Part 4-1: Contactors and Motor-Starters – Electromechanical Contactors and Motor-Starters

Other applicable standards are cited where appropriate.

- Russian Approvals: EAC approval and Pattern Approval (pending)

Installation Categories

General installation category details are summarized in the table below.

	Installation Category	Rated impulse withstand voltage (Uimp)	Rated insulation voltage
Communications	II	0.5 kV	50 V
Standard IO	II	0.5 kV	50 V
Relays	III	4 kV	230 V
Unit Power	III	6 kV	500 V

Table 9: Installation categories

Physical

Dimensions and fixing centres	See figure 4 , figure 5 , figure 6 and figure 7 for details	
Weight	16 to 32A units	2530g + user connectors
	40 to 63A units	2970g + user connectors
	80A and 100A units	5830g + user connectors
	125 A units	7940g + user connectors

Environment

Temperature limits	Operating:	0°C to 45°C at 1000m 0°C to 40°C at 2000m
Storage:		-25°C to +70°C
Altitude		1000 m maximum at 45°C
		2000 m maximum at 40°C
Humidity limits		5% to 95% RH (non-condensing)
Protection (CE)	All units:	IP20 (EN60529) ¹
Protection (UL)	All units:	Open type
Atmosphere		Non-explosive, non-corrosive, non-conductive
External wiring	General:	Must comply with IEC60364-1 and IEC60364-5-54 and all applicable local regulations. Cross sections must comply with Table 9 of IEC60947-1.
	UL:	Wiring must comply with NEC and all applicable local regulations. Cross sections must comply with NEC, Article 310 Table 310-16.(see Table 1 of this manual for temperature ratings)
Shock		To (EN60068-2-27) and IEC60947-1 Annex Q
Vibration (EN60068-2-6) ¹		To (EN60068-2-6) and IEC60947-1 Annex Q
EMC Standard:		EN60947-4-3:2014. See Table 10 , for EMC Immunity Test ratings.

1.In order to maintain IP20 rating, the wiring and installation requirements defined in section [Auxiliary supply \(page 30\)](#) must be adhered.

EMC immunity tests (According to EN60947-4-3:2014)				
	Level		Criteria	
	Requested	Achieved	Requested	Achieved
Electrostatic discharge (test method of IEC 61000-4-2)	Air discharge mode 8kV Contact discharge mode 4kV	Air discharge mode 8kV Contact discharge mode 4kV	2	2
Radiated radio-frequency electromagnetic field test (test method of EN 61000-4-3)	10V/m from 80MHz to 1GHz and from 1,4GHz to 2GHz	15V/m from 80MHz to 3GHz	2	1
Fast transient/burst test (5/50 ns) (test method of EN 61000-4-4)	Power ports 2kV / 5kHz Signal ports 1kV / 5kHz	Power ports 4kV / 5 kHz Signal ports 4kV / 5 kHz	2	2
Surge Voltage test (1,2/50 μs – 8/20 μs) (test method of EN 61000-4-5)	2kV line to earth 1kV line to line	2kV line to earth 1kV line to line	2	2
Conducted radio-frequency test (test method of EN 61000-4-6)	10V (140dBμV) from 0,15MHz to 80 MHz	15V (143.5dBμV) from 0,15MHz to 80 MHz	1	1
Voltage dips test (test method of EN 61000-4-11)	0% during 0.5 cycle & 1 cycle	0% during 0.5 cycle & 1 cycle	2	2
	40% during 10/12 cycles	40% during 10/12 cycles	3	2
	70% during 25/30 cycles	70% during 25/30 cycles	3	2
	80% during 250/300 cycles	80% during 250/300 cycles	3	2
Short interruptions test (test method of EN 61000-4-11)	0% during 250/300 cycles	0% during 250/300 cycles	3	2

Table 10: EMC immunity tests

EMC emission tests (According to EN60947-4-3:2014)				
Test	Frequency (MHz)	Limit level for class A industrial		Comments
		Quasi peak dB (μV)	Average dB (μV)	
Radiated radio frequency emission test According to EN60947-4-3:2014 (test method of CISPR11)	30 to 230	40 at 10m	N/A	Pass
	230 to 1000	47 at 10m	N/A	
Conducted radio frequency emission test According to EN 60947-4-3:2014 for rated power >20 kVA (test method of CISPR11)	0.15 to 0.5	79	66	The conducted emissions can meet the requirement of IEC60947-4-3:2014 with an external filter added on the line connections. This is in line with the rest of the industry ¹
	5 to 30	73	60	
Conducted radio frequency emission test According to EN 60947-4-3:2014 for rated power >20kVA (test method of CISPR11)	0.15 to 0.5	100	90	
	0.5 to 5 5 to 30	86 90 to 73	76 80 to 60	
NOTE: This product has been designed for environment A (Industrial). Use of this product in environment B (domestic, commercial and light industrial) may cause unwanted electromagnetic disturbances in which cases the user may be required to take adequate mitigation measures.				

1. Technical note TN1618 (available upon customer request) describes the recommended filter structures which reduce conducted radio-frequency emissions.

Table 11: EMC emission tests

Operator Interface

Display	1.44" square TFT colour display allowing viewing of selected parameter values in real time, plus configuration of instrument parameters for users with adequate access permission.
Push buttons	Four push buttons provide page and item entry and scroll facilities.

Inputs/Outputs

All figures are with respect to 0V, unless otherwise stated.

Number of inputs/outputs	1 Analogue input; 2 Digital inputs (DI1 and DI2); 1 Relay output 1 User configured output (DI2 input) * (* Exclusive to DI2 when not used as an digital input). See I/O Input & Output Details (page 38)
Update rate	Twice the mains frequency. Defaults to 55 Hz (18 ms) if the supply frequency lies outside the range 47 to 63Hz.)
Termination	Removable 5-way connector. (5.08 mm. pitch) located as shown in figure 12 .

Analogue Input

Performance	See Table 12 and Table 13
Input type	Configurable as one of: 0 to 10V, 1 to 5V, 2 to 10V, 0 to 5V, 0 to 20mA, 4 to 20mA
Absolute input maxima	±16V or ±40mA

Analogue input: Voltage input performance		
Parameter	Typical	Max/Min
Total voltage working input span		0V to +10V
Resolution (noise free) (note 1)	11 bits	
Calibration error (notes 2, 3)	<0.1%	<0.1%
Linearity error (note 2)		±0.1%
Ambient temperature error (note 3)		<0.01%/°C
Input resistance (terminal to 0V)	142kΩ	±0.2%

Note 1: w.r.t. total working span
Note 2: % of effective range (0 to 5V, 0 to 10V)
Note 3: After warm up. Ambient = 25 °C

Table 12: Analogue input specification (voltage inputs)

Analogue input: Current input performance		
Parameter	Typical	Max/Min
Total current working input span		0 to +25mA
Resolution (noise free) (note 1)	11 bits	
Calibration error (notes 2, 3)		<0.2%
Linearity error (note 2)		±0.1%
Ambient temperature error (note 2)		±0.01%/°C
Input resistance (terminal to 0v)	<102Ω	±1%

Note 1: w.r.t. total working span
Note 2: % of effective range (0 to 20mA)
Note 3: After warm up. Ambient = 25 °C

Table 13: Analogue input specification (current inputs)

Digital Inputs

Voltage inputs

Active level (high): $11V < V_{in} < 30V$ with $6mA < \text{input current} < 30mA$
 Non-active level (low): $-3V < V_{in} < 5V$ with $2mA < \text{input current} < 30mA$
 Or
 $5V < V_{in} < 11V$ with input current $< 2mA$

Contact closure inputs

Source current: 10mA min; 15mA max
 Open contact (non active)
 resistance: $> 800\Omega$
 Closed contact (active)
 resistance: $< 450\Omega$

Absolute Maxima: $\pm 30V$ or $\pm 25mA$

NOTE:

1. Absolute maximum ratings refer to externally applied signals.

Digital Output

User configured output (DI2): $\pm 2\%$ 10.2V, 10mA
 For example; To supply a potentiometer between $2k\Omega - 10k\Omega$ ($\pm 20\%$) used to drive the Analogue Input when set to Voltage mode - see [Inputs/Outputs \(page 205\)](#).

Relay Specification

The relay has gold plated contacts suitable for 'dry circuit' (low current) use. See Pinouts [figure 13](#).

Contact life

Resistive loads: 100,000 operations
 Inductive loads: Derate as per accompanying graph ([figure 150](#))

High power use

Current: 2A (resistive loads)
 Voltage: $< 264V$ RMS (UL: voltage 250Vac.)

Low power use

Current: > 10 mA
 Voltage: $> 5V$

Contact configuration:

Single pole change-over (one set of Common, Normally Open and Normally Closed contacts)

Termination

Removable 3-way connector. (5.08 mm. pitch) located as shown in [figure 12](#).

Installation Category

Installation category III, assuming that nominal phase to earth voltage is $\leq 300V$ RMS.

Absolute max. switching capability

$< 2A$ at 240V RMS (resistive loads)

NOTE: 'Normally Closed' and 'Normally Open' refer to the relay when the coil is not energised.

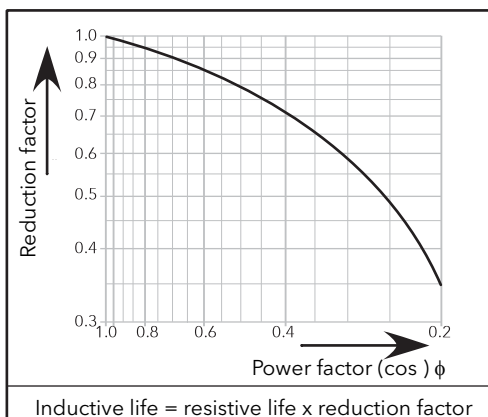

Figure 150 Relay derating curves

Mains Network Measurements

All network measurements are calculated over a full mains cycle, but internally updated every half-cycle. For this reason, power control, current limits and alarms all run at the mains half-cycle rate. The calculations are based on waveform samples taken at a rate of 20kHz. The phase voltage referred to is the line voltage referenced to L3 input potential.

The parameters below are directly derived from measurements for each phase.

Accuracy (20 to 25°C)

- Line frequency (F): ±0.02Hz
- Line RMS voltage (Vline): ±2% of Nominal Vline.
- Load RMS voltage (V): ±2% of Nominal V for voltage readings >1% of Nominal V. Unspecified for readings lower than 1%Vnom.
- Load current (I_{RMS}): ±2% of Nominal I_{RMS} for current readings >3.3% of Nominal I_{RMS}. Unspecified for readings ≤ 3.3% of Nominal. I_{RMS}.
- Load RMS voltage squared (Vsqr): ±2% of (Nominal V)²
- Thyristor RMS current squared (Isqr): ±2% of (Nominal I)²
- True load power (P): ±2% of (Nominal V) × (Nominal I)
- Frequency resolution 0.1 Hz
- Measurement resolution 11 bits of Nominal value (noise free)
- Measurement drift with ambient temp. <0.02% of reading / °C

Further parameters (S, PF, Z, IsqBurst, Vsqr Burst, and PBurst) are derived from the above, for the network (if relevant). See "Network Meas Menu" on page 147 for further details.

Communications

- Connection Dual port Ethernet - RJ45
- Cable type Shielded RJ45 CAT5+
- Protocol Modbus TCP, EtherNet/IP, or PROFINET (both, a chargeable option)
- Baud rate 10/100 full or half duplex
- Indicators Tx activity (green) and communications activity (yellow)



Scan for local contents

Eurotherm Ltd

Faraday Close
Durrington
Worthing
West Sussex
BN13 3PL
Phone: +44 (0) 1903 268500
www.eurotherm.co.uk

As standards, specifications, and designs change from time to time, please ask for confirmation of the information given in this publication.

© 2016 Eurotherm Limited. All Rights Reserved.

HA032715 Issue 01 (CN35047)